



Optimization of Large-Scale Virtual Power Plants Integrating Wind Farms

Luca SANTOSUOSSO¹, Simon CAMAL¹, Arthur LETT²,
Guillaume BONTRON², Georges KARINIOTAKIS¹

¹MINES Paris PSL, ²Compagnie Nationale du Rhône

April 26th, 2023

WindEurope Annual Event 2023

CONCEPT OF VIRTUAL POWER PLANT

An effective **energy management strategy** is required to operate a **Virtual Power Plant (VPP)**.

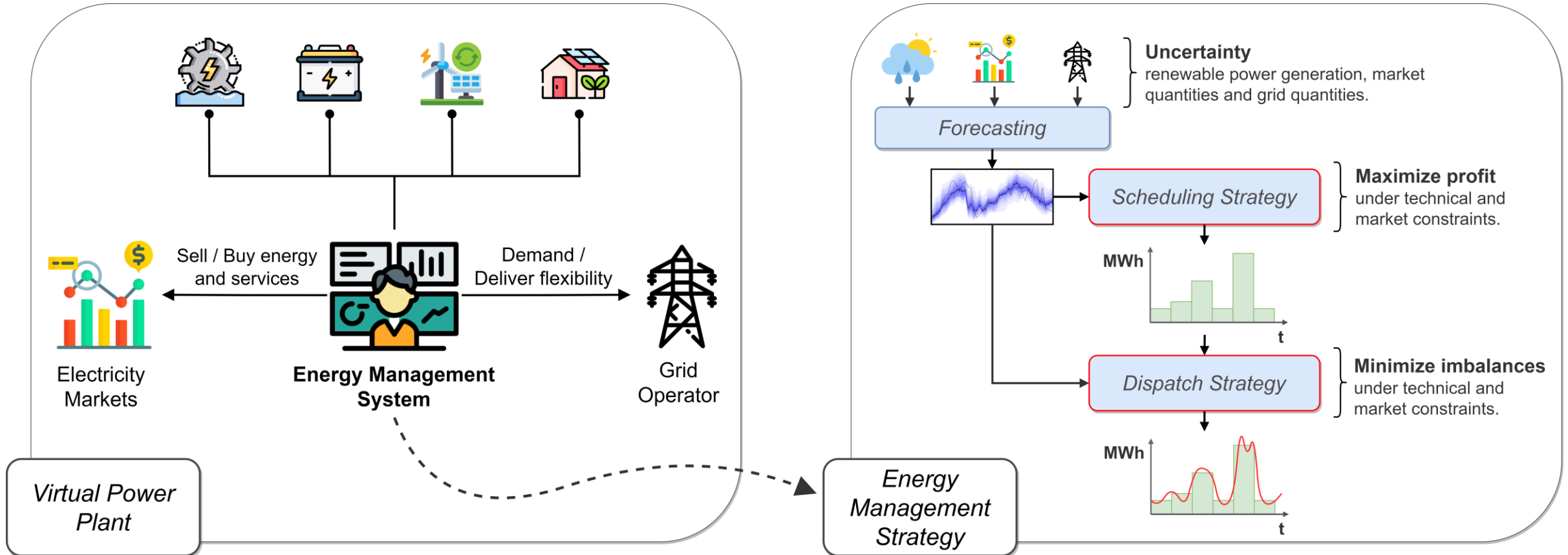

ENERGY MANAGEMENT STRATEGY

At present, most of VPPs are operated with **fully centralized energy management strategies**. Is this the best approach?

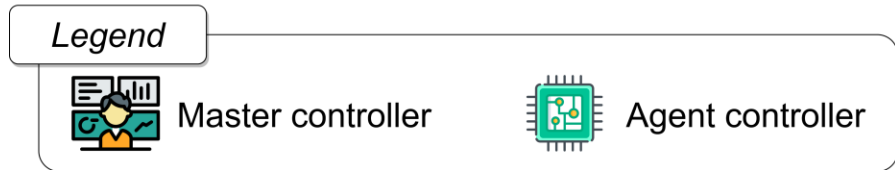
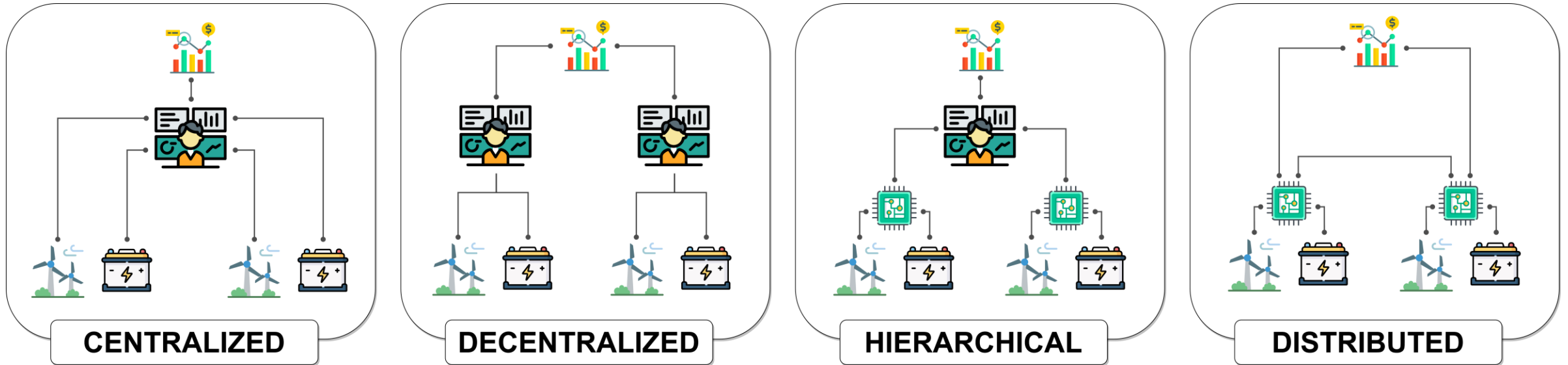

OBJECTIVES AND METHODOLOGY

What do we want to do?

Explore various optimization-based energy management strategies, built respectively on centralized, decentralized, distributed and hierarchical optimization.

Then, discuss these strategies in terms of optimality, scalability, privacy and resilience.

How we do it?

1. Present the known properties of each energy management strategy.
2. Formulate a case study based on real data.
3. Show a problem decomposition which is suitable to the application of hierarchical and distributed approaches.
4. Present results.
5. Derive final conclusions.

STRATEGIES COMPARISON

Energy management strategies can be compared in terms of several properties, e.g., optimality, scalability, privacy and resilience.

PROPERTY	CENTRALIZED	DECENTRALIZED	HIERARCHICAL	DISTRIBUTED
OPTIMALITY	★ ★ ★	★	★ ★	★ ★
SCALABILITY	★	★ ★ ★	★ ★	★ ★ ★
PRIVACY	★	★ ★ ★	★ ★	★ ★
RESILIENCE	★	★ ★ ★	★ ★	★ ★ ★

★ poor, ★ ★ medium, ★ ★ ★ good

CASE STUDY: DESCRIPTION

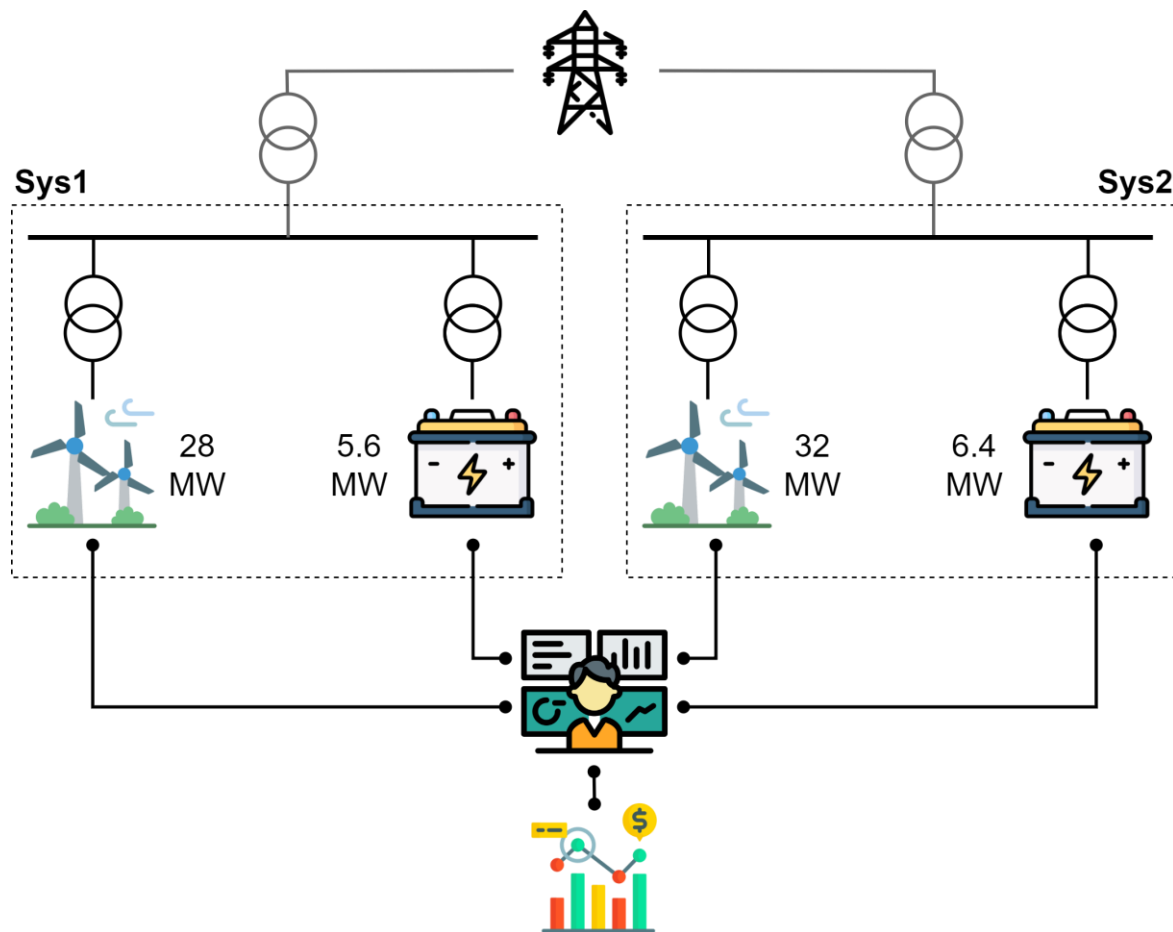

PROBLEM

Optimize the participation in the **day-ahead energy market** of a **wind-based commercial VPP** integrating **battery energy storage systems (BESSs)** as sources of flexibility.

SIMULATION SETTINGS

- 5 months period (January 2017 – May 2017).
- Historical day-ahead market prices in France.
- Wind power generation forecast provided by the French aggregator *Compagnie Nationale du Rhône*.

CASE STUDY: PROBLEM FORMULATION

We can distinguish between **global objectives/constraints** and **local objectives/constraints** in the optimization problem.

$$\operatorname{argmin}_z \sum_{t=0}^T \underbrace{[-\pi_E(t)E(t) + \pi^{E,\uparrow}(t) \Delta E^\uparrow(t) - \pi^{E,\downarrow}(t) \Delta E^\downarrow(t)]}_{\text{Market revenue}} + \underbrace{\sum_{i=1}^N \pi_i^D(t) (P_i^c(t) + P_i^d(t)) \Delta T}_{\text{BESSs degradation}},$$

subject to

$$E(t) - \Delta E^\uparrow(t) + \Delta E^\downarrow(t) = \sum_{i=1}^N [\hat{P}_i^W(t) - P_i^c(t) + P_i^d(t)], \quad \left. \vphantom{\sum_{i=1}^N} \right\} \text{Balancing constraint}$$

- *Market constraints,*
- *Technical constraints,*
- *BESS dynamics.*

CASE STUDY: PROBLEM DECOMPOSITION

The original problem is decomposed in three sub-problems: **market interaction**, **sys1/sys2 energy management**.

We consider *Analytical Target Cascading (ATC)* and *Alternating Direction Method of Multipliers (ADMM)* for **hierarchical optimization** and *Auxiliary Problem Principle (APP)* for **distributed optimization**.

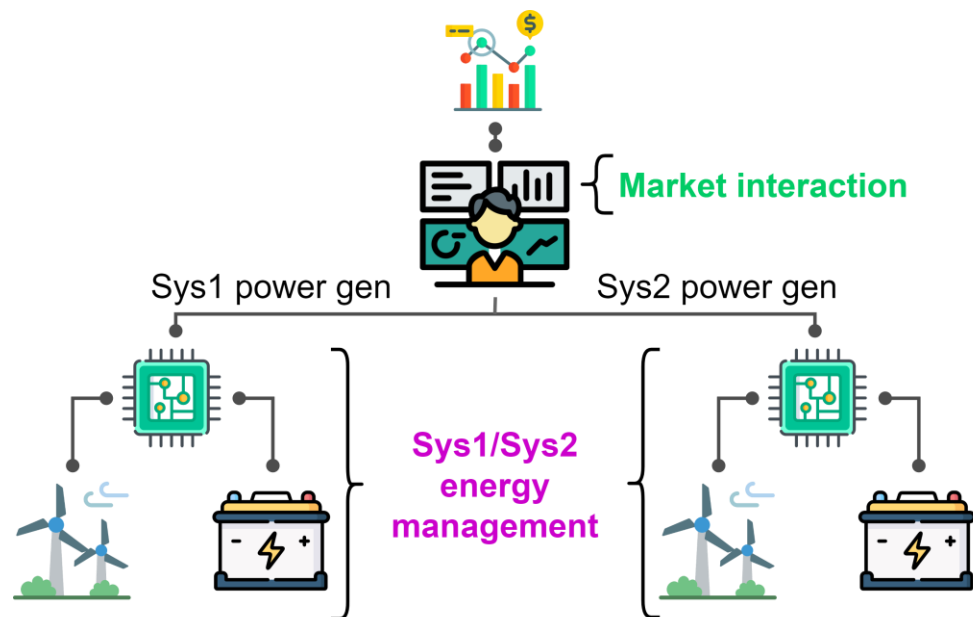

(I) *Hierarchical.*

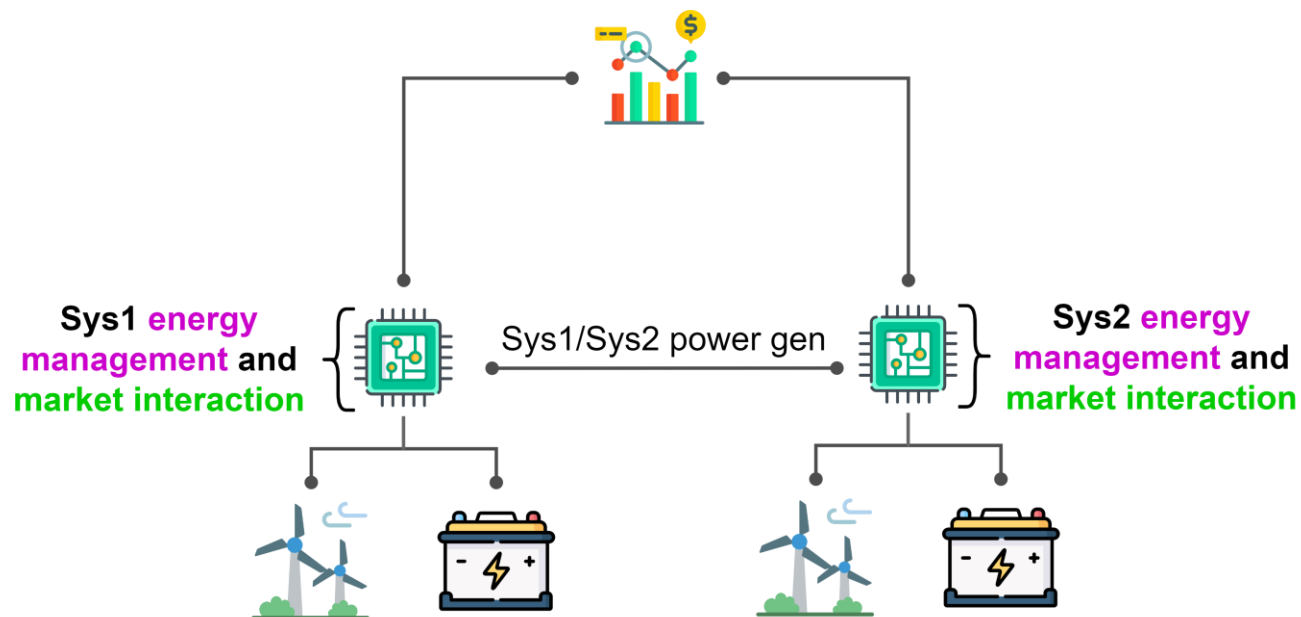

(II) *Distributed.*

RESULTS: COMPARISON

- **OPTIMALITY:** Centralized optimization (CO) increases by 28% the market revenue compared to decentralized approaches, with similar values of storage degradation. Hierarchical and distributed approaches converge to the optimal objective function value with less than 1% error.
- **SCALABILITY:** With parallelization hierarchical/distributed approaches can reduce computational effort, however CO is still faster when dealing with small-scale problems.

		Moderate accuracy ($\epsilon = 10^{-2}$)			High accuracy ($\epsilon = 10^{-4}$)		
	CO	ATC	ADMM	APP	ATC	ADMM	APP
<i>Obj. relative error [%]</i>	-	0.24	0.18	0.84	0.24	0	0.14
<i>No. of iterations</i>	-	11	6	25	11	14	30
<i>Time (sequential) [s]</i>	3	67	25	489	67	62	540
<i>Time (parallel) [s]</i>		38	21	425	38	50	495

RESULTS: PARAMETERS TUNING

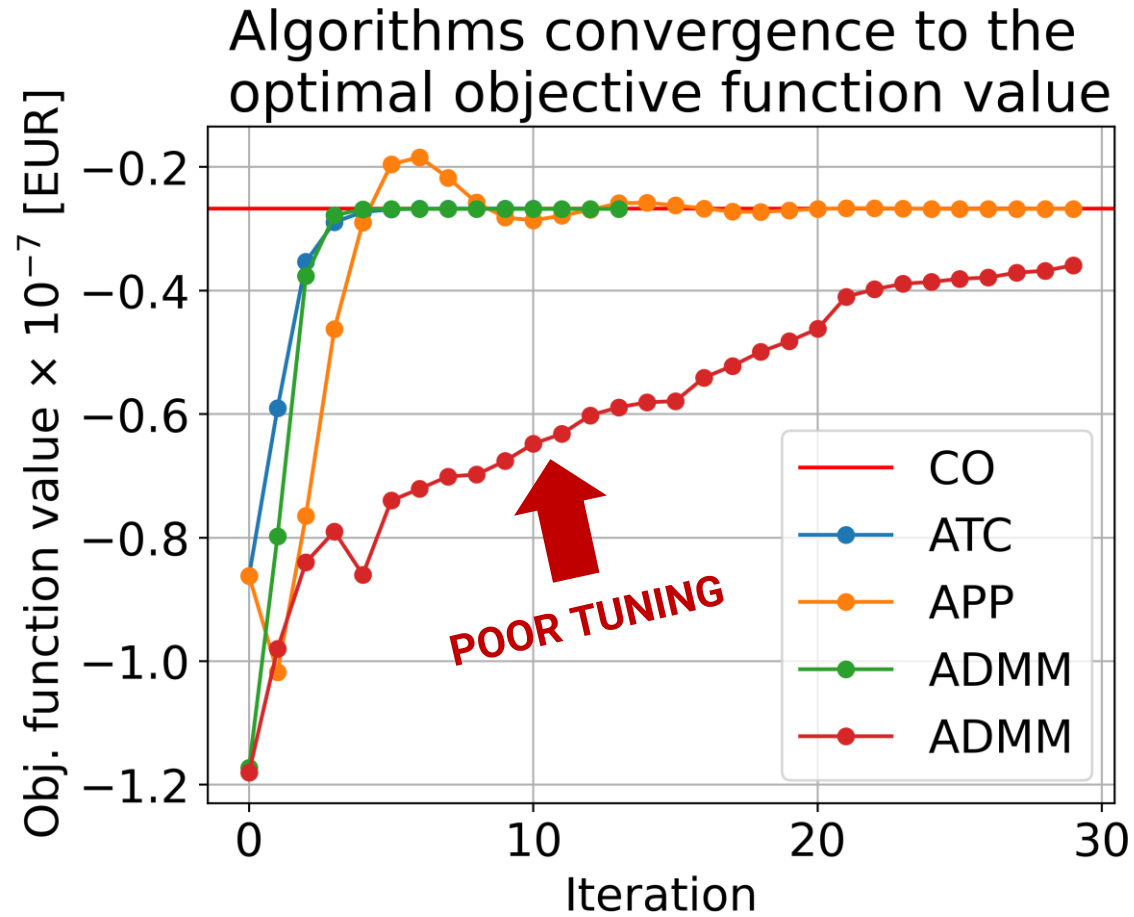

Due to convexity and strong duality of the problem under analysis, **the proposed decomposition coordination algorithms usually converge to the globally optimal solution.**

Their convergence strongly depends on the tuning of the algorithm parameters.

TAKEAWAY MESSAGES

1. COORDINATION

A **coordinated / centralized management** of the energy resources can **significantly enhance the profitability** of the VPP portfolio.

2. DECOMPOSITION

Hierarchical and distributed approaches can **enhance privacy, resilience and scalability** of the energy management strategy.

3. IMPLEMENTATION

Decomposition coordination algorithms usually **need additional effort to be implemented**, e.g., parameters tuning.

TAKEAWAY MESSAGES

1. COORDINATION

A coordinated / centralized management resources can enhance the the VPP portfolio.

2. DECOMPOSITION

Hierarchical and distributed management strategy.

3. IMPLEMENTATION

Decomposition coordination need be parameters tuning).

THINK CRITICALLY!