



HAL
open science

Wet to dry cycles for high temperature waste heat valorisation using a diphenylbiphenyl oxide mixture

Egoï Ortego, Léopold Védie

► **To cite this version:**

Egoï Ortego, Léopold Védie. Wet to dry cycles for high temperature waste heat valorisation using a diphenylbiphenyl oxide mixture. ORC2021 - 6th International Seminar on ORC Power Systems, Technical University of Munich, Oct 2021, Munich, Germany. hal-03514903

HAL Id: hal-03514903

<https://minesparis-psl.hal.science/hal-03514903>

Submitted on 6 Jan 2022

HAL is a multi-disciplinary open access archive for the deposit and dissemination of scientific research documents, whether they are published or not. The documents may come from teaching and research institutions in France or abroad, or from public or private research centers.

L'archive ouverte pluridisciplinaire **HAL**, est destinée au dépôt et à la diffusion de documents scientifiques de niveau recherche, publiés ou non, émanant des établissements d'enseignement et de recherche français ou étrangers, des laboratoires publics ou privés.

Wet to dry cycles for high temperature waste heat valorisation using a diphenyl-biphenyl oxide mixture

Egoi Ortego Sampedro*, Léopold Védie

* egoi.ortego@mines-paristech.fr
*Centre d'Efficacité Énergétique des Systèmes,
Mines ParisTech PSL,
5 rue Léon Blum, 91120 Palaiseau
France*

ABSTRACT

Waste heat recovery at temperatures ranging from 300°C to 400°C suffers from a lack of working fluids supporting well such high temperatures. Biphenyl-diphenyl oxide mixtures could be used as high temperature working fluids thanks to their good thermal stability up to 400°C. The paper explores the possibility of using a eutectic mixture known as Dowtherm A in a ‘wet to dry’ cycle for high temperature heat-to-power conversion. The paper presents first a Dowtherm A cycle alone for mechanical work and heat generation; the sensitivity of the cycle to the turbine inlet quality and to the hot source inlet temperature is analyzed. Then an ORC cascade is presented where the Dowtherm A is used in the topping cycle and toluene in the bottom cycle. The sensitivity to the hot source temperature and top cycle boiling temperature are presented. The simulations show that the mechanical power output can be increased compared to a standard cycle thanks to a better matching between the hot source and working fluid temperatures. Besides, the analysis shows that the value of the expansion inlet vapor quality leading to the maximal power output depends on the hot source temperature.

1 INTRODUCTION

The current ecological context underlines more than urgently the need to develop and improve technologies to produce electricity in a carbon-free way. With this in mind, the idea of exploiting industrial wasted heat deposits using organic Rankine cycles (ORC) to produce electricity seems a promising idea. However, at high temperatures, over 300°C, the working fluids usually considered, deteriorate relatively quickly as can be read in a thermal stability study made on three popular high temperature fluids (toluene, n-Pentane and cyclopentane) (Invernizzi, et al., 2017). There is no clear unanimity on degradation speeds and recommended operating temperatures however (Matthias, et al., 2020) mentioned a deterioration of 3.5% per year for toluene used at 300°C and a loss of 50% of the fluid after 3.3 years if used at a working temperature of 315°C. To cope with this problem (Matthias, et al., 2020) used air recirculation by mixing of part of the air coming out from the toluene boiler with the hot air source in order to reduce the temperature arriving into the boiler. This led to a turbine inlet maximum temperature of 255°C for a toluene based cycle.

In order to attain higher operating temperatures, working fluids such as DowTherm A can be used i.e. mixtures of diphenyl and diphenyl oxide. Specifically, DowTherm A is an eutectic mixture of 26,5% diphenyl and 73,5% diphenyl oxide; this mixture is normally used as a heat transfer fluid in liquid state for thermodynamic solar plants for example. The main advantage of this mixture is its thermal stability up to 400°C and a relatively low operating pressure (10.6bar at 400°C); that makes it a very good candidate to be a high temperature working fluid.

However, this fluid is subject to oxidation by air as was suspected in an early high temperature ORC investigation program conducted in the ‘60s (R.E.Niggemann, 1969); this aspect is clearly mentioned in the current Dowtherm A datasheet. This behavior requires avoiding air intakes in the system by ensuring the operation at pressures above one atmosphere. In these conditions, a condensation

temperature higher or equal to 257.1°C is required which may not seem optimal to maximize the energy extracted by the cycle. The second drawback of this fluid is that it is a dry fluid with a low dew curve slope leading to very high superheat values at the turbine's outlet; this requires a relatively big regenerator (of power approximately equal to 50% of the boiler power) which penalizes the system cost and recovery rate on the hot source stream.

A “wet to dry” (WD) Dowtherm A (DA) cycle in a cascade is a promising architecture in these conditions and was never studied before at the best knowledge of the authors. A WD cycle is close to a trilateral flash cycle (TFC), the main difference comes from the possibility in a WD cycle to set the turbine inlet vapor quality to a value ranging from 0 to 1. Another difference is the dry expansion outlet constrain (whereas trilateral term is used for a cycle in which the turbine outlet state is not defined but often biphasic).

The main interest of WD or TFC cycles compared to a Rankine cycle is that they allow better matching between source and working fluids temperature profiles and thus could lead to higher mechanical power rates. In WD cycles, the two-phase part of the expansion could be done in a two-phase stator or nozzle to generate a high-speed dry flow, and the last part of expansion could be done by an impulse turbine in dry conditions. The objective of this is to make the rotating parts operate in dry conditions in order to increase the efficiency compared to the other two-phase expander technologies. This concept is mentioned in (Eliot, 1982) for example and a recent paper presents it as a promising concept to increase power rates in ORC systems (White, 2021).

In a standard solar thermodynamic electricity production system or in indirect ORC systems, it is usual to use an intermediate heat transport oil loop. Dowtherm A (DA) is a heat transfer fluid very close to oils in its liquid state. The proposed system replaces the heat transfer loop by a loop including a two phase turbine. This change would require changing the boiler by an evapo-condenser and changing the pump. In such a situation, the additional cost associated with the WD cycle would be mainly related to the additional turbine and the pump changing costs. The proposed system is presented in Figure 1; it shows the WD DA cycle coupled to an ORC.

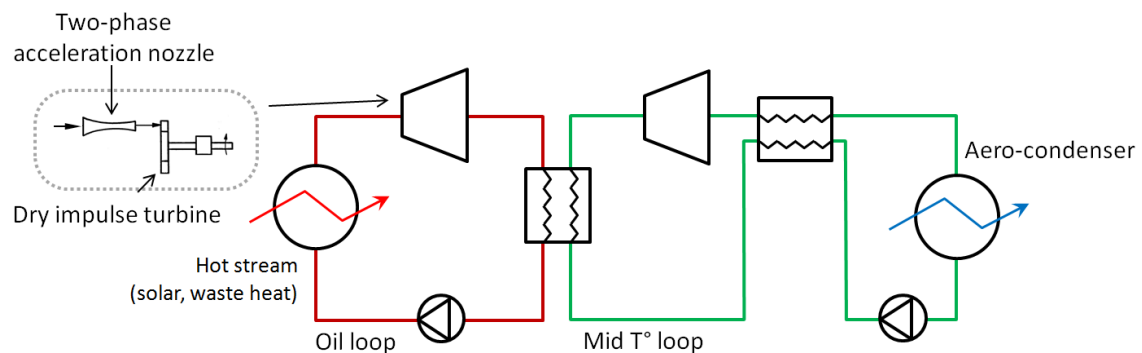

Figure 1: WD cycle in ORC a cascade

In this paper, first the WD cycle alone is simulated in order to highlight its sensitivity to various parameters, especially the turbine inlet vapor quality. Then the cascade is modeled in order to analyze the coupling between both stages. The low temperature stage is a simple ORC cycle using toluene that has been used or studied by various authors for high temperature ORC systems (Matthias, et al., 2020) (Song & Gu, 2015) (D.Casartelli, et al., 2015).

2 METHODS AND EQUATIONS

This section presents how the proposed system was explored. First, the fluid properties estimation method is presented, and then equations, specific constraints, and solving methods are presented for the two situations treated by the paper.

2.1 Equations of state

The Dowtherm A (DA) properties were modeled thanks to tabulated data obtained from Dow company open data sheet. For information, the critical temperature and pressure are 497°C and 31bar respectively. The data sheet includes also basic information on the thermal stability of DA such as its maximum stability temperature of 400°C and its auto-ignition temperature of 599°C. Besides, the fluid is described as oxidizable in air at high temperatures and as non-corrosive to metals. Most importantly, this data sheet contains tables of thermodynamic and transport properties of DA for dew and bulb lines. These tables contain temperature, pressure, liquid and vapour specific heat capacities, enthalpies, and densities. In addition, the data sheet contains a pressure-enthalpy diagram including several isothermal and isentropic curves. This was especially useful for superheated gas properties calculations. The diagram is presented in Figure 2. Using the free graphic analysis software Web Plot Digitizer, two data sets could be extracted: the first containing 177 triplets containing the pressure, enthalpy, and entropy (h, P, s), the second contains 104 triplets for the pressure, enthalpy, and temperature (h, P, T).

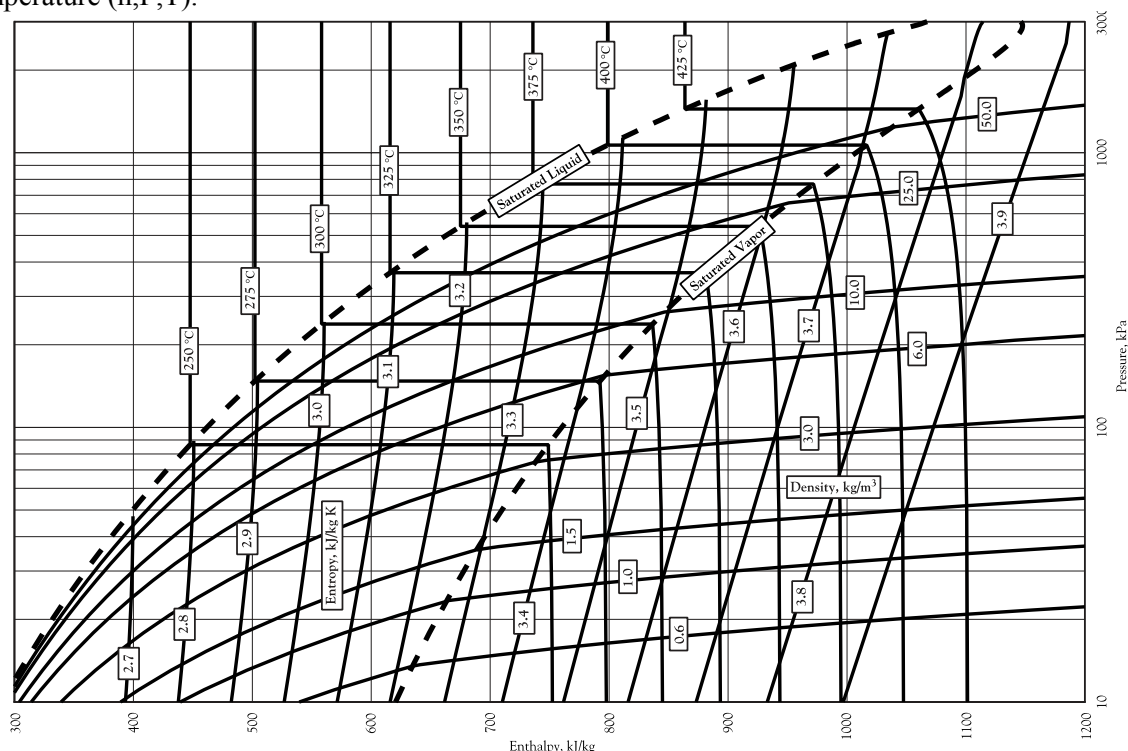

Figure 2: Graph of the Dowtherm A properties

The tabulated data used in sub-cooled, two-phase and superheated states and were used to compute the following state functions: $T = f(P, h)$, $S = f(P, h)$, $h = f(P, T)$, $h = f(P, S)$ and liquid and vapor saturated properties. Saturation states were computed by linear interpolations; other properties with bilinear interpolations. In sub-cooled liquid region, the effect of pressure on enthalpy was neglected. The fluids tested for the second stage were chosen from Coolprop data base (Bell, et al., 2014).

2.2 Cycles description and modeling

This section describes the two cycles studied in this article. Constraints and analyses made on both cases being different are presented in two sections. The first presents a WD cycle alone for electricity and heat production. The second case deals with a WD in a cascade for electricity production.

2.2.1 Dowtherm A cycle alone: this is a WD cycle with a regenerator. Figure 3 shows the system components and reference points.

The condensing temperature is defined in function of a given condenser pressure ($T_{Dc} = T(\text{sat}, P_{Dc})$).

Enthalpy gain in pump is computed by the pressure difference it operates and its efficiency (η_p); this is used to compute the pumping power.

$$\dot{W}_{Dp} = \dot{m}_D dh_p = \dot{m}_D \frac{(P_{Db} - P_{Dc})}{\rho_{D4}} \frac{1}{\eta_p} \quad 12$$

$$h_{D5} = h_{D4} + dh_p \quad 13$$

Assuming small variation of Cp through the pump:

$$T_{D5} = T_{D4} + \frac{dh_p}{Cp_{D4}} \quad 14$$

The net output power is:

$$\dot{W}_{net} = \dot{W}_{Dt} - \dot{W}_{Dp} \quad 15$$

The study conducted here aims to explore the effects of different parameters on the cycle net output power. The approach adopted here is fixing the hot source flow rate and then determining the working fluid flow rate by an iterative process.

The last is based on the **respect of the pinch condition** in the boiler between air and Dowtherm A. An optimizer is used from the open source R software (R-Core-Team, s.d.) to find the value of \dot{m}_D that minimizes the residual pinch function defined as follows:

$$\text{res} = |\min(T_{A2} - T_{D7}; T_{A3} - T_{D6}) - \text{Pinch}_{AD}| \quad 16$$

The initial value of \dot{m}_D was set to low values (0.01 kg/s) to improve convergence.

The systems design variables are the following:

- Boiler temperature T_{Db} : fixed here to its maximum allowable temperature i.e. 400°C. This fixes the boiler pressure to 10.6bar.
- Condenser pressure P_{Dc} : fixed here to its minimum recommended pressure i.e. 1.01bar. This fixes the condenser temperature to 257°C.
- Condenser outlet degree of sub-cooling SC_{D4} : fixed here to 3K.
- Turbine inlet quality x_{D1} : a sensitivity analysis is conducted on it and presented in section 3.1.

The pinch points' temperature differences are considered as component constraints and fixed to the values given in Table 1. Turbine and pump efficiencies are assumed to be equal to 0.7 and 0.5 respectively.

Table 1 gives the constraints, fixed parameters, unknowns and sensitivity variables for the DA alone case.

Table 1: parameters for the DA alone cycle analysis

Fixed parameters	Sensitivity variables	Constraints	Unknowns
$\dot{m}_A = 1\text{kg/s}$ $T_{Db} = 400^\circ\text{C}$ $P_{Dc} = 1\text{bar}$ $SC_{D4} = 3\text{K}$	$440^\circ\text{C} < T_{A1} < 500^\circ\text{C}$ $0 < x_{D1} < 1$	$\text{Pinch}_{AD} = 30\text{K}$ $\text{Pinch}_r = 10\text{K}$	\dot{W}_{net} \dot{m}_D : iterated

For a given set of variables, the solving method consists in computing the states of the points 1, 2, 4, 5, 3, 6, 7, and finally A2 and A3 (points in Figure 3 and Figure 4). This is done in a sub-routine included in the iterative process used to define the working fluid mass flow rate.

2.2.2. Cascade cycle: This section presents the cascade composed of an upper DA WD cycle and a bottom Rankine cycle. Figure 5 presents the components arrangement and Figure 6 presents an example of a T-S diagram where air, DA, and secondary fluid are represented.

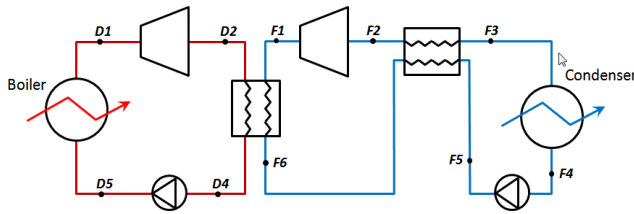

Figure 5: WD cycle + bottom cascade cycle

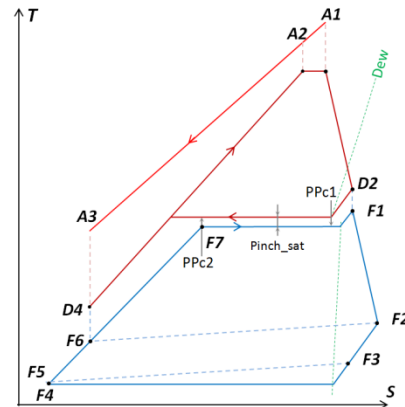

Figure 6: TS diagram for the WD cycle

The choice was done here to test a classical Rankine cycle for the bottom cycle (not a WD) following the idea that the DA system could in a first step be developed as a plug-in to the heat transfer loop of a classical ORC system. Therefore, air exchanges power **only** with the heat transfer fluid loop. This implies a potentially significant degree of sub-cooling at the DA condenser outlet. The sub-cooling of the DA condenser outlet is thus a parameter that can be changed in order to optimize the system.

Another difference with the DA alone cycle is the absence of a regenerator in the DA loop. However, a regenerator is used for the bottom cycle.

The bottom cycle parameters are the following:

- The turbine inlet state: the turbine can observe a superheated state at its inlet ($h_{F1} = h(P_{F1}, T_{Fb-sat} + Sh_{F1})$). A preliminary analysis showed that the best superheating was the lowest possible whatever the other parameters were; thus Sh_{F1} was set to a reasonable minimum equal to 1K.
- The boiler pressure is defined by its boiling temperature T_{Fb-sat} ; this is related to the DA condensing temperature by a predefined pinch (see $Pinch_{sat}$ in Figure 6). For the toluene this leads to a boiling temperature and pressure of 253°C and 17.2bar respectively; these conditions are compatible with the thermal constraints mentioned by (Matthias, et al., 2020) and coherent with the operating conditions of the cited article.
- The condensation temperature is set to 50°C. This defines the condensation pressure.

The DA top cycle parameters are the following:

- Turbine inlet quality (x_{D1}): it will no longer be considered as a design parameter to explore. Using an optimizer, the vapor quality that maximizes the global power output will be estimated for each case. The initial value for quality was set to 0.8 in the optimizer.
- Condenser sub-cooling degree (SC_{D4}): it appeared in a preliminary study that the best sub-cooling degree was the highest possible. Thus, SC_{D4} was defined equal to the secondary fluid regenerator cold stream outlet incremented by the pinch ($T_{D4} = T_{F2-6} + pinch_{D-F2}$).
- The evaporation temperature: this will be the object of a sensitivity analysis.

Turbines and pumps efficiencies were set to 0.7 and 0.5 respectively.

Please note that given the parameters fixed here, the only parameter changing in the bottom cycle is its mass flow rate. It depends on the power balance on the evapo-condenser. The evapo-condenser boiling and condensing temperatures could be optimized but since the DA condensing pressure is set to a reasonable minimum and the toluene evaporating temperature to a reasonably high value, the room for optimization seems to be small a priori. The choice was made here to maintain the DA condensation pressure at its lowest value.

The bottom cycle includes a regenerator for which the inlet/outlet conditions are defined using the same method than for the precedent regenerator. The power balance at the evapo-condenser is:

$$\dot{Q}_{e-c} = \dot{m}_D (h_{D2} - h_{D4}) = \dot{m}_F (h_{F1} - h_{D6}) \quad 17$$

From this balance, the mass flow rates ratio between DA and F is determined ($r_m = \dot{m}_F/\dot{m}_D$).

The DA boiler power balance is written:

$$\dot{Q}_b = \dot{m}_A C_{pA}(T_{A1} - T_{A3}) = \dot{m}_D (h_{D1} - h_{D5}) \quad 18$$

In order to check that pinch condition is respected in the evapo-condenser (check done for points F1, PPc1, PPc2 and F6, see Figure 6), intermediate power balances are operated for the points PPc1 and PPc2 in order to compute the temperature differences between the hot and cold streams. When the pinch condition is not respected in one of the control points, r_m is set to 0. The value of the allowed pinch point temperature difference is $Pinch_{sat}$.

Table 2 gives the fixed parameters, constraints, unknowns and sensitivity variables for the cascade case.

Table 2: parameters for the analysis of the cascade

Fixed parameters	Sensitivity variables	Constraints	Unknowns
$\dot{m}_A = 1kg/s$ $P_{DC} = 1bar$ $Sh_{F1} = 1K$ $P_{Fb} = 17.2bar$ $T_{Fc} = 50^\circ C$	$320^\circ C < T_{Db} < 400^\circ C$ $380^\circ C < T_{A1} < 500^\circ C$	$T_{D4} = T_{F2-6} + pinch_{D-F2}$ $Pinch_{AD} = 30K$ $Pinch_r = 10K$ $Pinch_{sat} = 5K$ $x_{D2\ min} = 1$	\dot{W}_{net} \dot{m}_D : obtained by iteration \dot{m}_F : obtained with \dot{m}_D x_{D1} : obtained by iteration to maximize \dot{W}_{net}

The process of solving the whole cascade was to first solve F cycle, then DA cycle, check the pinch condition at the evapo-condenser to finally compute the DA mass flow rate.

Hot source flow rate is fixed and r_m being explicit (for a given set of design parameters), the only variable subject to an iterative process is \dot{m}_D . A sensitivity analysis is conducted on T_{Db} and T_{A1} .

3 RESULTS

3.1 Dowtherm A cycle alone

This section presents a sensitivity analysis done on the DA WD cycle alone; hot source inlet temperature was changed from 440°C to 500°C and turbine inlet vapor quality from 0 to 1. The air mass flow rate was set to 1kg/s.

Figure 7 shows the output power as a function of x_{D1} for various values of T_{A1} . Firstly, it is observed that the power of the cycle increases with the temperature of the source. Secondly, for all values of T_{A1} , the maximal power inlet quality is lower than unit; this justifies the use of a wet-to-dry cycle. The DA flow rates are given in Figure 8; the general observation is that at low x_{D1} values the mass flow rate can be increased compared to the case at $x_{D1} = 1$; the variation is noticeable.

The value of the quality at maximum power point is a consequence of the compromise between the achievable mass flow rate and cycle efficiency. The last depends only on x_{D1} as shown by Figure 8 (for a given boiling temperature), and the first is defined by the pinch constraint.

Besides, there is a break in slope on the power and flow rate curves; this sharp change in power is more visible for low air inlet temperatures. This slope break corresponds to the maximal power in cases where the air temperature inlet is low; when temperature is high the slope break doesn't correspond to the maximum but it is nevertheless close to it. The dependence of the power to x_{D1} decreases when T_{A1} increases; this makes the maximum power less sensitive to small variations in turbine inlet vapour quality at high T_{A1} .

In general, a strong correlation between the flow rate and the power is observed for qualities between $x_{D1_{PuMax}}$ and one. However, the correlation is not linear because the cycle efficiency decreases when x_{D1} decreases as shown by Figure 9. That is why power increases at a lower rate than the flow rate does when decreasing x_{D1} . For qualities below $x_{D1_{PuMax}}$ and low values of T_{A1} , the mass flow rate is not increasing enough compared to the efficiency drop and thus the output power decreases. This is not true for high values of T_{A1} because efficiency at $x_{D1_{PuMax}}$ is still high.

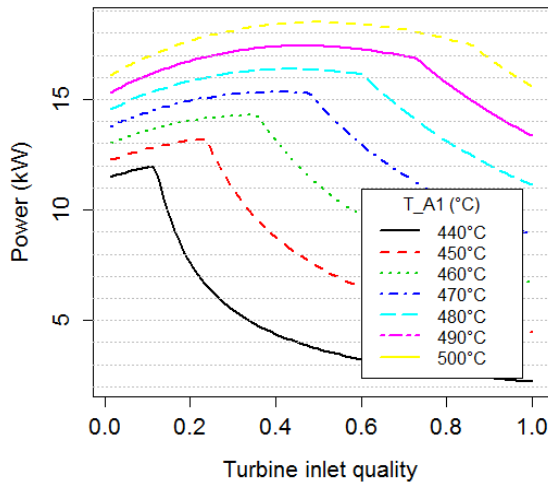

Figure 7: output power function of x_{D1} and T_{A1}

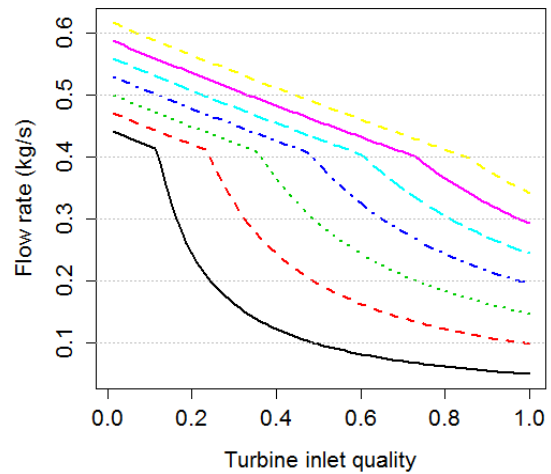

Figure 8: Dowtherm A flow rate function of x_{D1} and T_{A1}

Also it is noticeable that the break in the slopes corresponds exactly to the double pinch situation i.e. the case where the two possible pinch point's temperature differences ($A2$ and $A3$ points in Figure 4) are identical. This is clearly visible in Figure 10 where the pinch ratio ($(T_{A2} - T_{D7}) / (T_{A3} - T_{D6})$) and the power are plotted as a functions of x_{D1} . The unit pinch ratio corresponds to double pinch situation.

As a last comment, it could be said that the cycle is more sensitive to x_{D1} when the pinch point is on $A2$ (i.e. for $x_{D1} > x_{D1_{PuMax}}$) than when the pinch is on $A3$.

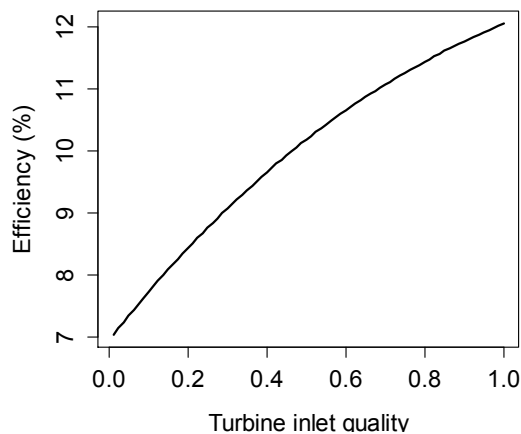

Figure 9: DA WD cycle efficiency

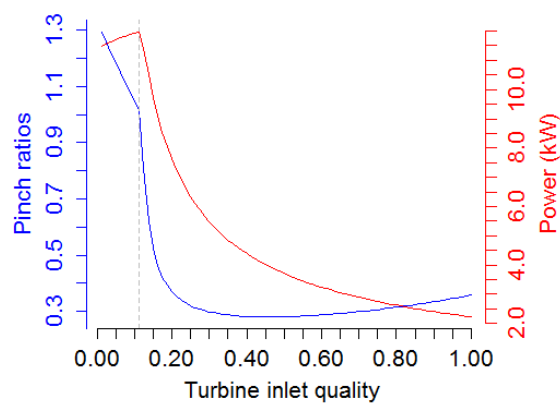

Figure 10: mechanical net power and pinches ratio; $T_{A1} = 440^{\circ}\text{C}$

3.2 Cascade

The simulation results of a cascade of a DA WD cycle and a toluene Rankine cycle are presented here.

The effect of DA boiler saturation temperature (T_{Db}) and hot air inlet temperature (T_{A1}) on cascade output power are explored here. The first ranges between 320°C and 400°C and the second between 380°C and 500°C .

As a reminder, in the computing procedure, the DA turbine inlet quality leading to the maximal power is computed for each test case; so the maximal power is directly given here. This is shown in Figure 11. The value of the turbine inlet quality leading to maximal output power is shown in Figure 12. The areas without any values correspond to T_{Db} temperatures higher than $T_{A1} - Pinch_{Da}$.

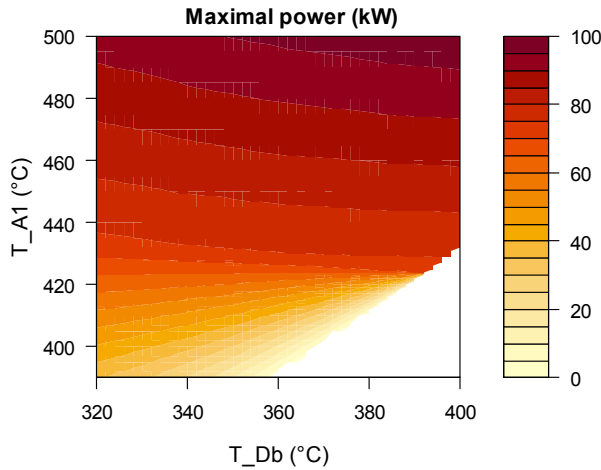

Figure 11: maximal power as function of T_{Db} and T_{A1}

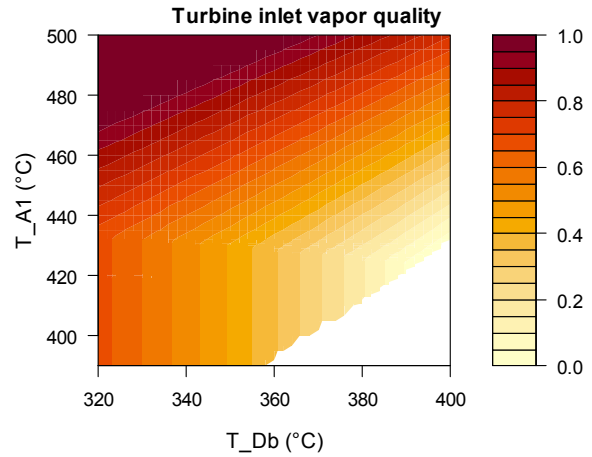

Figure 12: turbine inlet quality as function of T_{Db} and T_{A1}

Several observations can be made on the values of the maximum power (Figure 11). For T_{A1} above 430°C , the maximum power increases moderately with T_{Db} . For T_{A1} values below 420°C , the maximum power drops with T_{Db} . For T_{A1} values between 420 and 430°C , a transition between the two trends can be observed. Optimal quality value also seems to follow two different trends according to the values taken by T_{A1} (Figure 12). It decreases with T_{A1} up to the transition value of T_{A1} , below this, quality does not depend on T_{A1} . Also quality decreases when T_{Db} increases. Furthermore, for high values of T_{A1} and low values of T_{Db} , the optimal vapor quality saturates at 1, which suggests that a superheating of Dowtherm A would theoretically increase the output power of the cycle.

The transition between the two trends observed in the power and quality occurs when, at constant T_{Db} , the turbine inlet vapour quality can no longer decrease with decreasing T_{A1} because otherwise, the turbine outlet stream would be biphasic. This explains why at constant T_{Db} , below a value of T_{A1} , the optimal vapour quality takes on a fixed value. This is well illustrated by Figure 13 where the T-S diagrams were plotted for air, DA, and toluene for a DA boiling temperature of 340°C and various values of air inlet temperature. For information, the reference entropy scale was the one of toluene.

This figure shows how x_{D1} decreases when T_{A1} decreases and how at temperatures lower than 430°C , inlet quality stagnates at a given value for which turbine outlet arrives on dew-line.

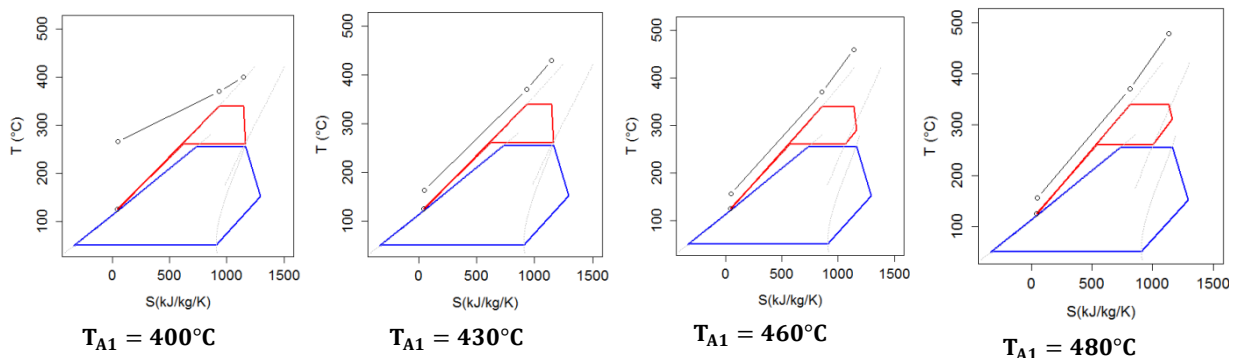

Figure 13: T-S diagram for air-DA and Toluene at $T_{Db} = 340^{\circ}\text{C}$

The presented cascade cycle can be compared as an example to the cascade studied by (Matthias, et al., 2020). The last presented a theoretical output power of 72kW for 0.9kg/s at 492°C inlet air temperature (before dilution), so around 80kW per kg/s of air. At the same air temperature, the presented cycle presents 96kW maximal power (+20%). However, a unique example isn't sufficient to demonstrate the techno-economic benefit of the presented cascade and further comparisons should be done to other cycles.

4 CONCLUSIONS

The paper presented a wet-to-dry Dowtherm A cycle that could help in increasing the recovery rate of high temperature waste heat ORC systems. The main advantage of such a cycle is the better matching between the working fluid and hot source stream temperature profiles and the possibility of integrating the system at a moderate supplementary cost since it could be added in the transport loop for industrial heat recovery or concentrated solar power generation systems where the heat exchangers would already be present.

The results for the DA alone cycle show that the maximum power is obtained for a two-phase turbine inlet situation; this justifies the implementation of a wet-to-dry cycle. This section showed also that an optimal inlet quality exists that maximizes the output power.

Regarding the cascade, the sensitivities of the optimal vapour quality and maximum power to air inlet temperature and DA boiling temperature were presented. In general, the lower the inlet air temperature the lower the optimal DA turbine inlet quality. This trend is limited by the DA turbine outlet dry condition that defines the minimal inlet quality for low air inlet temperatures.

The presented preliminary analysis should be completed by a techno-economic assessment including the evaluation of other fluids for the bottom cycle.

NOMENCLATURE

Roman characters		Subscripts	
C_p : specific heat (J/kg/K)	s : entropy (J/kg/K)	A: air	F: bottom cycle fluid
h : enthalpy (J/kg)	T : temperature (K)	b: boiler	p: pump
\dot{m} : mass flow rate (kg/s)	\dot{W} : mechanical power (W)	c: condenser	r: regenerator
\dot{Q} : heat flow (W)	x : vapor quality (-)	D: Dowtherm A	SC: sub-cooling
			t: turbine

REFERENCES

- Bell, I. H., Wronski, J., Quoilin, S. & Lemort, V., 2014. Pure and Pseudo-pure Fluid Thermophysical Property Evaluation and the Open-Source Thermophysical Property Library CoolProp. *Industrial & Engineering Chemistry Research*, Volume 53, p. 2498–2508.
- Eliot, D. G., 1982. *Theory and Tests of Two-Phase Turbines*. Pasadena: Jet Propulsion Laboratory.
- Invernizzi, C. M., Iora, P., Manzolini, G. & Lasala, S., 2017. Thermal stability of n-pentane, cyclopentane and toluene as working fluids in organic Rankine engines. *Applied Thermal Engineering*.
- Matthias, L. et al., 2020. Experimental investigation of a cascaded organic Rankine cycle plant for the utilization of waste heat at high and low temperature levels. *Energy Conversion and Management*.
- R.E.Niggemann, 1969. *Quarterly progress report N°12. Organic Rankine Cycle Technology Program*, s.l.: Aviation Division Sundstrand Corporation.
- R-Core-Team, n.d. *R: A language and environment for statistical computing*. [Online] Available at: <https://www.R-project.org/> [Accessed 2020].
- White, M. T., 2021. Cycle and turbine optimisation for an ORC operating with two-phase expansion. *Applied Thermal Engineering*.