



**HAL**  
open science

## PNAPI Digital Support Platform for Beekeepers

Yassine Kriouile, Lamine Bougueroua, Corinne Ancourt, Katarzyna Wegrzyn-Wolska, Jean-Charles Huet

► **To cite this version:**

Yassine Kriouile, Lamine Bougueroua, Corinne Ancourt, Katarzyna Wegrzyn-Wolska, Jean-Charles Huet. PNAPI Digital Support Platform for Beekeepers. Artificial Intelligence & Industrial Applications (A2IA'2020), Dec 2020, Meknes, Morocco. hal-03105211

**HAL Id: hal-03105211**

**<https://minesparis-psl.hal.science/hal-03105211>**

Submitted on 10 Jan 2021

**HAL** is a multi-disciplinary open access archive for the deposit and dissemination of scientific research documents, whether they are published or not. The documents may come from teaching and research institutions in France or abroad, or from public or private research centers.

L'archive ouverte pluridisciplinaire **HAL**, est destinée au dépôt et à la diffusion de documents scientifiques de niveau recherche, publiés ou non, émanant des établissements d'enseignement et de recherche français ou étrangers, des laboratoires publics ou privés.



## Introduction

Bees are suffering from a big problem; the high rate of mortality. This is mainly caused by climate change, intensive farming, pesticides use and varroa parasites.

Consequences:

- Decrease of quantity of bees' products like honey
- Diminution of pollination considered as a primordial step in agriculture

Scientific work has allowed establishing concrete elements to guide the decisions of beekeepers. But this knowledge is not well transferred to them and does not consider their different needs.

Our approach: a large computer system based on artificial intelligence. It would collect information, build and improve beekeeping knowledge, and help beekeepers in decisions making

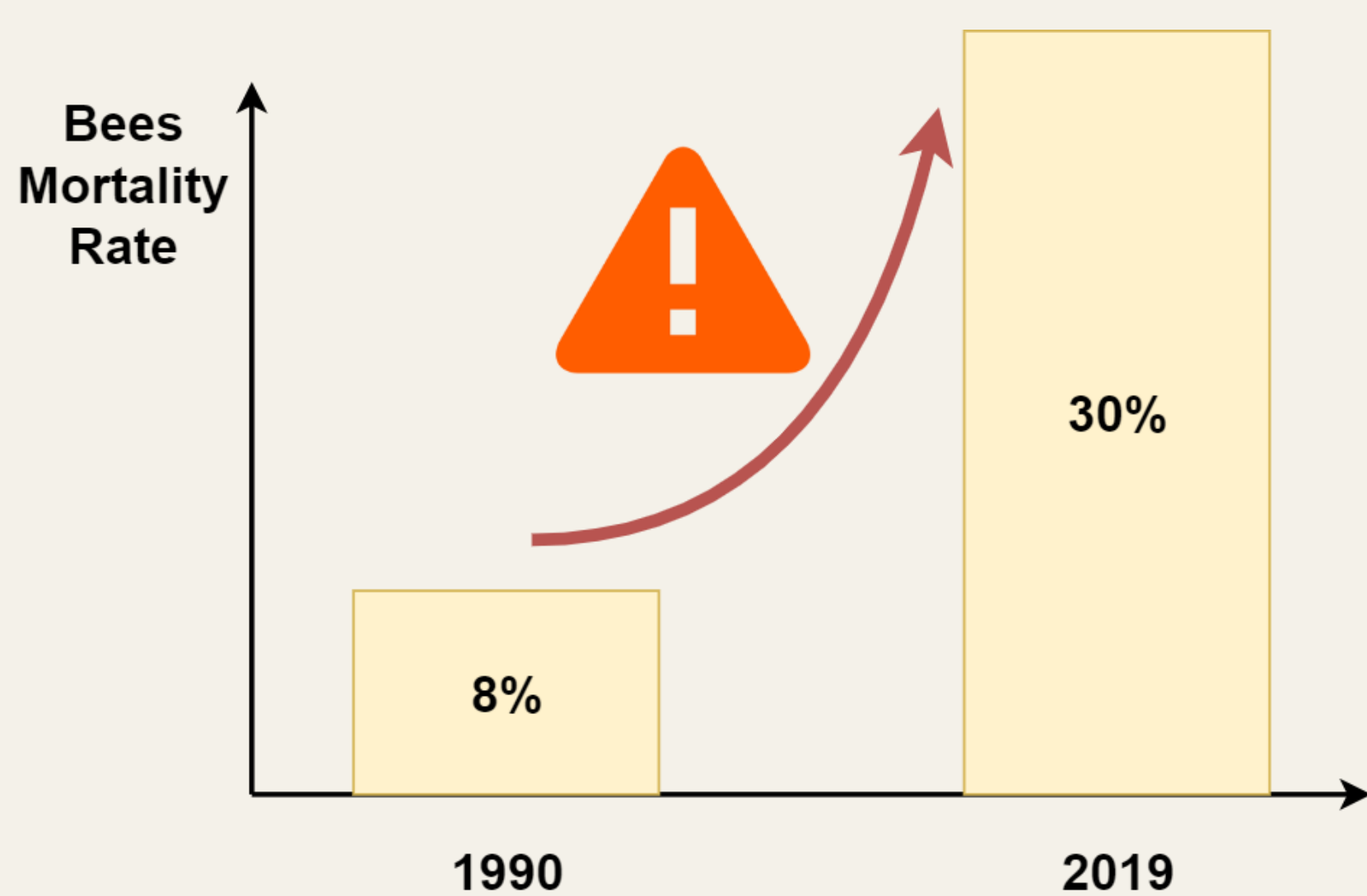

Figure 1: Increase of bees' mortality rate

## Context

ITSAP (Technical and Scientific Institute of Beekeeping and Pollination) proposes the project PNAPI.

Funder: The French Ministry of Agriculture and Food financing actions within the agricultural and rural development program

Duration: 42 months started on January 2019

Technical and research partner: EFREI (Engineering School of Digital Technologies)

Research laboratory: ALLIANSTIC

The project will be realized in collaboration with other partners specialized in beekeeping industries.

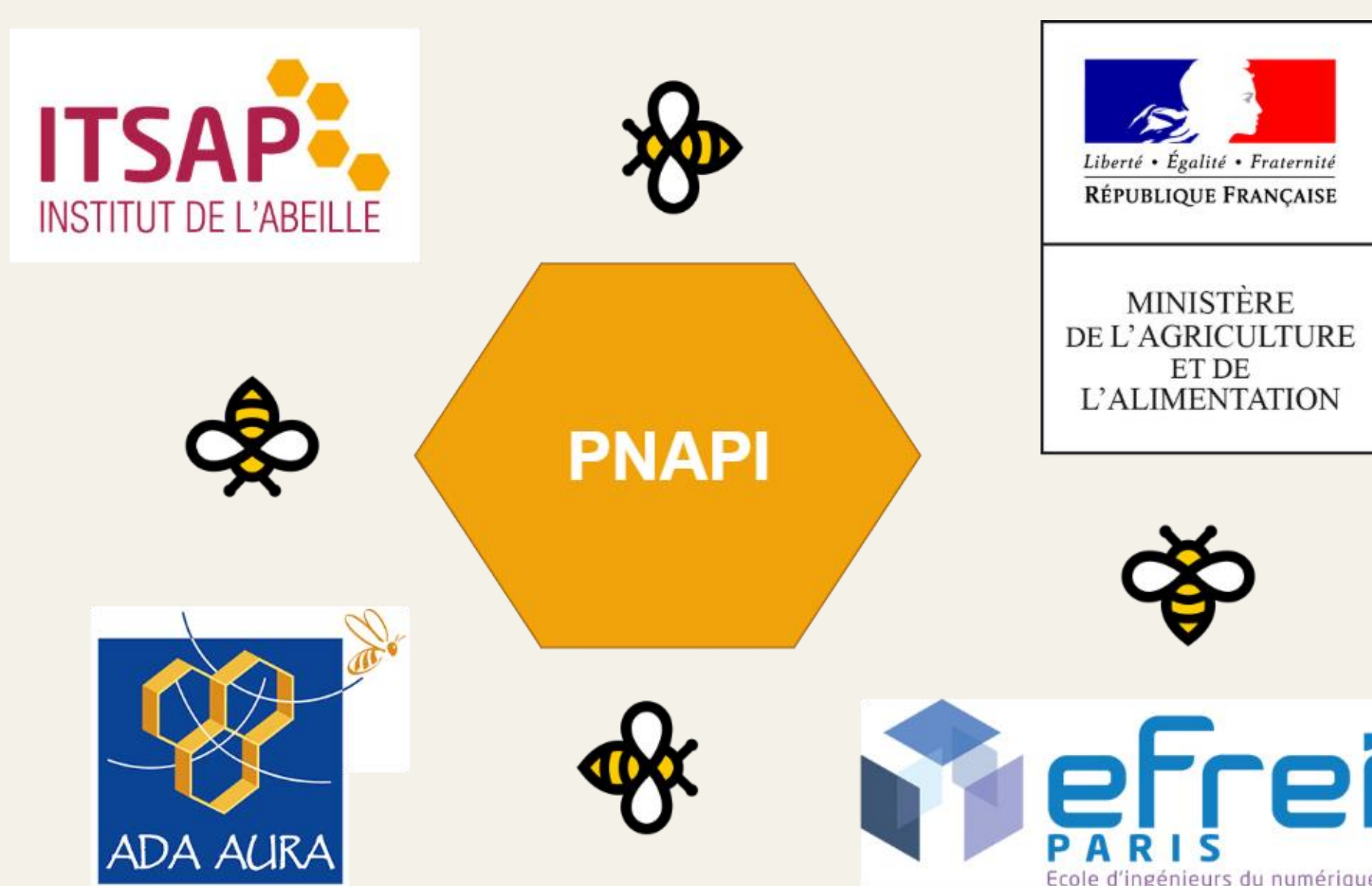

Figure 2: PNAPI project partners

## Two Layered Structure

This system would manage two kinds of data:

- **Information:** facts and events happening in the domain of bees and beekeeping
- **Knowledge:** rules and principles related to the domain of bees and beekeeping ("If the beehive has more than 3% varroa infestation, the hive should be treated")

**Information :**

- **Local Information** concerns points with specific coordinates; beekeeper scope (colony health, temperature, humidity, weight...)
- **Global Information:** statistics summarizing local information; beekeeping organization scope (regional distribution of predatory Asian hornets, weather forecast...)

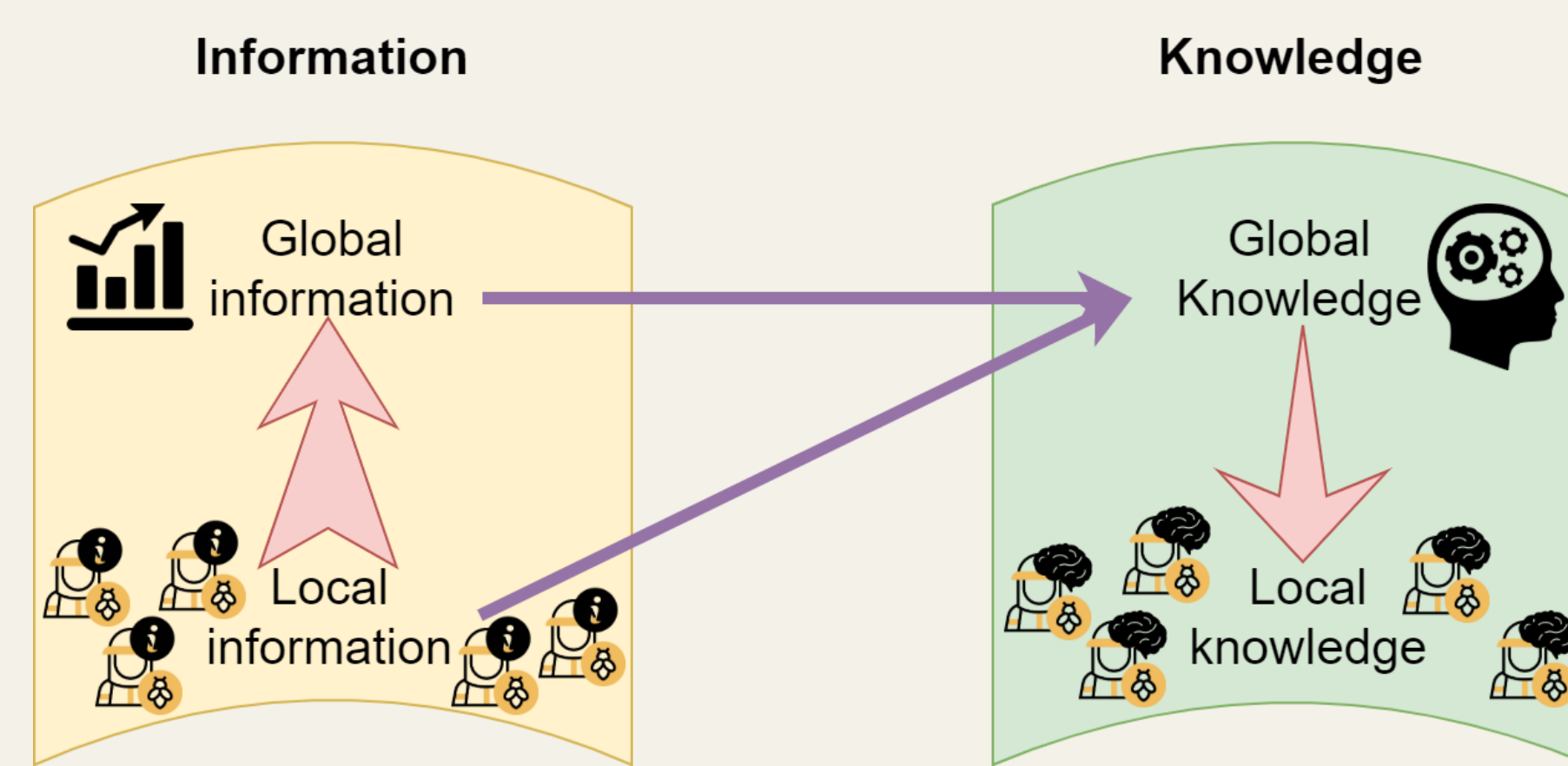

Figure 3: Kinds of data managed by the system

**Knowledge:**

Knowledge can be materialized by deep neural networks and high semantic models. It is created and refined by the system using collected information.

Locally, beekeepers have slightly different needs and objectives (pollination service, production of honey, production of royal jelly...), so each one has its own personal knowledge based on the global one.

## Interacting Elements

Elements interacting with the system:

- Managing tools for Beekeepers: collecting information and managing apiaries and hives
- Existing systems: environment systems providing weather data
- Organizations: state institutions or associations sending alerts
- Experts: sending information about best practices and guidelines
- Social Web: tweets concerning beekeeping
- Audio: recording of bees' sounds
- Image: images of bees' colonies

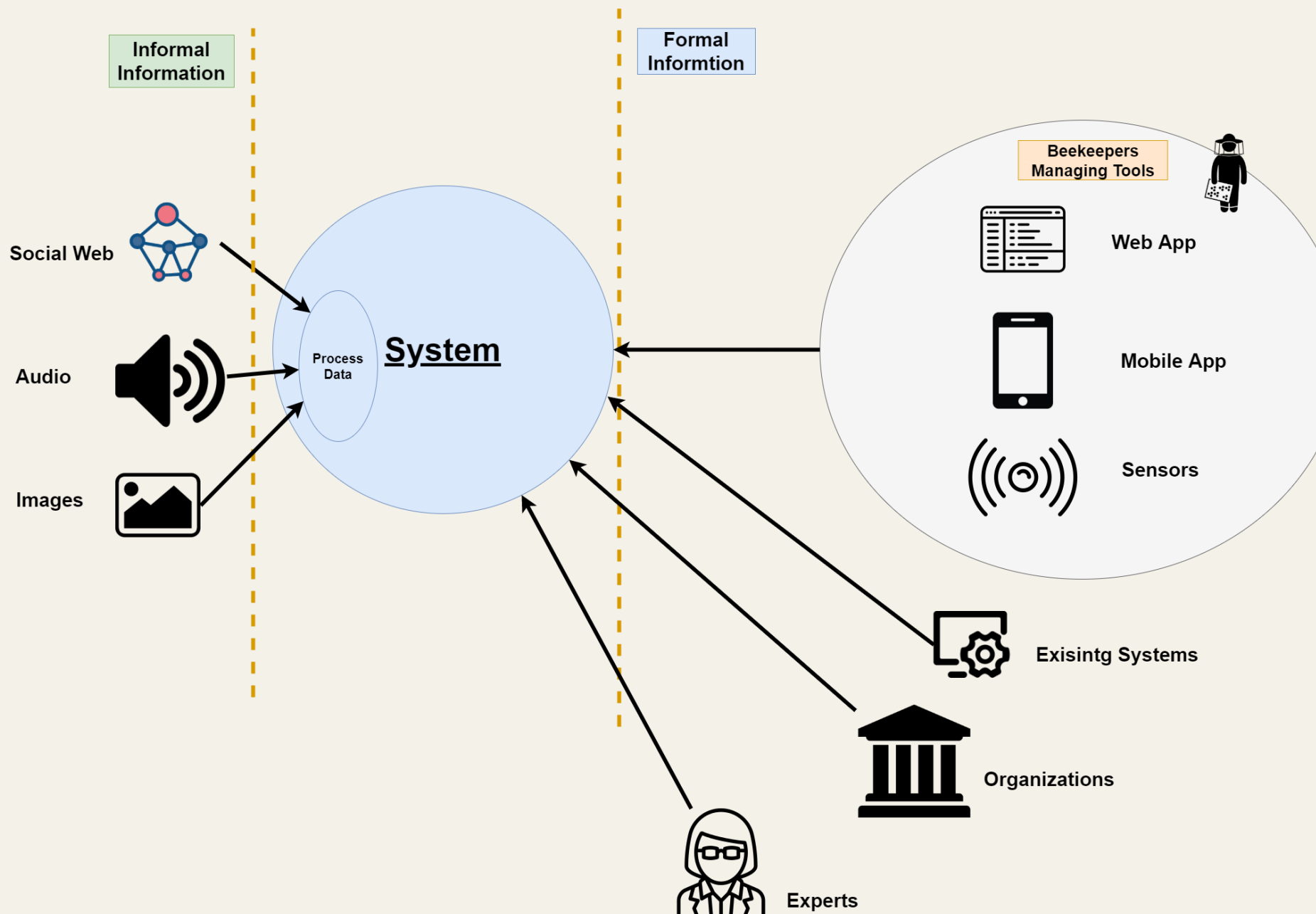

Figure 4: Elements interacting with the system

The system would implement mechanisms for handling heterogenous and multi-source data.

## Artificial Intelligence

The system exchanges knowledge with experts:

- Rules given by experts and used for extending the knowledge
- Predictions based on current situations
- Understanding: knowledge provided to experts in a normalized format

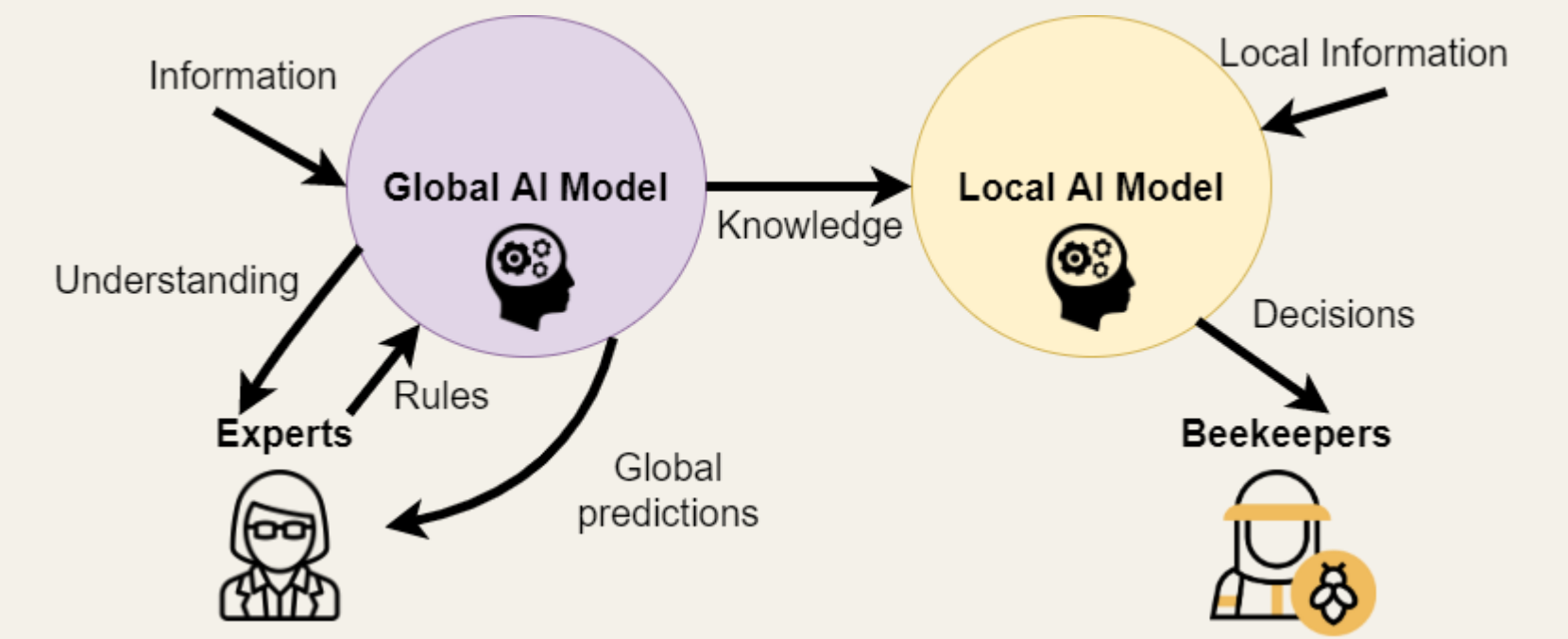

Figure 5: Artificial Intelligence Structure

The local model is based on the global model, which is refined according to the beekeeper's specific context in order to help him make decisions that meet his objectives (treat colony, move hive, check bees' health status...).

We will first focus our work on the system agent responsible for processing images.

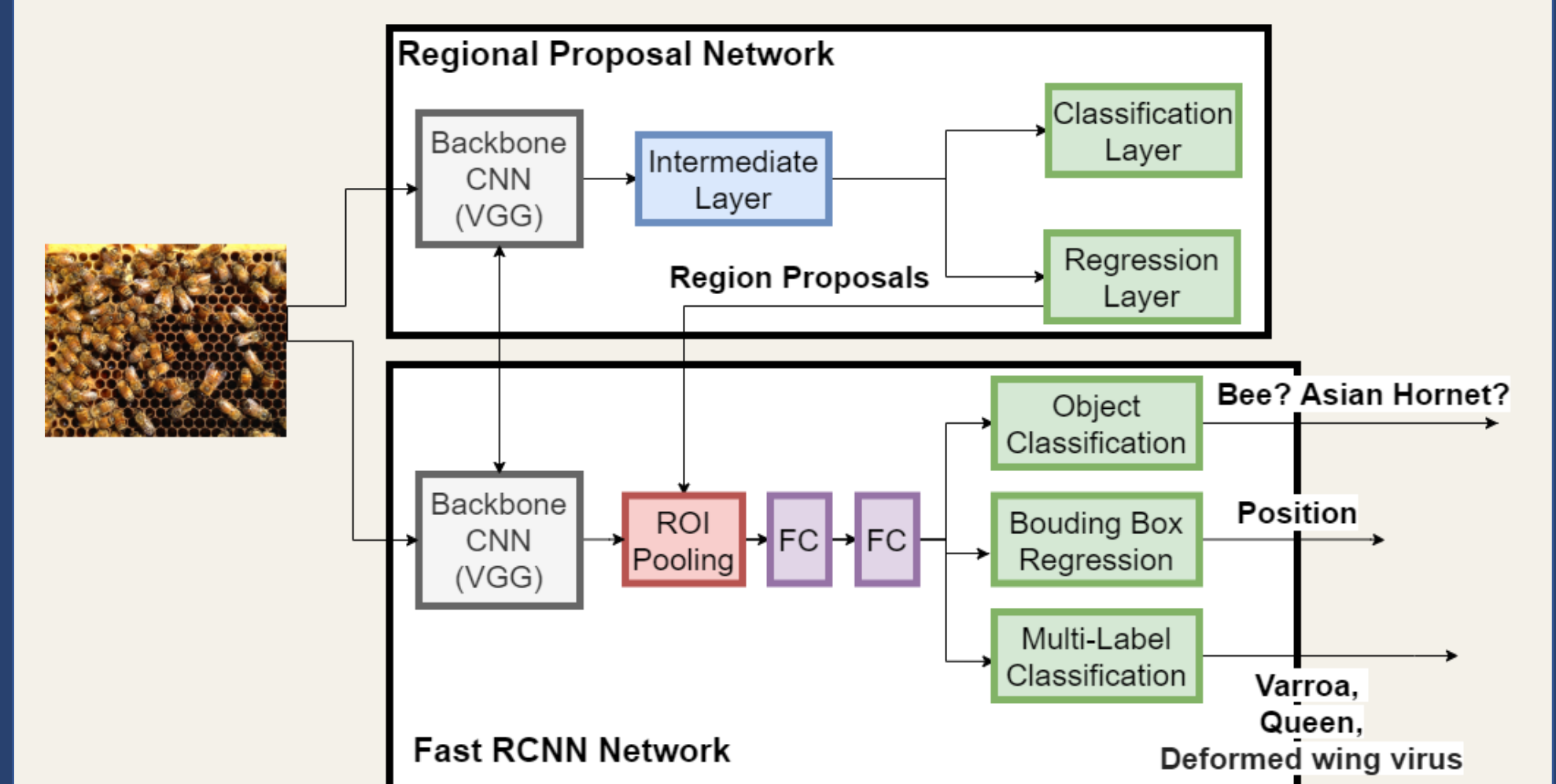

Figure 6: Neural Network Architecture for processing bees' images

## Challenges & Breakthroughs

**Challenges**

- Scalability
- Big and heterogenous data analysis
- Noisy environment
- Constraints of beekeeping domain
- Image processing: disease recognition,...
- Voice processing: beekeeper speech recognition,...

**Breakthroughs**

- Definition of a beekeeper ontology
- A flexible decision-making system adapted to global and local environments
- Hybrid artificial intelligence

## Conclusion & Perspectives

We believe that the already started implementation of this architecture in collaboration with 415 beekeepers will lead to developing a global and flexible system which would allow beekeeping community to share relevant information and knowledge, and take appropriate decisions.

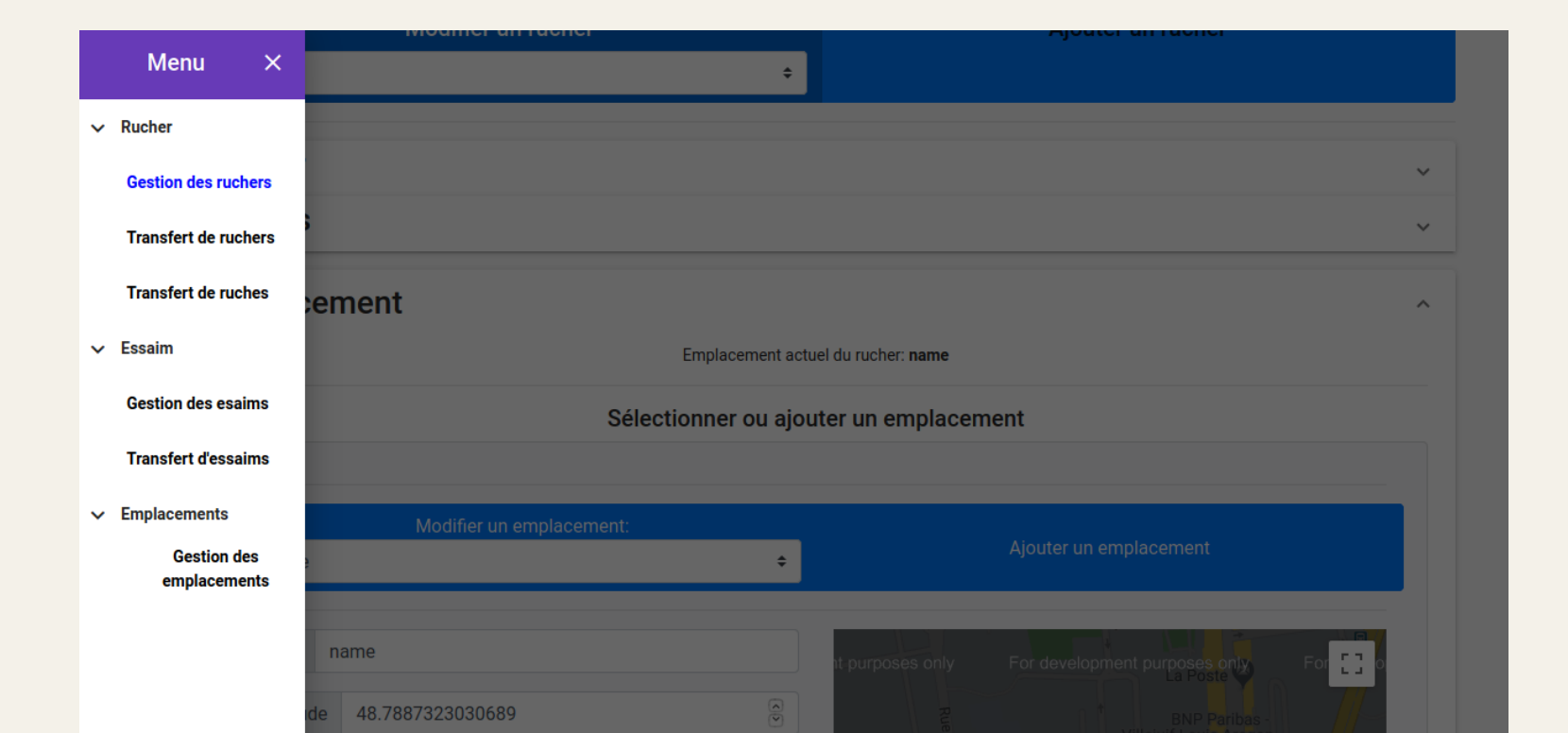

Figure 6: Web interface - development in progress

We hope that our future collective intelligence system would participate in the prevention of bee's deterioration. In long term we will try to extend the field of use of the system to the European level.

## Acknowledgements

Special thanks to the ministry of agriculture and food which is financing PNAPI through CASDAR (the special appropriation account "Agriculture and Rural Development") under the project number 18ART1831.

## Related works

- Zine Eddine Latioui, Lamine Bougueroua, Alain Moretto. "Social Media Chatbot System – Beekeeping Case Study". Conference HIS 2019.
- Nikola Zogović, Mića Mladenović, Slađan Rašić. "From Primitive to Cyber-Physical Beekeeping". Conference ICIST 2017.
- Olivier Debauche, Meryem El Moulat, Saïd Mahmoudi, Slimane Boukraa, Pierre Manneback, Frédéric Lebeau. "Web Monitoring of Bee Health for Researchers and Beekeepers Based on the Internet of Things". Conference FAMS 2018.

Yassine Kriouile

+33 6 18 84 60 50

yassine.kriouile@mines-paristech.fr

yassine.kriouile@intervenants.efrei.fr

Download on your phone

