



HAL
open science

Towards a Unified Environmental Monitoring, Control and Data Management System for Irradiation Facilities: the CERN IRRAD Use Case

Blerina Gkotse, M. Glaser, Pierre Jouvelot, Emanuele Matli, Giuseppe Pezzullo, F. Ravotti

► **To cite this version:**

Blerina Gkotse, M. Glaser, Pierre Jouvelot, Emanuele Matli, Giuseppe Pezzullo, et al.. Towards a Unified Environmental Monitoring, Control and Data Management System for Irradiation Facilities: the CERN IRRAD Use Case. RADECS 2017, RADIATION EFFECTS ON COMPONENTS AND SYSTEMS, Oct 2017, Genève, Switzerland. hal-01622872

HAL Id: hal-01622872

<https://minesparis-psl.hal.science/hal-01622872v1>

Submitted on 24 Oct 2017

HAL is a multi-disciplinary open access archive for the deposit and dissemination of scientific research documents, whether they are published or not. The documents may come from teaching and research institutions in France or abroad, or from public or private research centers.

L'archive ouverte pluridisciplinaire **HAL**, est destinée au dépôt et à la diffusion de documents scientifiques de niveau recherche, publiés ou non, émanant des établissements d'enseignement et de recherche français ou étrangers, des laboratoires publics ou privés.



Towards a Unified Environmental Monitoring, Control and Data Management System for Irradiation Facilities: the CERN IRRAD Use Case

B. Gkotse^{1,2}, M. Glaser¹, P. Jouvelot², E. Matli¹, G. Pezzullo¹, F. Ravotti¹

¹ European Organization for Nuclear Research, CERN EP-DT-DD, Geneva, Switzerland

² MINES ParisTech, PSL Research University, Paris, France

Blerina.Gkotse@cern.ch



RADECS 2017
CERN, Geneva

ABSTRACT

The qualification of materials, electronic components and equipment for the CERN High Energy Physics experiments and beyond requires testing against possible radiation effects. These quite complex tests are performed by specialized teams working in irradiation facilities such as IRRAD, the CERN Proton Irradiation Facility. Building upon the details of the overall irradiation control, monitoring and logistical systems of IRRAD as a use case, we introduce the motivations for and the general architecture of its new data management

framework, currently under development at CERN. This infrastructure is intended to allow for the seamless and comprehensive handling of irradiation experiments in IRRAD and to help manage all aspects of the facility. Its architecture, currently focused on the specific requirements of IRRAD, is intended to be upgraded to a general framework that could be used in other irradiation facilities within the radiation effects community, as well as for other applications.

Proton Irradiation Facility IRRAD

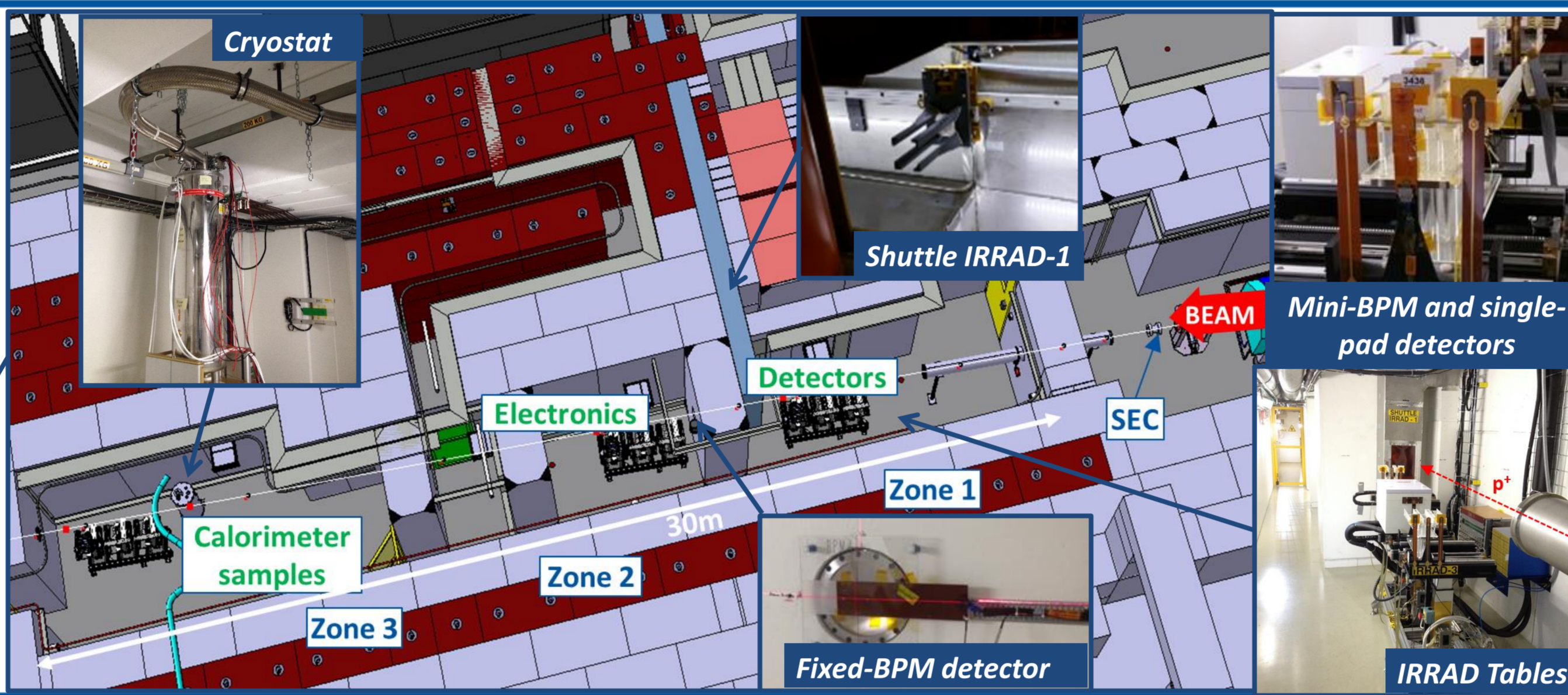
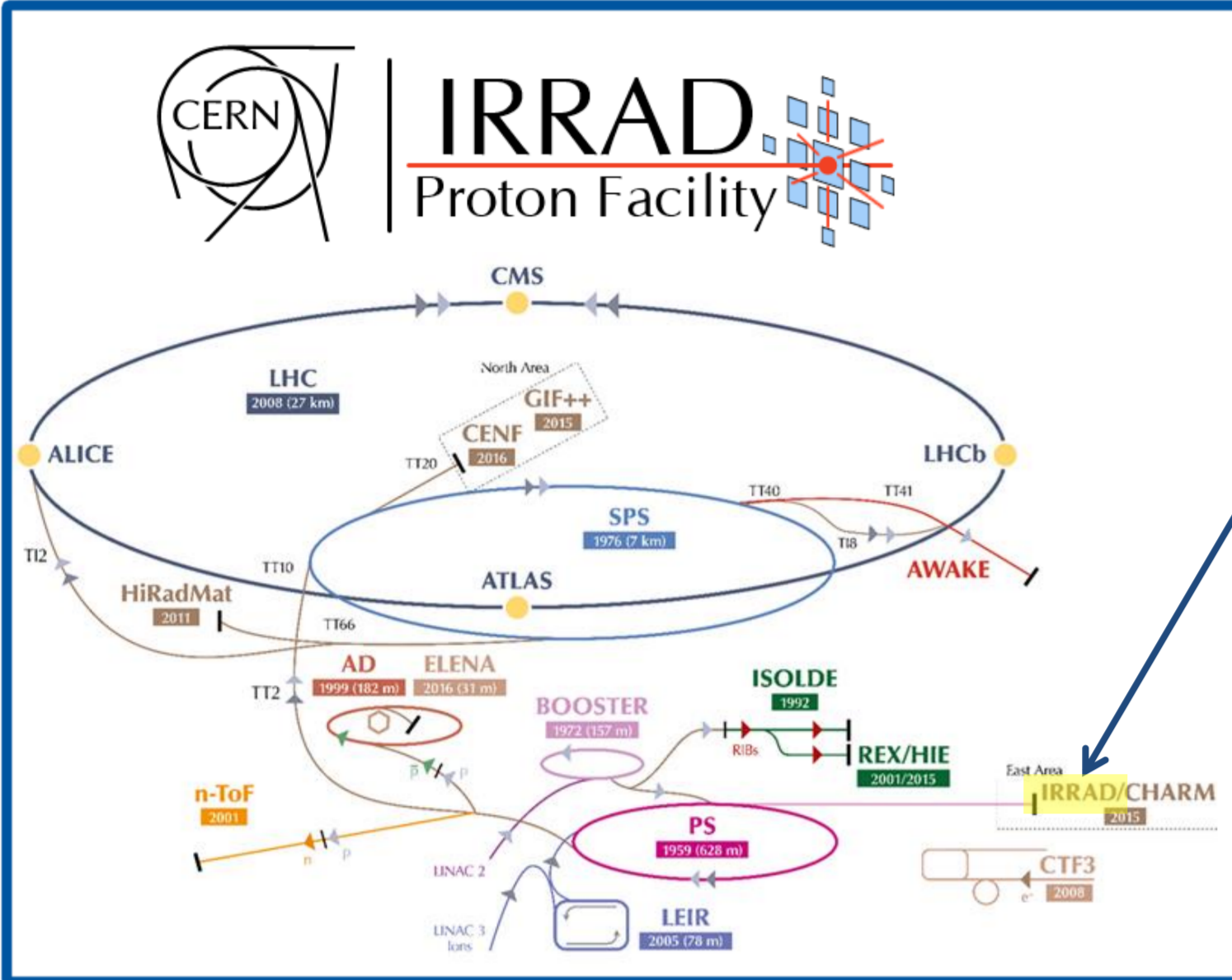

- Testing components of the HEP experiments
- Proton beam of 24 GeV/c and size of 12x12 mm²
- Spills of 400 ms every ~10 s
- Proton fluence of 1x10¹⁶ cm⁻² in 14 days
- Scanning samples across the beam (10x10cm²)
- Low temperature irradiation (-25°C)
- Cryostat with LHe at 1.9K



Irradiation System Control

IRRAD Tables

The IRRAD tables are used to remotely control and position samples of different types and shapes in beam. They can move along the transversal beam direction (X, Y) and rotate around it (θ).

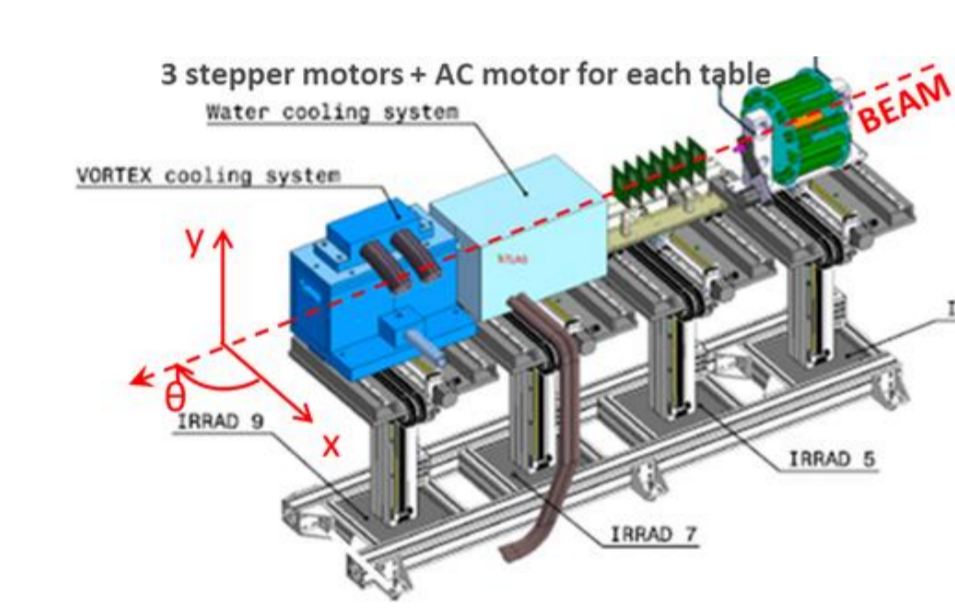

IRRAD tables



User interface of the IRRAD table control system

Shuttle IRRAD-1

The IRRAD1 shuttle is a conveyer moving on a rail and it is used to remotely place small (max. 5x5cm²) samples from outside to the inside of IRRAD.

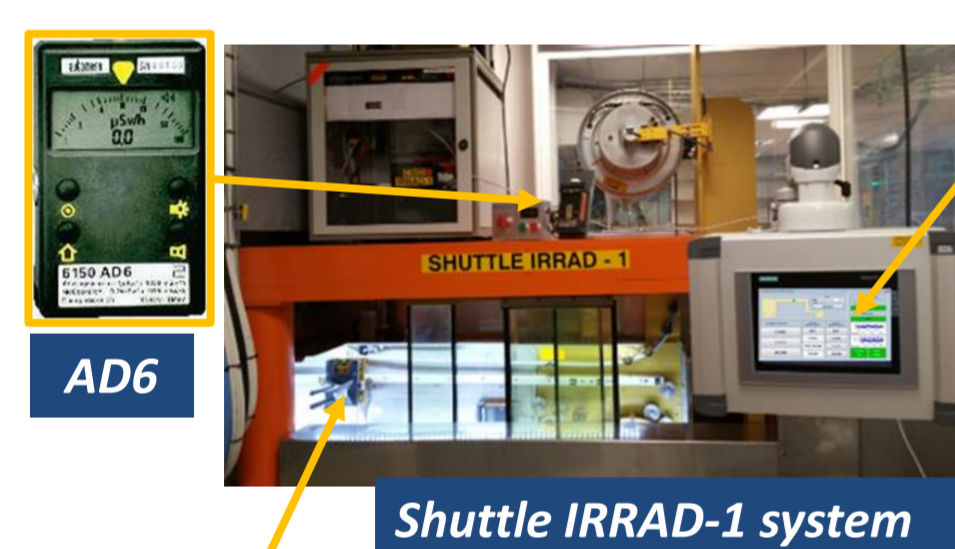

Shuttle IRRAD-1 system

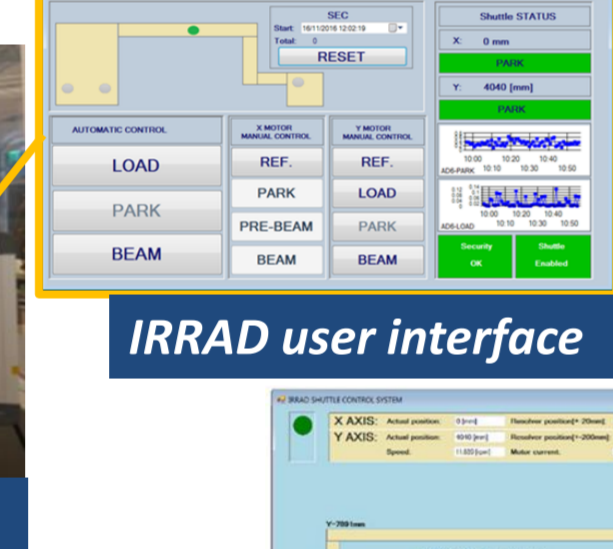

IRRAD user interface



Shuttle Conveyer

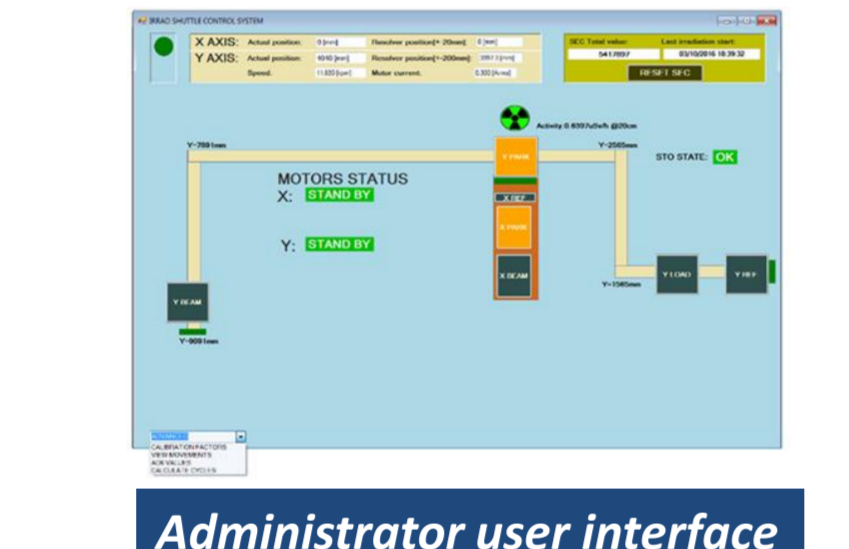

Administrator user interface

Beam Instrumentation

Fixed-BPM

The fixed-BPM detector is composed of arrays of 4x4 mm² Cu pads and it is used to control the position and the alignment of the beam. When the beam impinges on the detector, the charge generated due the Secondary Electron Emission is recorded by a DAQ unit. The acquired data are then sent to a server and, after processing, they are stored in an Oracle database. The data are then visualised on a website.

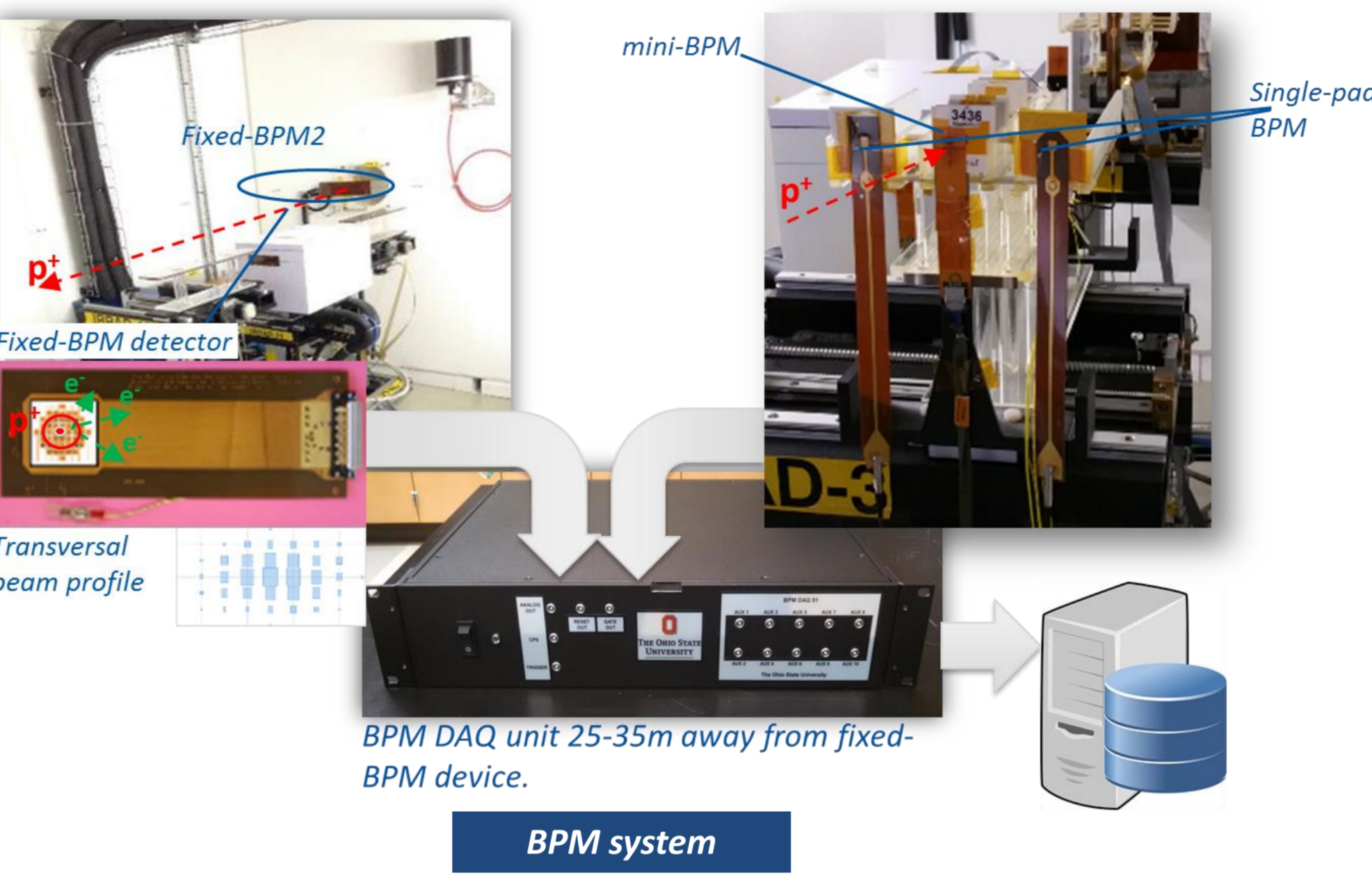

BPM system

Mini-BPM and single-pad BPM

The mini-BPM and single-pad BPM are smaller detectors than the fixed-BPM, but of the same composition and DAQ system. They are used to align the IRRAD Tables in the beam.

Environmental monitoring

For monitoring the environmental conditions of the facility, IRRAD is equipped with a complete monitoring system. 500 channels are monitored for each spill:

- ✓ Temperature
- ✓ IRRAD Tables and shuttle positions
- ✓ Radiation
- ✓ Beam intensities

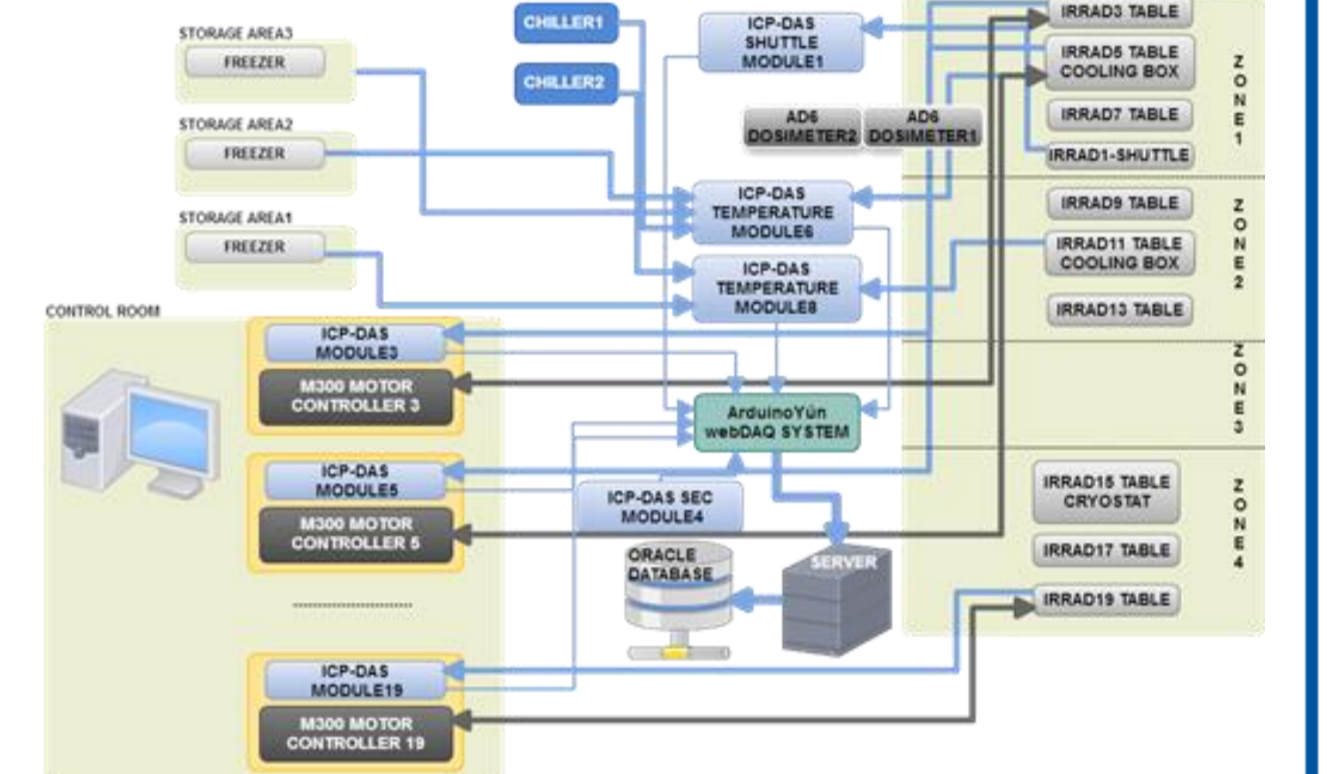

The data acquired are used in daily operation and displayed in dedicated status panels.



Status panel

IRRAD Data Management System

416 samples were irradiated in 2016 and this number is increasing year by year. The amount of data to be processed (samples and users data, those described in the sections above and additional information from spectrometry and samples traceability) call for an intelligent and integrated data management system.

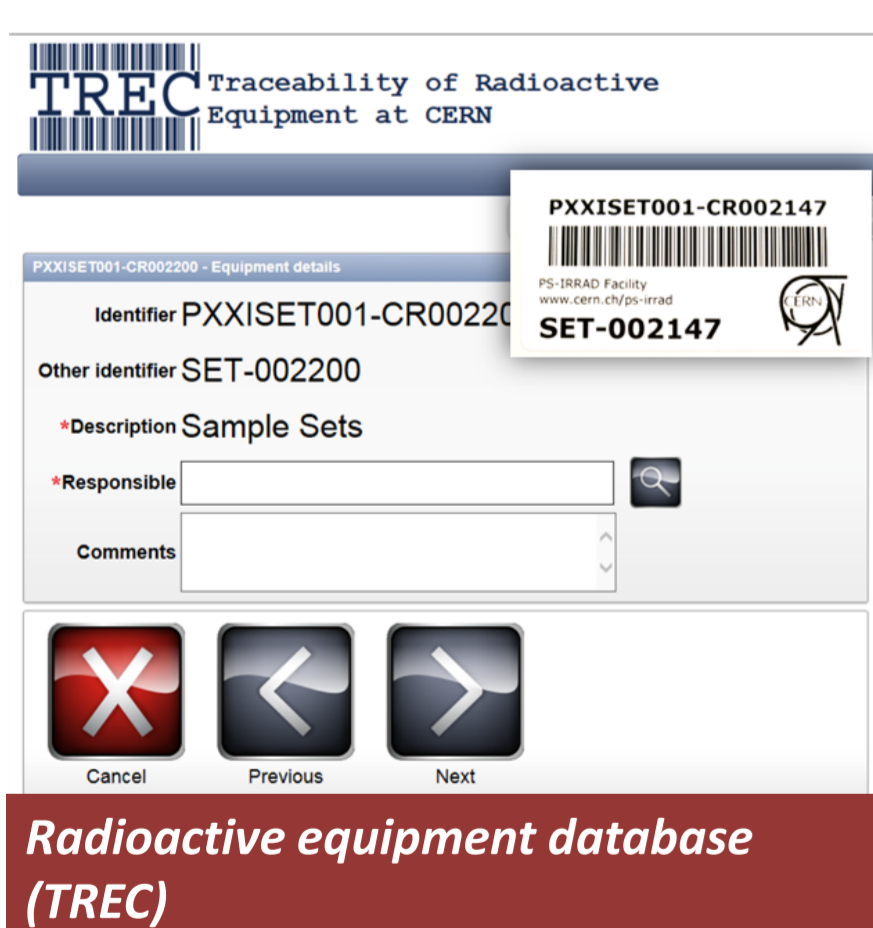

Radioactive equipment database (TREC)

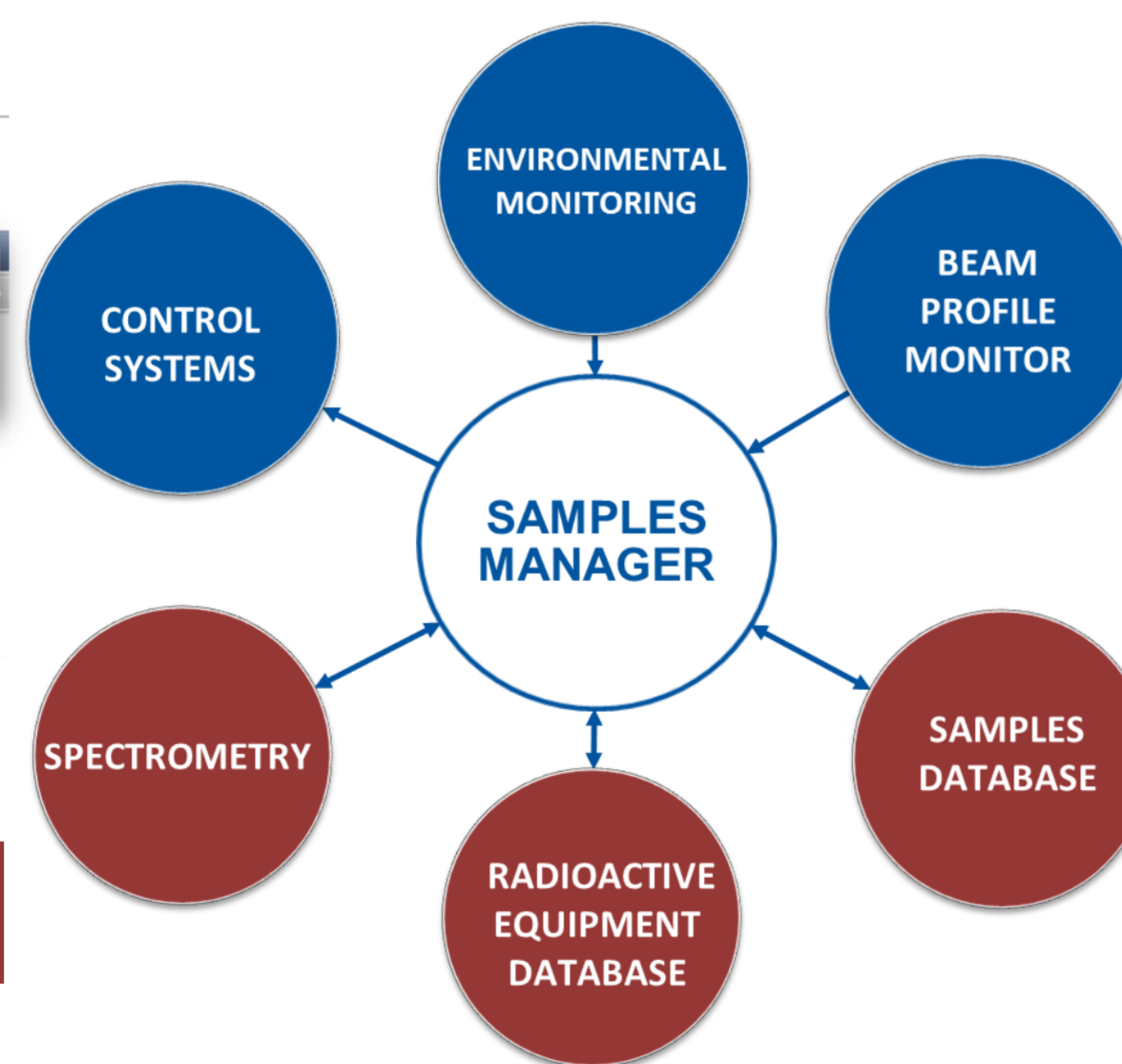

IRRAD data management system development process

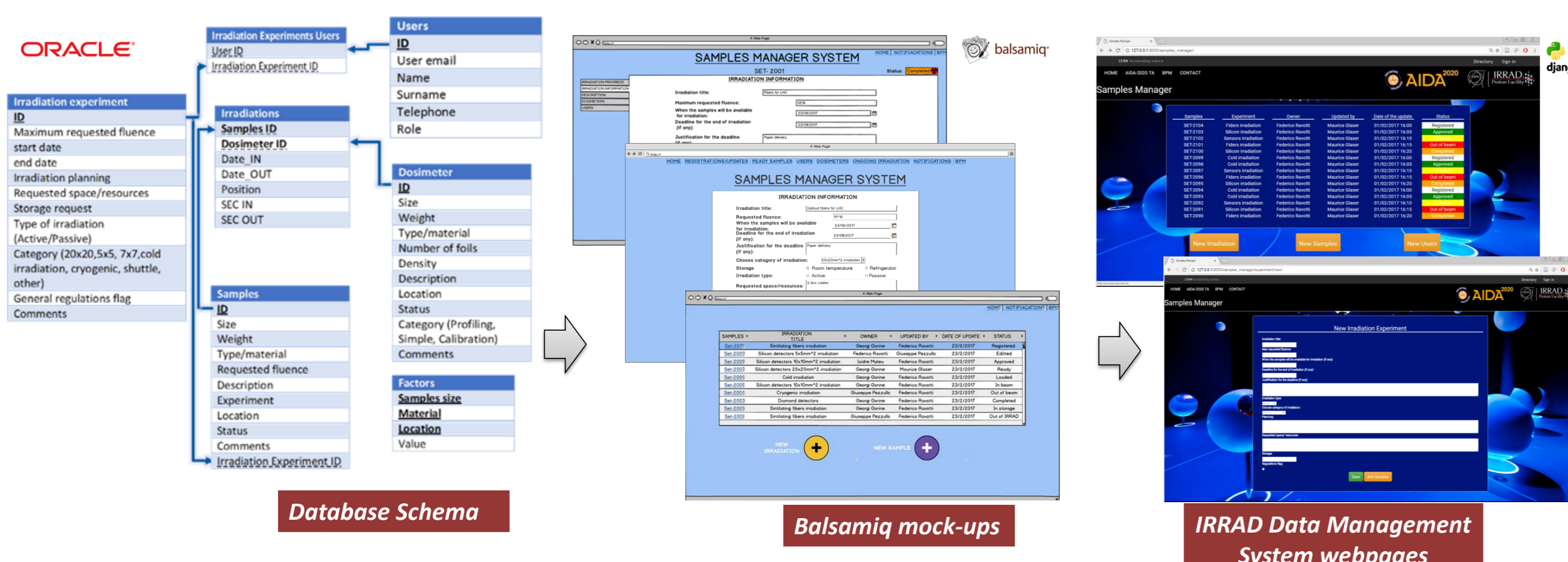

Database Schema

Balsamiq mock-ups

IRRAD Data Management System webpages

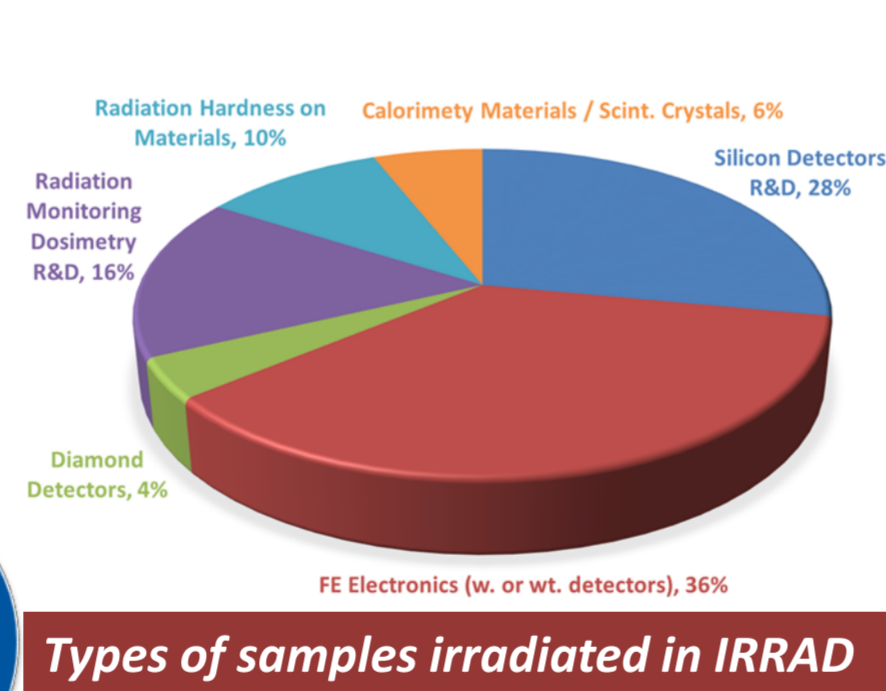

Types of samples irradiated in IRRAD

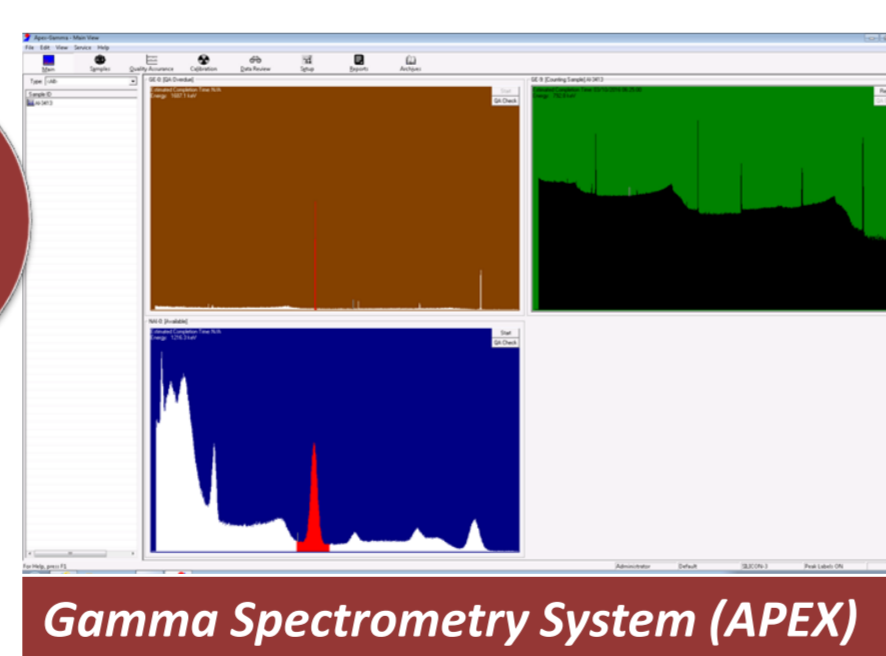

Gamma Spectrometry System (APEX)

Towards a Unique Irradiation Facility Framework

Motivations

After an extensive survey about the irradiation facilities available worldwide we found:

- Manual operations or even on paper
- Autonomous operations, with specific technologies
- Outdated systems
- Poor or absence of data management
- Lack of a common knowledge base shared among the irradiation facilities

The irradiation facilities need to share the same knowledge base and follow a common model

For this reason we propose an irradiation facility ontology. An ontology is an assembly of definitions, properties and interrelations among entities of a specific domain, in this case the irradiation facilities.

Irradiation Facility Framework (IFF)

- ✓ Adaptive
- ✓ Multi-profile
- ✓ Platform-independent

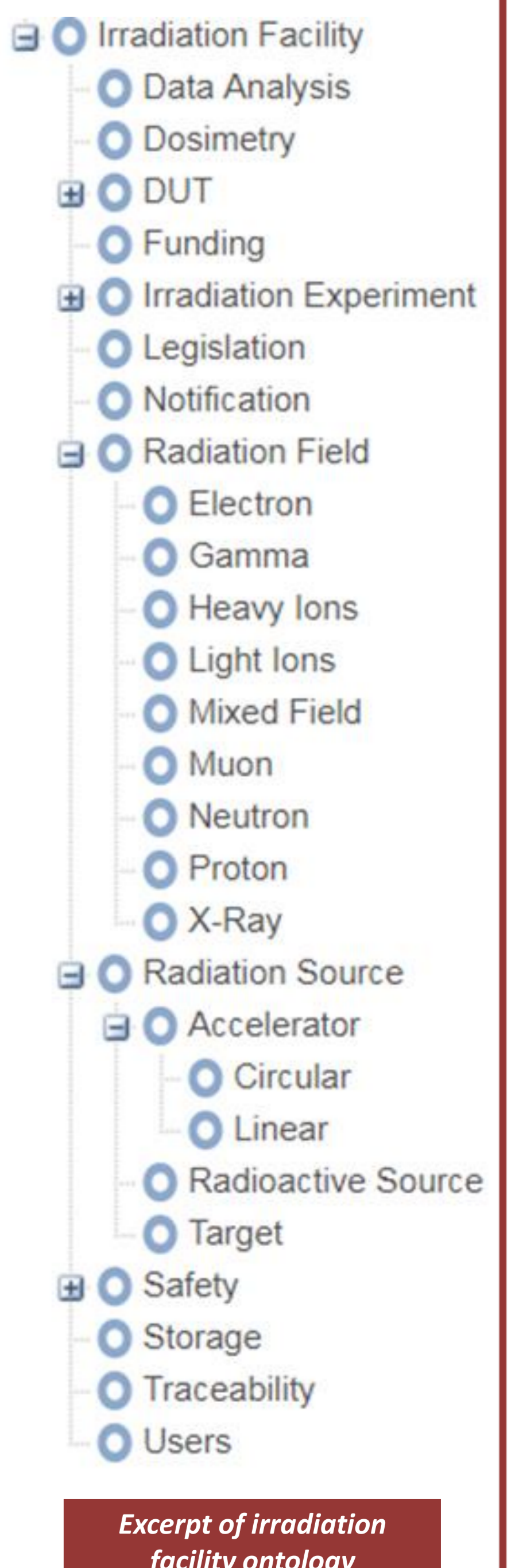

Excerpt of irradiation facility ontology

