



HAL
open science

An Advanced Control System for Wind/Diesel Power Systems

Eric Nogaret, Georges Stavrakakis, Georges Kariniotakis, Michael Papadopoulos, Nikos Hatziargyriou, Aris Androutsos, Stavros Papathanassiou, Joao Abel Peças Lopes, Jim Halliday, Geoff Dutton, et al.

► **To cite this version:**

Eric Nogaret, Georges Stavrakakis, Georges Kariniotakis, Michael Papadopoulos, Nikos Hatziargyriou, et al.. An Advanced Control System for Wind/Diesel Power Systems. European Union Wind Energy Conference EUWEC'96, May 1996, Göteborg, Sweden. hal-01568348

HAL Id: hal-01568348

<https://minesparis-psl.hal.science/hal-01568348>

Submitted on 19 Oct 2022

HAL is a multi-disciplinary open access archive for the deposit and dissemination of scientific research documents, whether they are published or not. The documents may come from teaching and research institutions in France or abroad, or from public or private research centers.

L'archive ouverte pluridisciplinaire **HAL**, est destinée au dépôt et à la diffusion de documents scientifiques de niveau recherche, publiés ou non, émanant des établissements d'enseignement et de recherche français ou étrangers, des laboratoires publics ou privés.

AN ADVANCED CONTROL SYSTEM FOR WIND DIESEL POWER SYSTEMS.

E. Nogaret, G. Stavrakakis, G. Kariniotakis M. Papadopoulos, N. Hatzargyriou, A. Androutsos, S. Papathanassiou
Ecole des Mines de Paris, France National Technical University of Athens, Greece

J.A. Peças Lopes
INESC, Portugal

J. Halliday, G. Dutton
Rutherford Appleton Laboratory, U.K

J. Gatopoulos, V. Karagounis
AMBER S.A., Greece

ABSTRACT - In this paper an advanced control system for the optimal operation and management of medium-sized autonomous wind-diesel power systems is presented. This control system minimises the production costs through an on-line optimal scheduling of the power units, which takes into account the technical constraints of the diesel-units, as well as short-term forecasts of the load and the renewable resources. The power system security is maximised through on-line security assessment modules, which enable the power system to withstand sudden changes in the production of the renewable sources. The control system was evaluated using data from the island of Lemnos, where it has been installed and operates since January 1995.

Keywords : Wind-Diesel Systems, Control Systems, Economic Dispatch, Forecasts, Security Assessment.

1. INTRODUCTION

Autonomous power systems, usually in islands, represent a large potential for the installation of wind farms and PV plants, especially if important wind and solar resources are available, due to the high cost of conventional electricity production. However, in order to achieve a high level of integration of renewable energy plants, while maintaining a high level of security in the system, an advanced control system must be available to help the power system operators.

The objective of the European Community JOULE II Project N° J0U2-CT92-0053 has been to develop such an advanced control system that has been installed on the Greek island of Lemnos.

The developed control system aims to assist the operator of a medium-size autonomous power system by proposing optimal dispatching scenarios for the various power units, as well as the various actions needed to avoid dangerous situations which might result from a poor prediction of load or weather or unforeseen disturbances.

The control system minimises the production costs through an on-line optimal scheduling of the power units which takes into account the technical constraints of the diesel-units as well as short-term forecasts of the load and the renewable resources.

The power system security is certified by an on-line security assessment module, which supervises the scheduling of the power units and enables the power system to withstand a number of perturbations caused by the renewable sources without exceeding acceptable limits of frequency variations.

Special attention is given to the monitoring of the security margin defined by the frequency deviation during emergency situations, such as sudden power variations from the renewable units.

An advanced software, having real-time performance and a sophisticated man machine interface, has been developed. The various modules, that perform the control system functions, have been integrated in the software and

validated with real data obtained by the existing data acquisition system of Lemnos.

2. THE CONTROL SYSTEM

The developed control system is designed to produce optimal scenarios, both from the economic and security point of view, for the power system operation. For this purpose, various functions have been developed and integrated in the control system structure, which is shown in Fig. 1, and they are performed periodically as described below :

i) *DATA-BASE* : Initially, a data-base is continuously updated by a Data Acquisition system (SCADA). The data include wind speed and solar radiation, power output for the conventional and renewable units, load consumption levels, temperature, etc. The data-base checks for errors, filters erroneous data and translates the incoming information to be accessed by the control software. The data-base incorporates also the necessary comprehensive information about the entire system - e.g. the various machine parameters.

ii) *FORECASTING-MODULES* : Using these data and other fixed parameters, the expected load and renewable power are forecast for a period equal to the planning period (e.g. 2 hours) with a time-step equal to the time step used by the dispatching module to take decisions (e.g. 10 min).

The principal method used for load forecasting is the Winter method [1], which is based on exponential smoothing and takes into account seasonal variations. Concerning wind power forecasting, various simple methods (Persistence) as well as advanced ones (Neural network based [1]) have been considered.

iii) *ECONOMIC DISPATCH (ED) MODULE* : The economic dispatch forms the basis of the real-time control system. It is based on time series analysis and simulates a number of diesel units working in parallel. Emphasis is given in the detailed representation of the start and stop



procedures. The individual technical characteristics of each unit, e.g. characteristic fuel consumption curve, are taken into account. The model simulates arbitrary number of wind parks and PV plants.

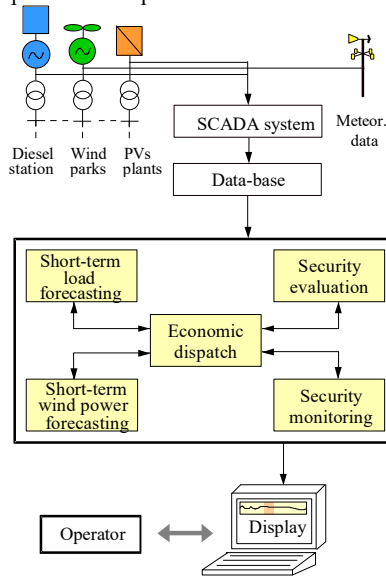

Figure 1 : The control system architecture.

Taking into account the forecast load and renewable power, the dispatching module schedules the operation of the system for the next time period (e.g. two hours taking decisions every 10 min.) so that maximum fuel saving is achieved, without deterioration of the quality of service to the consumers of the power system. The influence of the load and the renewable sources fluctuations on the system performance is assessed using a smaller time step in the order of 1 minute.

iv) **ON-LINE SECURITY ASSESSMENT MODULES :** The quality of service concerns mainly loss of load events due to a possible deficit between generation and demand, as well as dynamic instabilities and important frequency deviations due to sudden wind speed or solar radiation fluctuations. Both are related to the diesel spinning reserve provided during the scheduling of the operation of the system. Due to the importance of the dynamic behaviour in system operation, the advanced control system includes two modules responsible for the on-line evaluation of the dynamic security relative to pre-specified wind disturbances. These modules are :

- the dynamic security assessment (DSA) ;
- the security monitoring (SM).

The DSA module checks if the actions proposed by the dispatching module operation scenarios might lead to dynamically unsafe situations. If yes, these scenarios are rejected and the output of the dispatching module is revised.

The SM module provides a real-time quantitative evaluation of the system security for its current operating state, expressed by its frequency deviations if a number of preselected power disturbances from the renewable sources occurs.

Both the DSA and SM modules should provide very fast evaluations of dynamic security and high performance rates (i.e. small security misclassification rates) and enough accuracy when evaluating the degree of system security. In addition explanations were desired, e.g. why some dispatching policies are insecure.

Therefore in order to obtain fast, credible and easily interpreted results, Artificial Intelligence techniques were used for the elaboration of efficient automatic security evaluation functions. Namely the Decision Tree method was used to obtain the function of the DSA module while the Artificial Neural Network method was used for the function of the SM module [1].

3. ISSUES ON THE CONTROL ALGORITHM

The main operations of the control system are performed in two different time steps; one-minute (basic) and ten-minute (decision-forecasting) steps.

One-minute time step. The following actions are performed on an one-minute basis :

- All operational data of the power system are collected by the ED module after communication with the data-base.
- The ED module calculates the diesel station load and checks the operation limits of the diesel units.
 - if the lower acceptable operation limit of the diesel units is violated some wind turbines are stopped.
 - if a diesel unit is overloaded, a part of the load is rejected by a load management command.

Ten-minute time step. The following actions are performed on a ten-minute basis :

- The forecasting modules generate forecasts of the load and renewable power for a period of two or three hours ahead with a time step of 10-min. These forecasts are provided to the ED module.
- Decisions are made by the ED module on which diesel generator is going to be started or stopped by taking into account the following factors :
 - a priority list of the available diesel units (running or not),
 - the forecast load and renewable power for the planning period under consideration as well as factors expressing the uncertainty of the forecasts,
 - the required spinning reserve of the diesel units as a function of the load and the wind and solar margins,
 - the cost optimisation of the diesel station operation for the planning period.
- the DSA module examines if the action proposed by the ED module dispatching scenario is dynamically safe for the power system. If not, this scenario is revised and the previous step is repeated.

4. IMPLEMENTATION

The various functions of the control system have been implemented as independent modules in the control software. This modular structure permits the testing of various different methods that perform the same function, e.g. various forecasting or operational planning methods.

The security assessment rules of the DSA module have been implemented within an expert system shell which permits their visualisation by the operators. This is particularly important for the understanding of the reasoning followed by the control system when taking decisions concerning the power system security.

An advanced man-machine interface has been designed so that the control system is ergonomic and

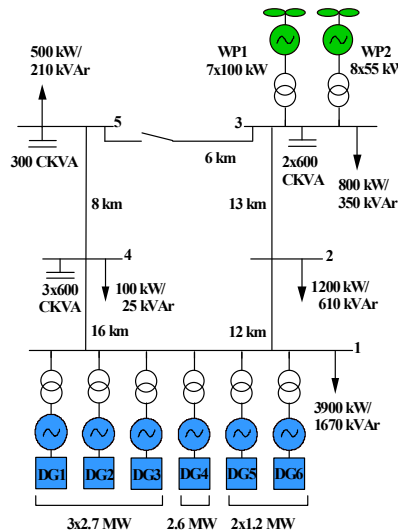

Fig. 2 : One-line diagram of the power system of Lemnos.

friendly to the user. The operators can easily communicate with the control system in order to obtain data on the power system behaviour in graphical form. Special attention has been given to the presentation of the proposed schedules, the predicted load and wind power profiles, the various actions that are proposed in critical situations, recording of historical information and finally on monitoring the power system security.

A multi-tasking operating system - Windows NT - provides the real-time performance required by the project. The type of computer chosen for the implementation is a PC 486.

5. THE CASE-STUDY OF THE ISLAND OF LEMNOS

Lemnos island, located at the Northern Aegean Sea, was chosen for the implementation of the Control System. The power system of the island consists of an autonomous Diesel Power Station (ADS) and two Wind Parks installed at Vigla (WP1) and Vounaros (WP2) sites. The one-line diagram of the power system is given in Fig. 2. As regards fuel consumption, the "large" diesel generator units (DG1-DG4) utilise medium fuel oil, while the "small" units (DG5-DG6) consume gas fuel oil. The "large" diesel units are considered as "base load" units, namely at least one of these has to be always in operation. The "small" units are portable, while a seventh unit of 150 kW is used only in case of emergency.

6. EVALUATION OF THE CONTROL SYSTEM

The evaluation of the control system performance has been done in two stages. The first stage included the testing of the various modules as well as of the entire software by using data files obtained by the SCADA system of Lemnos. The second evaluation phase has been performed on-site after the control system installation and initial tuning (January 1995) and the training of the operators. The control system performances and its use by the operators have been evaluated on-site.

However, major damage to the wind farms as well as to the telecommunication lines has been caused by heavy storms on the island in Spring 1995. The Greek utility (PPC) has decided to undertake a complete rehabilitation of the farms in order to install new electric generators in the wind turbines. For that reason the operators have not been able to fully use the capability of the new control system.

In this Section, available on-line simulation results are presented using a set of real wind and power data recorded in Lemnos in February 1994. During the simulation, the system operates exactly as in Lemnos, receiving data from the SCADA system and performing all its functions in detail. The only difference with the system operating on-site is that the data input from the SCADA is substituted by the recorded data file.

A typical day of the Lemnos power system operation (February 10, 1994) is presented in Fig. 3 (a-d). The presented data have been registered by the SCADA system with a time-step of one-minute.

Fig. 4 shows the commands that would have been issued by the control system to the operator, if it was in operation during that day. For the better understanding of the control operation, the Command Code of Table 1 has to be considered as regards the Diesel Generator Units.

Follow-up of these commands contributes to an improved comprehension of the control system operation. It must be noticed that the "Dispatching" commands are issued half an hour earlier than the time of the forecast change, in order to give time to the operator to act. The following key instants are characteristic of the system operation :

At 1:40 a "large" unit stops and a part of the load is taken over by a "small" unit which starts at the same time. The ED-module does not give a similar command but it is informed about this operation by the SCADA and it does not suggest any change to the previous state. Later, at 3:40, the ED-module suggests to the operator to stop the "small" unit, considering that there is enough reserve due to the high wind production. As long as the operator does not conform to the suggestions of the ED-module, the control system continues to give the same command (three times more in this case).

Later it can be observed that the demand rises, however the control system does not consider it necessary to propose any change in production. Later in the morning (5:50), it suggests to the operator to start a "large" unit replacing the "small" one. The operator reacts with some delay and the ED-module issues the same suggestion until it is realised. At noon, for some unclear reason, a "small" unit starts and operates for half hour. As soon as the ED-module recognises this, it gives an immediate command to stop the "small" unit. At about 17:30 "Dispatching"

suggests to start a "large" unit in time. The operator prefers a "small" unit instead of a "large" one and the ED-module does not suggest a new change, since it seems that after a short time (2 hours) none of these units is necessary. Therefore, at 19:30 the ED-module suggests to the operator to stop the "small" unit. As before, there is no reaction from the operator and the ED-module keeps

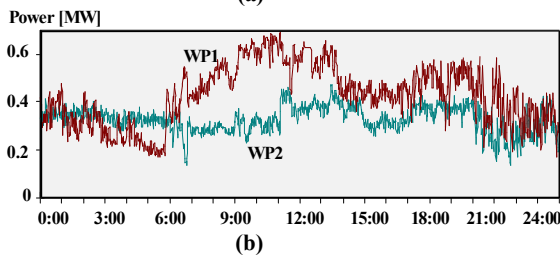
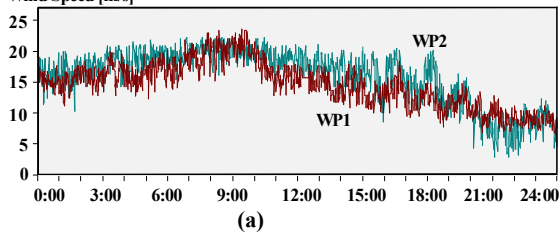

repeating the same suggestion until 21:20 when the "small" unit stops.

Analysis of the system operation during several days provides similar observations. These results suggest that the developed control system performs in close agreement

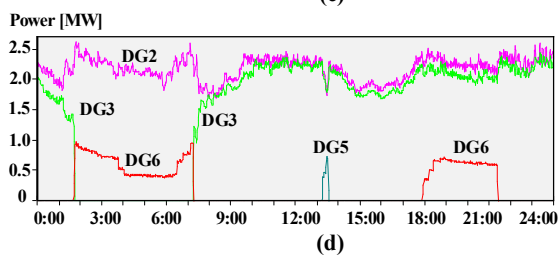
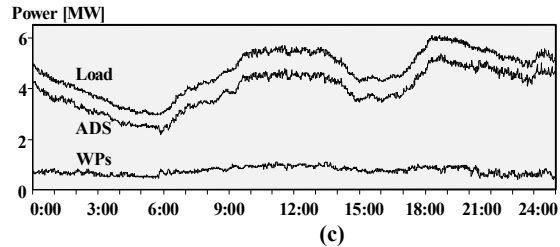

Figure 3 : Operation of the Lemnos power system on Feb. 10, 1994.

(a) Wind speed at each one of the two wind parks WP1 and WP2. (b) Total power output of each wind park. (c) Load, total diesel production (ADS) and total wind power production (WPs). (d) Production of each diesel unit.

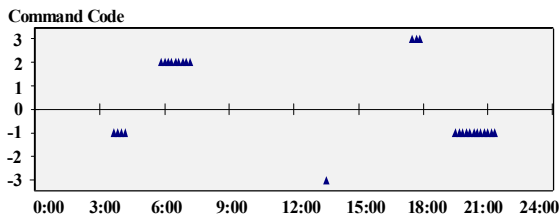

Figure 4 : Operations suggested by the control system.

TABLE I : Code for switching operations of the diesel units

| Code | Command |
|------|--|
| +3 | Start a "Large" Unit |
| +2 | Start a "Large" Unit & Stop a "Small" Unit |
| +1 | Start a "Small" Unit |
| -1 | Stop a "Small" Unit |
| -2 | Stop a "Large" Unit & Start a "Small" Unit |
| -3 | Stop a "Large" Unit |

to the actual practice followed by the operators. The following remarks may be generally derived :

- The ED module operates the diesel units in a way similar to the one followed in practice by the operator. For example, the "Dispatching" gives in time the "+3" command (start a "large") at about 18:00 every evening.
- The ED module favours the utilisation of the "large" units instead of the "small" ones. This is more clear during the first hours of the day (around 2:00 or 3:00) when the operator usually starts a "small" unit substituting a "large" one. The ED module gives no such command. On the contrary, few hours later (5:00-6:00) it suggests to the

operator to start a "large" unit replacing the "small". Practically this happens later at around 7:00.

This difference can be easily explained if fuel cost is considered. It has been observed that the operator does not take into account the lower cost of the MFO (consumed by the "large" units) compared to this of the GFO (consumed by the "small" units). Therefore, the ED module suggests the utilisation of the "large" units" more frequently leading to a

lower operation cost.

- There are operator actions that cannot be directly explained. For example, in the noon of the second day (11 Feb.) there was a substitution of a "large" by a "small" unit. Shortly, half an hour later, another "large" unit was started. This operation is clearly uneconomical, however most probably it was necessary due to some other factors unknown to us.

7. CONCLUSIONS

A pilot control system has been developed to optimise the operation of a wind-diesel system both from the economic and security point of view. Its development has been based on advanced modelling of the power system's static and dynamic characteristics. The control system has been installed on the island of Lemnos and is under continuous evaluation in order to test its performance in long-term. The initial evaluation results prove that significant benefits may be gained by its use. Finally, the control system, being developed in a flexible way, may be applied easily in the case of other power systems than

Lemnos. Guidelines for further applications are provided in [1].

REFERENCES

[1] ARMINES, NTUA, INESC, RAL, PPC *Development and implementation of an advanced control system for the optimal operation and management of medium-sized power systems with a large penetration from renewable power sources*, Final report of EU-DG XII JOULE II project JOU2-CT92-0053. Edited by the Office for Official Publications of the European Communities, Luxembourg 1996.

ACKNOWLEDGEMENT

The authors would like to thank the EU for funding this project (JOULE II : JOU2-CT92-0053). The Greek utility of PPC is thanked for its important support to this project.