



**HAL**  
open science

## Hydrate equilibrium data for the CO<sub>2</sub> + N<sub>2</sub> system with the use of Tetra-n-butylammonium bromide (TBAB), cyclopentane (CP) and their mixture

Tzirakis Fragkiskos, Paolo Stringari, Nicolas von Solms, Christophe Coquelet,  
Georgios Kontogeorgis

► **To cite this version:**

Tzirakis Fragkiskos, Paolo Stringari, Nicolas von Solms, Christophe Coquelet, Georgios Kontogeorgis. Hydrate equilibrium data for the CO<sub>2</sub> + N<sub>2</sub> system with the use of Tetra-n-butylammonium bromide (TBAB), cyclopentane (CP) and their mixture. *Fluid Phase Equilibria*, 2016, 408, pp.240-247. 10.1016/j.fluid.2015.09.021 . hal-01202617

**HAL Id: hal-01202617**

**<https://minesparis-psl.hal.science/hal-01202617>**

Submitted on 2 Oct 2015

**HAL** is a multi-disciplinary open access archive for the deposit and dissemination of scientific research documents, whether they are published or not. The documents may come from teaching and research institutions in France or abroad, or from public or private research centers.

L'archive ouverte pluridisciplinaire **HAL**, est destinée au dépôt et à la diffusion de documents scientifiques de niveau recherche, publiés ou non, émanant des établissements d'enseignement et de recherche français ou étrangers, des laboratoires publics ou privés.

# Accepted Manuscript

Hydrate equilibrium data for the CO<sub>2</sub>+N<sub>2</sub> system with the use of Tetra-n-butylammonium bromide (TBAB), cyclopentane (CP) and their mixture

Fragkiskos Tzirakis, Paolo Stringari, Nicolas von Solms, Christophe Coquelet, Georgios M. Kontogeorgis

PII: S0378-3812(15)30126-6

DOI: [10.1016/j.fluid.2015.09.021](https://doi.org/10.1016/j.fluid.2015.09.021)

Reference: FLUID 10763

To appear in: *Fluid Phase Equilibria*

Received Date: 8 May 2015

Revised Date: 4 September 2015

Accepted Date: 7 September 2015

Please cite this article as: F. Tzirakis, P. Stringari, N. von Solms, C. Coquelet, G.M. Kontogeorgis, Hydrate equilibrium data for the CO<sub>2</sub>+N<sub>2</sub> system with the use of Tetra-n-butylammonium bromide (TBAB), cyclopentane (CP) and their mixture, *Fluid Phase Equilibria* (2015), doi: 10.1016/j.fluid.2015.09.021.

This is a PDF file of an unedited manuscript that has been accepted for publication. As a service to our customers we are providing this early version of the manuscript. The manuscript will undergo copyediting, typesetting, and review of the resulting proof before it is published in its final form. Please note that during the production process errors may be discovered which could affect the content, and all legal disclaimers that apply to the journal pertain.

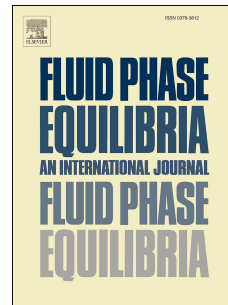

# Hydrate equilibrium data for the CO<sub>2</sub>+N<sub>2</sub> system with the use of Tetra-n-butylammonium bromide (TBAB), cyclopentane (CP) and their mixture

Fragkiskos Tzirakis<sup>1</sup>, Paolo Stringari<sup>2</sup>, Nicolas von Solms<sup>1</sup>, Christophe Coquelet<sup>2</sup> and Georgios M. Kontogeorgis<sup>1</sup>

<sup>1</sup>Center for Energy Resources Engineering, Department of Chemical and Biochemical Engineering, Technical University of Denmark, DK-2800 Kgs. Lyngby, Denmark

<sup>2</sup>Mines ParisTech PSL Research Université CTP-Centre Thermodynamic of Processes 35 Rue Saint Honoré, 77305 Fontainebleau, France

Keywords: TBAB; CP; promotion; carbon dioxide  
Corresponding author: Fragkiskos Tzirakis, frtz@kt.dtu.dk

## Abstract

Carbon Dioxide capture and sequestration (CCS) is nowadays an important area of research for decreasing CO<sub>2</sub> emissions worldwide. Hydrates can become of great importance in the future as they form the basis for a new technology that can be used for CO<sub>2</sub> capture from flue gases (hydrate crystallization). In this work hydrate equilibrium data are measured and compared with literature data. In particular, experimental results for hydrate dissociation with several promoters are presented. The isochoric method is used to determine the gas hydrate dissociation points. Different CO<sub>2</sub>+N<sub>2</sub> gas mixtures were used with presence of promoters such as tetra-n-butylammonium bromide (TBAB), cyclopentane (CP) and mixtures of TBAB with CP. The novelty of this work is the combination of promoters, TBAB and CP, which under certain conditions induced greater pressure reduction in comparison to pure TBAB results. Concerning experiments with pure promoters, there is excellent consistency between our results and literature results for different gas mixtures and promoter concentrations. Finally, experimental uncertainties for temperature, pressure, and molar composition are also presented.

## 1. Introduction

### 1.1 CO<sub>2</sub> Separation

The capture and sequestration of CO<sub>2</sub> (CCS) has become an important area of research for treating CO<sub>2</sub> emissions. CO<sub>2</sub> separation is the most expensive step of the CCS process in terms of energy consumption [1]. Many efforts are reported in developing energy efficient and environmental friendly technologies to capture the

CO<sub>2</sub> produced in large scale power-plants, where flue gas typically contains mostly CO<sub>2</sub> and N<sub>2</sub> [2]. One novel approach to separate CO<sub>2</sub> from combustion flue gas is via gas hydrate crystallization techniques [1]. When hydrate crystals are formed from a gas mixture of CO<sub>2</sub> and other gases, the different attraction between CO<sub>2</sub> and other gases in the hydrate cages will enrich the hydrate phase in CO<sub>2</sub> and the gas phase of other gases. The hydrate phase is then dissociated by depressurization and/or heating and thus CO<sub>2</sub> is retrieved [2]. According to experimental results [3], CO<sub>2</sub> selectivity in the hydrate phase is at least four times better than that in the gas phase. For efficient design of such processes, reliable phase equilibrium data are required. Recently, novel separation processes using gas hydrate formation phenomena have been proposed in the literature [4-6]. Economic studies for such processes would focus mainly on the price of the promoters needed to reduce the pressure and increase the temperature of the separation steps since the design of other required equipment is generally simple. It seems that the industry will be interested in such investments whenever the environmental regulations are rigid and when the natural gas reserves tend to reach their half-lives. According to Kuramochi et al. [7], hydrate crystallisation when Top Gas Recycling Blast Furnace (TGRBF) and TBAB promoter are used in steel industry [3] can compete against other known methods for CO<sub>2</sub> capture such as membranes or chemical absorption.

The hydrate technology can also be used to separate other greenhouse gases such as hydrogen sulfide (H<sub>2</sub>S), sulfur hexafluoride (SF<sub>6</sub>) [6], 1,1,1,2-tetrafluoroethane (R-134a) N<sub>2</sub>, H<sub>2</sub> and CH<sub>4</sub> [8]. Other uses of hydrates include the field of oil and gas separation, desalination process, food engineering, biotechnology and separation of ionic liquids [4], [8].

## 1.2 Hydrate promoters

Hydrate promotion is a rather new field of study, less than 15 years old. Currently various promoters and mixtures of them are under examination. Promoters (or hydrate formers) are mainly organic compounds classified in two groups: thermodynamic and kinetic. The first ones extend the hydrate formation region in a *P-T* diagram. Kinetic promoters enhance the hydrate formation rate e.g. sodium dodecyl sulfate (SDS), dodecyl trimethyl ammonium chloride (DTAC). Many ionic liquids (ILs) are considered as kinds of thermodynamic promoters. ILs are organic salts that are generally liquid at room temperatures [9]. The disadvantage of using

these thermodynamic promoters is that the amount of CO<sub>2</sub> captured in the hydrate form decreases since the thermodynamic promoters occupy some water cavities [10]. Some tetra-alkylammonium halides, which are water-soluble, such as tetra butyl ammonium bromide (TBAB), tetrabutyl ammonium fluoride (TBAF), tetra butyl ammonium chloride (TBAC), and so forth, and some tetra alkyl phosphonium halides like tetra butyl phosphonium bromide (TBPB) have already been proposed as promoters of gas hydrates.

Quite recently, mixtures of promoters (THF and CP) have been tested as well. Four-phase equilibrium of CP+THF+H<sub>2</sub>O and CP+H<sub>2</sub>O hydrate system was examined by Herslund et al. [11,12] and it was observed synergetic effect of THF and CP which reduce the formation pressure and increase the formation temperature of hydrates compared to pure THF.

In general, for process development the operating temperature, minimum pressure for hydrate formation, the rate of hydrate formation and the separation efficiency should be established [13]. At TBAB 0.29 mol % fraction, the highest gas uptake is observed [14]. But the highest hydrate pressure reduction is observed at stoichiometric concentration of TBAB, e.g. 3.70 mol % [15]. At higher stoichiometrical concentration, the excess amount of TBAB can inhibit semi-clathrate formation [15]. The CO<sub>2</sub> solubility of TBAB is changing from salting-in to salting-out by decreasing TBAB concentration and temperature [16].

Cyclopentane forms emulsion at concentrations higher than 8.99 mol % [17], which deteriorates the promoter's pressure reduction efficiency. The hydrate formation rate with cyclopentane/water emulsion is higher than that with cyclopentane due to the larger contact area of gas and liquid that controls hydrate formation rate [18]. In addition, the selectivity of CO<sub>2</sub> in hydrates using cyclopentane is improved in comparison to the system without promoter. Secondly, the equilibrium pressure is drastically reduced. Unfortunately, the gas storage capacity is lowered as well [17]. Although cyclopentane is a very good promoter, it seems it stabilizes the cavities in such a way that it prevents the complete occupation of the remaining cavities by gas molecules. The dissociation temperature of CP+CO<sub>2</sub> is a little higher than that of TBAB+CO<sub>2</sub> [19].

In this study hydrate equilibrium results of thermodynamic promoters (TBAB, CP and TBAB+CP) are presented and compared with existing literature. The purpose of the study is the production of data for gas mixtures of CO<sub>2</sub> and N<sub>2</sub> with low CO<sub>2</sub> content

–which simulates flue gas composition of post combustion power plant– as well as the examination whether CP induces promotion effect together with TBAB for CO<sub>2</sub>+N<sub>2</sub> gas mixture. The literature study showed lack of results in this system while many results indeed exist for CO<sub>2</sub>+CH<sub>4</sub>+TBAB, CO<sub>2</sub>+H<sub>2</sub>+TBAB and CO<sub>2</sub>+TBAB.

## 2 Experimental section

**Materials.** The chemicals used are presented in Table 1. The gas cylinders of CO<sub>2</sub> and N<sub>2</sub> gases used in this work were supplied by Air Liquide. The molar fractions of CO<sub>2</sub> in CO<sub>2</sub>+N<sub>2</sub> gas mixture were app. 0.15, 0.11, 0.07 and 0.005. The exact concentration was measured by a gas chromatograph. TBAB solutions with mass fractions of 0.05, 0.10 and 0.20 were prepared by the gravimetric method using an accurate analytical balance (Mettler, AT200), with mass accuracy of ±0.0001 g. Double-distilled and deionized water from Direct-Q5 Ultrapure Water Systems (Millipore™), was used in all experiments. Cyclopentane at concentration of 5 vol. % was added after in all TBAB solutions with use of proper syringe.

Table 1  
Chemicals used in this study.

Name	Abbreviation	CAS-number	Purity	Supplier	Phase
Carbon dioxide	CO <sub>2</sub>	124-38-9	99.998 (Vol %)	Air Liquide	gas
Nitrogen CO-free	N <sub>2</sub>	7727-37-9	99.999 (Vol %)	Air Liquide	gas
Tetra-n-butylammonium bromide	TBAB	1643-19-2	≥99+ % (wt %)	Acros Organics	solid
Cyclopentane	CP	287-92-3	≥98 % (wt %)	Acros Organics	liquid

**Apparatus.** The schematic diagram of the experimental apparatus employed for measuring hydrate phase equilibrium points in this work is presented in Figure 1. Isochoric temperature and pressure trace method is applied. Two gas cylinders were used, one for nitrogen and one for CO<sub>2</sub> and N<sub>2</sub>. The equilibrium cell temperature is controlled using a thermostatic water bath (LAUDA PROLine RP3530). One platinum temperature probe (Pt100, JM6081) inserted in the cell interior –at the bottom (liquid phase)– was used to measure the temperature inside the equilibrium cell. The absolute temperature uncertainty is estimated to be less than  $u(T, k = 2) = 0.02$  K

after careful calibration against reference platinum probe (TINSLEY Precision Instruments). The pressure in equilibrium cell is measured using a UNIK 5000 GE absolute pressure transducer with an absolute uncertainty of  $u(P, k = 2) = 0.0015$  MPa after careful calibration against dead weigh balance.

The equilibrium cell is made of 316 stainless steel; its maximum working pressure and its inner volume is 40 MPa and 125 mL, respectively. A motor-driven turbine agitation system (Top Industrie, France) enables to stir the cell contents at a speed up to 1200 rpm to increase the fluids contact and enhance water conversion into hydrate. The data acquisition units (Agilent 34970A, HP 34970A) were connected with a personal computer. Continuous recording of pressures and temperatures allows detecting any subtle changes in the system and true equilibrium conditions.

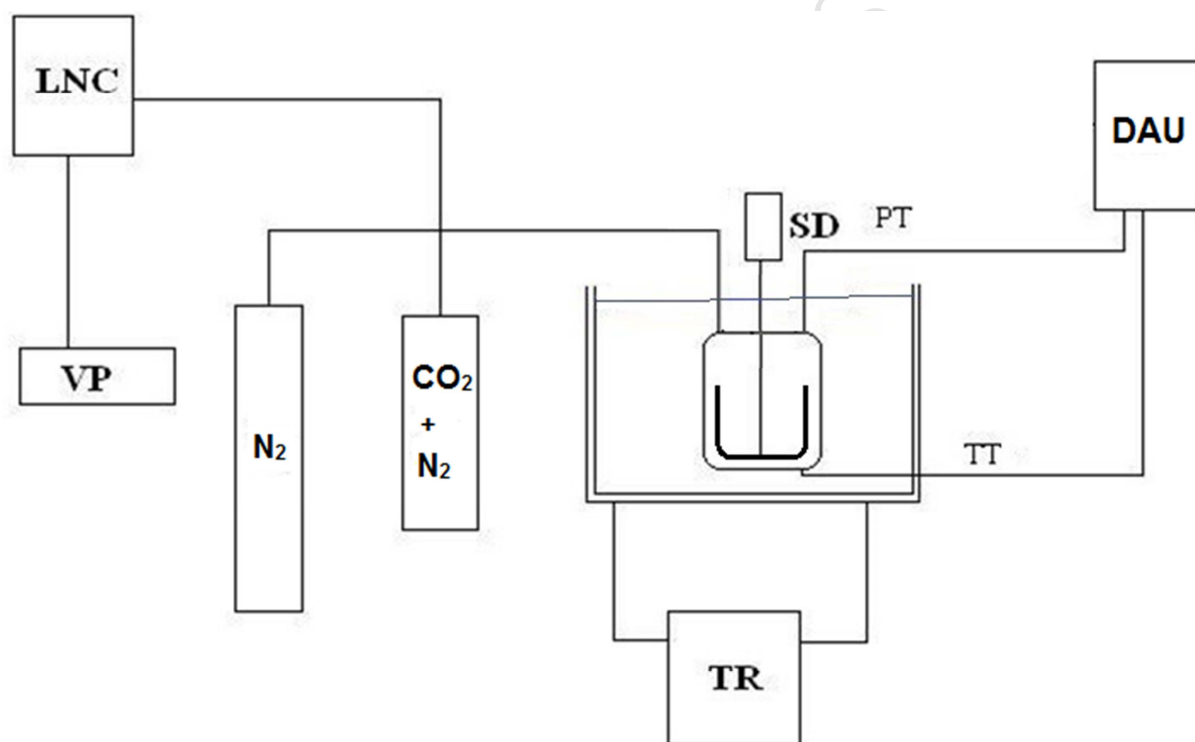

**Figure 1.** Simplified schematic diagram of equipment of gas hydrate dissociation point measurement. **LNC:** liquid nitrogen container. **VP:** vacuum pump. **SD:** stirring device. **TR:** temperature regulator. **TT:** temperature transducer. **PT:** pressure transducer. **DAU:** data acquisition unit.

**Experimental procedure.** After evacuation of the equilibrium cell using the vacuum pump (Oerlikon leybold vacuum, Trivac D2.5E), 15-40 ml of promoter solution (TBAB, CP or TBAB+CP) –that is about 20-30 vol % of the equilibrium cell– was subsequently partially filled in the equilibrium cell. Then, the gas mixture was introduced in the equilibrium cell from the cylinder. Pressure and temperature measurements under hydrate stability conditions were carried out as follows: The

equilibrium cell was immersed into the temperature-controlled bath and temperature was decreased to form hydrates, while agitating at a constant speed of about 1070 rpm. The temperature of the system was kept constant for at least 7 h to overcome the metastable period and allow complete hydrate formation, which was detected by a noticeable pressure drop and simultaneous temperature increase (desirable case) or a long-lasting minor pressure drop and sudden temperature ‘‘outbursts’’. The last case was also common and may be explained by the reaction kinetics and water memory phenomenon.

Temperature was then increased stepwise. At every temperature step, temperature was kept constant until temperature and pressure are stabilized. As implemented by Ohmura et al. [20], a pressure-temperature diagram was obtained for each experimental run from which the hydrate dissociation condition could also be determined. For measuring an equilibrium condition at a higher pressure, the pressure of the system was increased by successively supplying gas mixture to the equilibrium cell until achieving the desired pressure and then repeating the temperature cycle. In this way, several  $P$ - $T$  equilibrium data were obtained from each experimental run and eventually a  $P$ - $T$  diagram is created following temperature-pressure trace method.

### 3 Results – Discussion

#### 3.1 Results for TBAB as promoter

The TBAB results for  $\text{CO}_2+\text{N}_2$  mixture concentrations are summarized in Figure 2. The results are compared with literature data. At first, for comparison purposes, the unpromoted system  $\text{CO}_2+\text{N}_2$  is reported [21]. In general, it is observed good agreement of our results with the literature data for similar systems of 5%, 10% and 20 wt % TBAB solutions which correspond to 0.29%, 0.62% and 1.38 mol % respectively. For clarity reasons, the systems are presented by two numbers in brackets. The first number denotes the mol fraction of  $\text{CO}_2$  in  $\text{CO}_2+\text{N}_2$  gas mixture cylinder and the second one denotes the promoter concentration expressed in mol %. Black markers connected with trendlines correspond to results of this work.

From Gibbs phase rule, the parameters that suggest where the equilibrium lines should be located are the gas mixture concentration, the promoter concentration in aqueous solution and the water-to-gas ratio (mol/mol). For simplicity reasons and



also owing to the fact that gas-to-liquid ratio is not always mentioned in literature, it was omitted from this study.

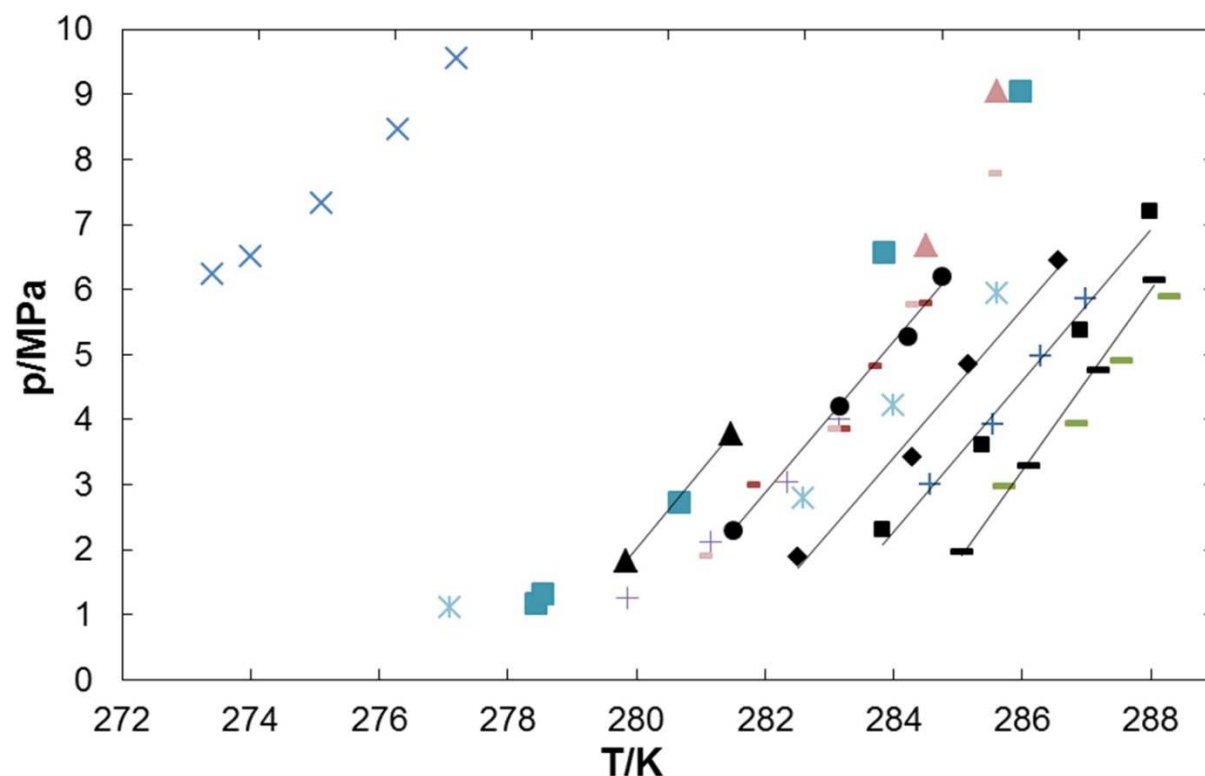

- X: (20, 0), Olsen et al. [21];
- : (15.9, 0.29), Lu et al. [22];
- ▲: (11.24, 0.29), this work;
- ▲: (15.1, 0.29), Mohammadi et al. [23];
- : (14.92, 0.29), this work;
- : (15, 0.29), Sfaxi et al. [24];
- +: (13.70, 0.29), Chen et al. [25];
- : (20, 0.29), Meysel et al. [26];
- \*: (39.9, 0.29), Mohammadi et al. [23];
- ◆: (6.87, 0.62), this work;
- +: (20, 0.62), Meysel et al. [26];
- : (14.92, 0.62), this work;
- : (6.87, 1.38), this work;
- : (20, 1.38), Meysel et al. [26].

**Figure 2.** Hydrate dissociation points for different systems using TBAB as promoter. The figure contains systems of this work and systems of  $\text{CO}_2+\text{N}_2+\text{TBAB}+\text{H}_2\text{O}$  from literature. For clarity reasons, the systems are presented by two numbers in brackets. The first number denotes the mol fraction of  $\text{CO}_2$  in  $\text{CO}_2+\text{N}_2$  gas mixture cylinder and the second one denotes the promoter concentration. Black markers connected with trendlines correspond to results of this work. References are presented according to diagram from left to right.

In general, the higher the  $\text{CO}_2$  in  $\text{CO}_2+\text{N}_2$  gas mixture concentration, the more on the right of the PT diagram the hydrate dissociation results should be located. This results in further decreasing of hydrate formation pressure. At higher temperatures,  $\text{CO}_2$  is captured easier than  $\text{N}_2$ . In modeling, the analogy of Langmuir absorption approximates successfully hydrate crystallization. So, the size and the kinetic energy of  $\text{CO}_2$  at higher temperatures enhance more  $\text{CO}_2$  capture than  $\text{N}_2$  capture.

The results of similar promoter and gas mixture concentrations are in excellent agreement, e.g. with (14.92, 0.29) from this work, with (13.70, 0.29) from Chen et al.

[25], with (20, 0.29) from Meysel et al. [26] and with (15, 0.29) from Sfaxi et al. [24]. Another observation is that the system of (6.87, 0.62) of this work is approximately placed on the left of (20, 0.62) of Meysel et al. [26] which shows that CO<sub>2</sub> hydrates are formed at lower pressures than N<sub>2</sub> hydrates.

Similarly for higher TBAB concentrations, the results of similar promoter and gas mixture concentrations are in good agreement, e.g. with (6.87, 1.38) from this work, with (20, 1.38) from Meysel et al. [26]. According to the literature, there is mismatch of (13.70, 0.29) of Chen et al. [25] with the system (15.9, 0.29) of Lu et al. [22] respectively as shown in Figure 2.

For a more detailed comparison of our results, Figures 3 and 4 include systems of this work and for CO<sub>2</sub>/N<sub>2</sub>+TBAB+H<sub>2</sub>O from literature respectively. In Figure 3 the results of this work are located between the system of pure CO<sub>2</sub> hydrate and systems of CO<sub>2</sub>+TBAB+H<sub>2</sub>O from literature. This is expected due to the high content of N<sub>2</sub> that was used in our results. The results from literature are shifted smoothly to the right hand side of the diagram as TBAB concentration increases.

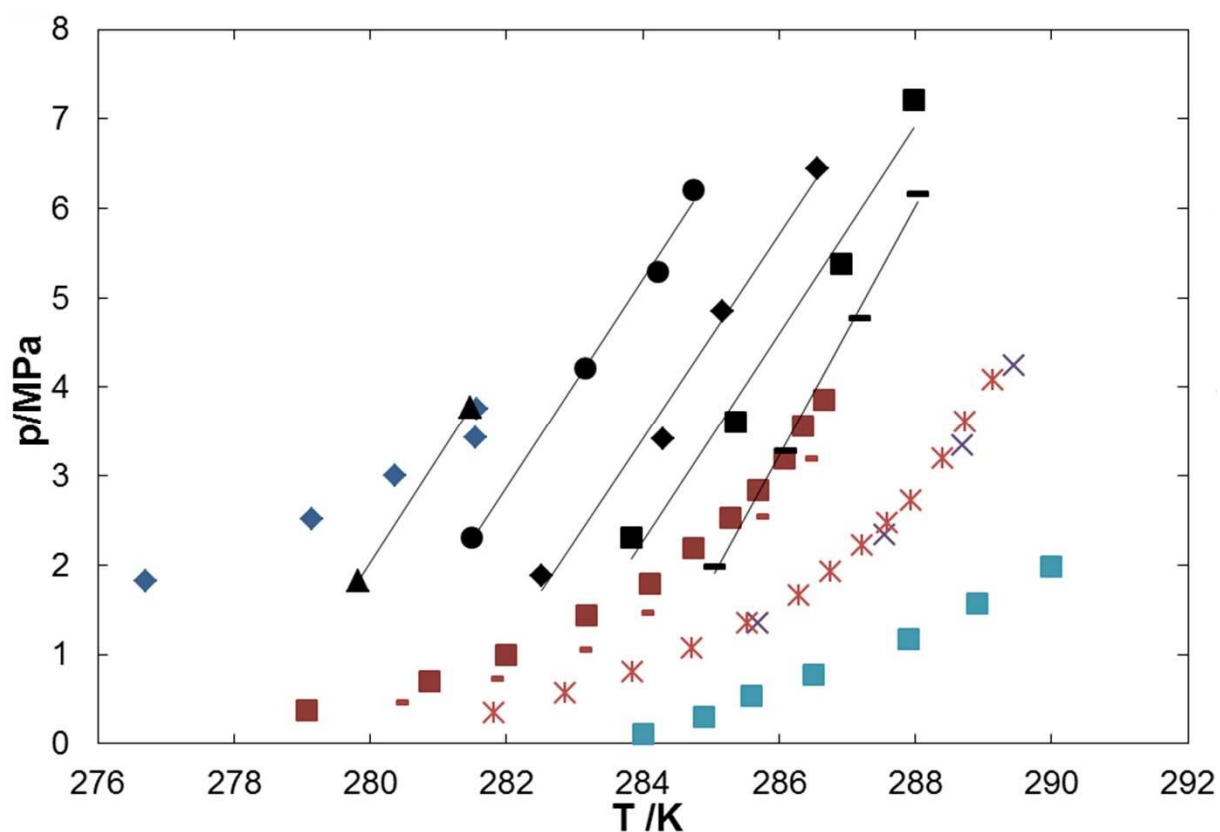

- ◆: (100, 0), Sami et al. [28];
- ▲: (11.24, 0.29), this work;
- : (14.92, 0.29), this work;
- ◆: (6.87, 0.62), this work;
- : (14.92, 0.62), this work;
- : (6.87, 1.38), this work;
- : (100, 0.29), Ye and Zhang [29];
- : (100, 0.29), Mohammadi et al. [27];
- ✕: (100, 0.62), Ye and Zhang [29];
- ✕: (100, 0.60), Lee et al. [30];
- : (100, 1.83), Mohammadi et al. [27].

**Figure 3.** Hydrate dissociation points for different systems using TBAB as promoter. The figure contains systems of this work and systems of  $\text{CO}_2+\text{TBAB}+\text{H}_2\text{O}$  from literature. For clarity reasons, the systems are presented by two numbers in brackets. The first number denotes the mol fraction of  $\text{CO}_2$  in  $\text{CO}_2+\text{N}_2$  gas mixture and the second one denotes the promoter concentration. Black markers connected with trendlines correspond to results of this work. References are presented according to diagram from left to right.

In Figure 4, our results are located between systems of  $\text{N}_2+\text{TBAB}+\text{H}_2\text{O}$  from literature. This is expected because of the high content of our gas mixture. Specifically, the system of (11.24, 0.29) of this work is located as expected on the right side of the systems of (0, 0.29), Lee et al. [31] and (0, 0.29), Mohammadi et al. [27]. The system of (6.87, 1.38) of this work coincides well with the results of (0, 3.59) from Lee et al. [31] which reveals that the addition of 6.87% of  $\text{CO}_2$  in pure  $\text{N}_2$  counteracts the additional use of 2.21 mol % TBAB in aqueous solution, which is the deduction of 3.59 mol % and 1.38 mol % of the two systems.

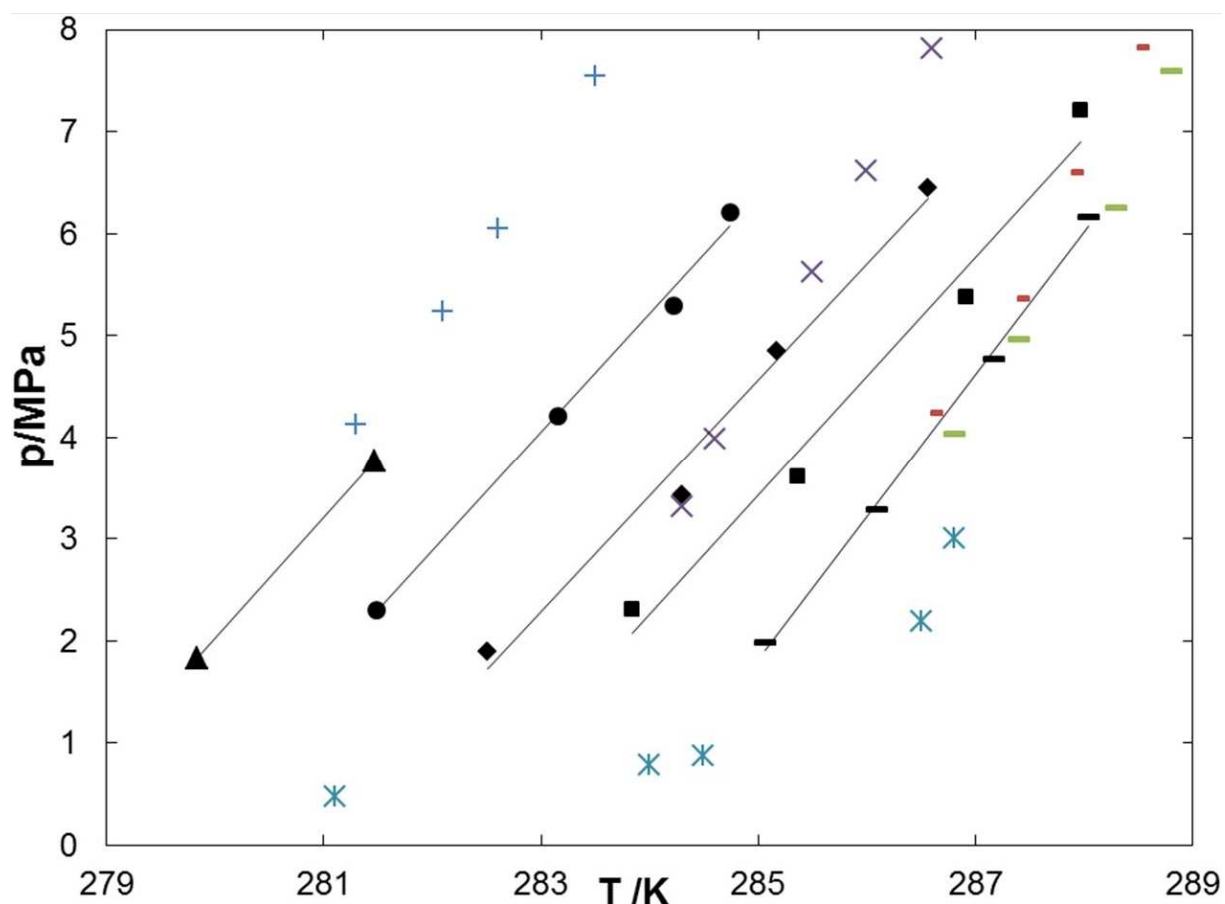

+: (0, 0.29), Lee et al. [31];  
 ▲: (11.24, 0.29), this work;  
 ●: (14.92, 0.29), this work;  
 ◆: (6.87, 0.62), this work;  
 X: (0, 0.62), Mohammadi et al. [27];  
 ■: (14.92, 0.62), this work;  
 -: (0, 1.38), Lee et al. [31];  
 -: (6.87, 1.38), this work;  
 ✱: (0, 1.83), Mohammadi et al. [27].

**Figure 4.** Hydrate equilibrium points for different systems using TBAB as promoter. The figure contains systems of this work and systems of  $N_2$ +TBAB+ $H_2O$  from literature. For clarity reasons, the systems are presented by two numbers in brackets. The first number denotes the mol fraction of  $CO_2$  in  $CO_2$ + $N_2$  gas mixture cylinder and the second one denotes the promoter concentration. Black markers connected with trendlines correspond to results of this work. References are presented according to diagram from left to right.

### 3.2 Results for CP as promoter

Similar procedure was followed for the system  $CO_2$ + $N_2$ +CP+ $H_2O$ . For  $CO_2$ / $N_2$  mixture (6.87/93.13), 15 ml and 25 ml of CP aqueous solution of 20 wt % (6.03 mol %) and 52.57 wt % (22.15 mol %) were prepared respectively. The stoichiometric concentration of CP in the solution for structure II hydrates is 18.65 wt % (5.56 mol %) [35]. For CP concentrations >27.80 wt %, according to Galfré et al. [32], emulsion system is produced. For P-T measurements, stirring velocity is not of importance. We have used relatively high stirring velocity (1070 rpm). It came out that our results were similar for both CP concentrations used. Figure 5 summarizes the results.

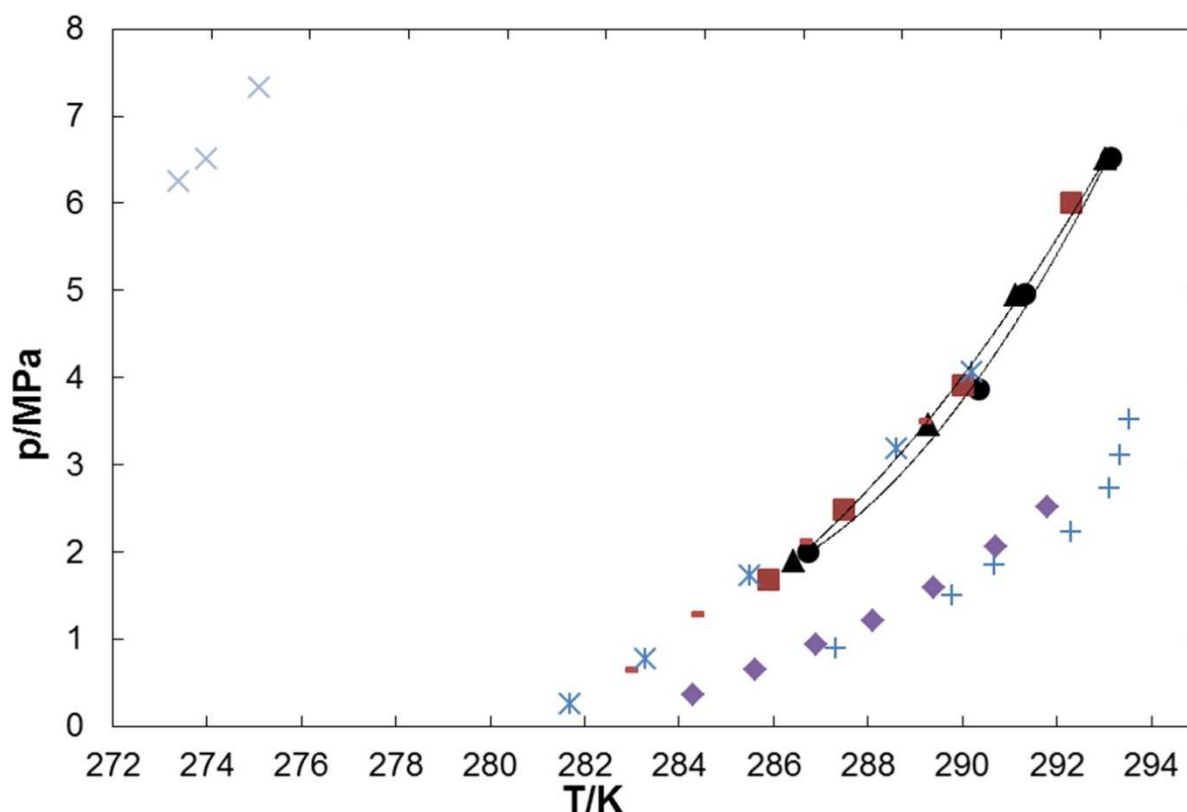

X: (20, 0), Olsen et al. [21];  
 \*: (0, 16.16), Mohammadi and Richon [33];  
 -: (0, 20.42), Tohidi et al. [34];  
 ■: (0, 5.56), Jianwei et al. [35];  
 ▲: (6.87, 22.15), this work;  
 ●: (6.87, 6.03), this work;  
 +: (100, 17.39), Zhang and Lee [19];  
 ◆: (100, 16.16), Mohammadi and Richon [36].

**Figure 5.** Hydrate equilibrium points for different systems using CP promoter. References are presented according to diagram from left to right. The systems of this work are in excellent agreement with systems of pure  $N_2$  indicating that cyclopentane at high concentrations favors  $N_2$  hydrates instead of  $CO_2$  hydrates in  $CO_2+N_2$  gas mixtures. Moreover, the high difference of CP concentrations used in this study is not thermodynamically important and this is shown by the fact that both systems of this study are in very good agreement with each other.

In Figure 5, there is a region in which  $CO_2+N_2$  mixture dissociation points should exist according to experimental results [19, 33, 36]. These are the boundaries of pure  $CO_2$  and pure  $N_2$  with CP+ $H_2O$  systems respectively. Our results are included in these boundaries. Another observation is that CP does not “sense” the small mol fraction of  $CO_2$  (e.g. 6.87 mol %) of  $CO_2$  in  $CO_2+N_2$  gas mixture. In other words, most probably  $N_2$  is predominantly captured –higher  $N_2$  selectivity– rather than  $CO_2$  since the results between pure  $N_2$  and  $CO_2+N_2$  are identical. According to our results, the CP concentration does not have any significant impact on the thermodynamic equilibrium in contrast with TBAB due to water insolubility in cyclopentane. This occurs for both the emulsion and the non emulsion CP case. In other words, the two systems of different CP concentrations match each other excellently.

### 3.3 Results for TBAB+CP as promoter

In Figure 6, three systems of this work for mixture of TBAB+CP and systems from literature (same systems from literature are also presented in Figure 2) for similar conditions, e.g. CO<sub>2</sub> in CO<sub>2</sub>+N<sub>2</sub> and TBAB solution concentrations, are presented. In the caption of Figure 6, along with the two numbers in brackets, there is a third number denoting CP addition in TBAB solution.

The addition of 5 vol % CP in TBAB have shown that for TBAB 1.38 mol %, there is synergetic effect between TBAB and CP which means that the results are better when CP is added compared to pure TBAB. The effect is larger for  $P > 3.5$  MPa as shown in Figure 6. When TBAB 0.62 mol % fraction is used, the results of TBAB and CP proved to be identical with those of pure promoter at same concentration. Finally, for TBAB 0.29 mol % with CP 5 vol %, the gas systems used in this study are different but it is highly improbable that the change in CO<sub>2</sub> concentration would have such a drastical impact on thermodynamic equilibrium that could induce promotion.

About the synergetic effect, one may speculate that s(II) hydrates are formed by the CP and so the 16 small cages of s(II) structure are partly used by semi-clathrates of TBAB to capture CO<sub>2</sub>. The phenomenon is more intense at higher pressures maybe because of higher driving force.

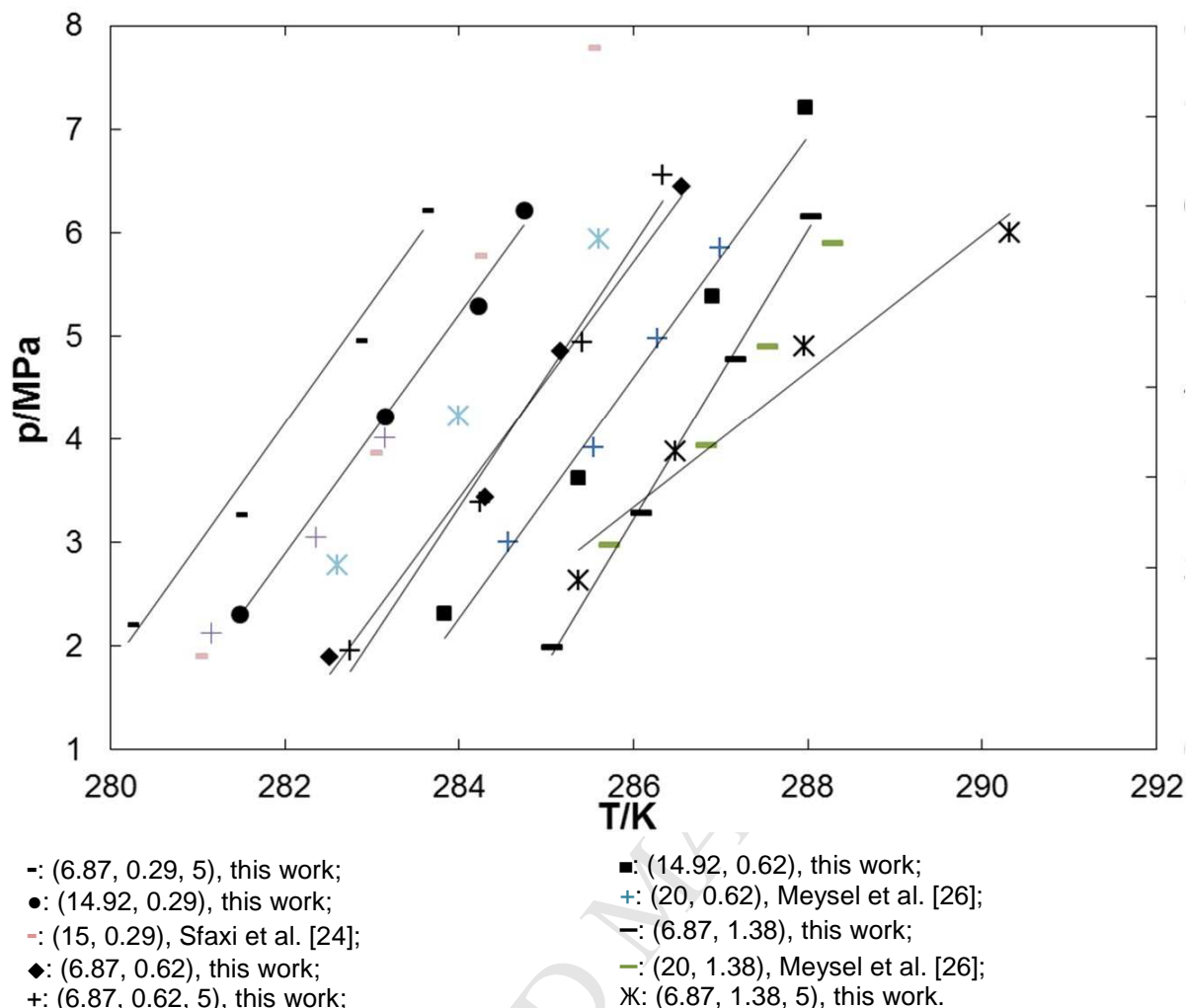

**Figure 6.** Hydrate equilibrium points for different systems using TBAB promoter and mixture of TBAB+CP in this study. References are presented according to diagram from left to right. The first number denotes the mol fraction of CO<sub>2</sub> in CO<sub>2</sub>+N<sub>2</sub> gas mixture cylinder, the second one denotes the promoter concentration and the third number is the 5 vol % of CP used in this work. Black markers connected with trendlines correspond to results of this work. References are presented according to diagram from left to right.

In conclusion, according to our study, it appears that the best combination of promoters seems to be for TBAB 1.38 mol % and 5 vol %. The comparison of TBAB and CP results (Figures 2 and 5) asserts that CP is stronger promoter than TBAB but CP's selectivity for low CO<sub>2</sub> mol fraction is not as good as TBAB's. The results produced in this study will be modeled in the future using suitable models [37], [38].

#### 4 Consistency of experimental results

For data treatment, Clausius –Clapeyron method is applied, eq. 1.

$$\frac{d \ln(P)}{d\left(\frac{1}{T}\right)} = \frac{-\Delta H_{dis}}{Z \cdot R} \quad (1)$$

where  $\Delta H_{dis}$  is the apparent dissociation enthalpy of the hydrate phase,  $Z$  is the compressibility factor and  $R$  is the gas constant. Lee-Kesler-Plöcker (LKP) Equation of State (EoS) [39] is applied for estimation of  $Z$  as a function of  $T$  and  $P$  using binary interaction parameter  $\kappa_{ij}=1.11$ . It is assumed very low solubility and, thus, no changes in the gas composition. The  $\Delta H_{diss.}$  as a function of dissociation temperature shows the goodness of fit. The table 2 presents the data treatment for TBAB results of this work and from literature.

Table 2  
Coefficient of determination of  $\Delta H_{diss.}$  in terms of temperature including TBAB literature

Promoter concentration (mol %)	CO <sub>2</sub> in CO <sub>2</sub> +N <sub>2</sub> gas mixture concentration (mol %)	Coefficient of determination (R <sup>2</sup> )	Literature
<u>TBAB+CP</u>			
0.29	6.87	1.000	this work
0.62	6.87	0.999	this work
1.38	6.87	0.822	this work
<u>TBAB</u>			
0.29	14.92	0.988	this work
0.62	6.87	0.979	this work
0.62	14.92	0.997	this work
1.38	6.87	0.990	this work
0.00	20.0	0.993	Olsen et al. [21]
0.29	20.0	0.952	Meysel et al. [26]
0.62	20.0	0.996	Meysel et al. [26]
1.38	20.0	0.993	Meysel et al. [26]
0.29	15.9	0.961	Lu et al. [22]
1.00	15.9	0.994	Lu et al. [22]
2.90	15.9	0.996	Lu et al. [22]
3.70	15.9	0.998	Lu et al. [22]
4.50	15.9	1.000	Lu et al. [22]
0.29	15.0	0.997	Sfazi et al. [24]
0.55	15.0	0.996	Sfazi et al. [24]
0.55	30.0	0.996	Sfazi et al. [24]
0.29	15.1	0.608	Mohammadi et al. [23]
0.98	15.1	0.707	Mohammadi et al. [23]
2.34	15.1	0.812	Mohammadi et al. [23]
0.29	39.9	0.899	Mohammadi et al. [23]
0.98	39.9	0.972	Mohammadi et al. [23]
2.34	39.9	0.981	Mohammadi et al. [23]



The results of this work are very good ( $R^2 > 0.90$ ) except for the systems of 1.38 mol % of TBAB+CP mixture. Mohammadi et al. [23] shows relative high deviations in many of their systems. The rest systems from literature are very good.

Table 3 presents the data treatment for CP results of this work and from literature. The results of Jianwei et al. [35] and Zhang and Lee [19] are not as accurate as the rest.

Table 3  
Coefficient of determination of  $\Delta H_{diss}$  in terms of temperature for systems with CP hydrates

CP concentration (mol %)	CO <sub>2</sub> in CO <sub>2</sub> +N <sub>2</sub> gas mixture concentration (mol %)	Coefficient of determination ( $R^2$ )	Literature
6.03	6.87	0.983	this work
22.15	6.87	0.977	this work
16.16	100	0.980	Mohammadi and Richon [36]
17.39	100	0.886	Zhang and Lee [19]
16.16	0.0	0.962	Mohammadi and Richon [33]
20.42	0.0	0.975	Tohidi et al. [34]
5.56	0.0	0.703	Jianwei et al. [35]

Finally, the results from systems of CO<sub>2</sub>+TBAB and N<sub>2</sub>+TBAB from literature are presented in table 4. The results for CO<sub>2</sub>+TBAB systems are very good. Almost all N<sub>2</sub>+TBAB systems are suspicious ( $R^2 < 0.90$ ).

Table 4  
Coefficient of determination of  $\Delta H_{diss}$  in terms of temperature for CO<sub>2</sub>+TBAB and N<sub>2</sub>+TBAB systems

TBAB concentration (mol %)	CO <sub>2</sub> in CO <sub>2</sub> +N <sub>2</sub> gas mixture concentration (mol %)	Coefficient of determination ( $R^2$ )	Literature
0.34	100	0.911	Mohammadi et al. [27]
0.69	100	0.943	Mohammadi et al. [27]
1.29	100	0.941	Mohammadi et al. [27]
2.13	100	0.992	Mohammadi et al. [27]
6.89	100	0.929	Mohammadi et al. [27]
0.29	100	0.917	Ye and Zhang [29]
0.62	100	0.880	Ye and Zhang [29]
1.29	100	0.882	Ye and Zhang [29]
6.39	100	0.929	Ye and Zhang [29]
0.29	0.0	0.759	Mohammadi et al. [27]
0.62	0.0	0.558	Mohammadi et al. [27]
1.83	0.0	0.809	Mohammadi et al. [27]
5.29	0.0	0.662	Mohammadi et al. [27]
0.29	0.0	0.624	Lee et al. [31]
1.38	0.0	0.773	Lee et al. [31]

3.59	0.0	0.725	Lee et al. [31]
7.73	0.0	0.893	Lee et al. [31]

## 5 Experimental Uncertainties

The experimental uncertainties are presented in tables 5, 6, 7 and 8. In table 5, the CO<sub>2</sub>+N<sub>2</sub> gas mixture compositions are presented. The gas mixture standard uncertainties are below 3% except in the 1<sup>st</sup> mixture for CO<sub>2</sub> concentration.

Table 5  
Gas mixture composition standard uncertainties

	Gas mixture composition 1 (mol %)		Gas mixture composition 2 (mol %)		Gas mixture composition 3 (mol %)	
	CO <sub>2</sub>	N <sub>2</sub>	CO <sub>2</sub>	N <sub>2</sub>	CO <sub>2</sub>	N <sub>2</sub>
	14.92	85.08	11.24	88.76	6.87	93.13
CO <sub>2</sub> , N <sub>2</sub> gas mixture uncertainty	$U(y_{CO_2})$ (%)	$U(y_{N_2})$ (%)	$U(y_{CO_2})$ (%)	$U(y_{N_2})$ (%)	$U(y_{CO_2})$ (%)	$U(y_{N_2})$ (%)
	5.95	1.24	2.24	0.73	2.57	0.71

The uncertainties of the experimental setup and measurements are estimated. In tables 6 and 7, the absolute temperature and pressure uncertainties  $U(T)$  and  $U(P)$  are presented. The gas mixtures used correspond to gas mixtures as shown in table 5.

Table 6  
Hydrate equilibrium point for CP and TBAB+CP solutions with temperature and pressure uncertainties

Temperature (K)	Pressure (MPa)	CP - wt % (mol %)	Gas mixture composition type	$U(T)$ (K)	$U(P)$ (bar)
286.73	2.00	20 (6.03)	3	0.04	0.07
290.36	3.86	20 (6.03)	3	0.03	0.03
291.32	4.96	20 (6.03)	3	0.02	0.02
293.13	6.53	20 (6.03)	3	0.02	0.02
286.41	1.89	52.57 (22.15)	3	0.02	0.02
289.27	3.45	52.57 (22.15)	3	0.02	0.03
291.14	4.94	52.57 (22.15)	3	0.02	0.02
293.04	6.51	52.57 (22.15)	3	0.02	0.02
TBAB - wt % (mol %) + CP (5 vol %)					
280.20	2.21	5 (0.29)	3	0.04	0.02
281.45	3.27	5 (0.29)	3	0.04	0.03
282.82	4.96	5 (0.29)	3	0.02	0.02
283.59	6.22	5 (0.29)	3	0.04	0.04
282.75	1.95	10 (0.62)	3	0.02	0.02
284.25	3.38	10 (0.62)	3	0.02	0.02
285.41	4.94	10 (0.62)	3	0.03	0.03
286.34	6.55	10 (0.62)	3	0.02	0.02
285.29	1.86	20 (1.38)	3	0.02	0.02

286.39	3.28	20 (1.38)	3	0.03	0.09
287.87	4.46	20 (1.38)	3	0.02	0.06
290.32	5.71	20 (1.38)	3	0.04	0.12

Table 7  
Hydrate equilibrium point for TBAB solution with temperature and pressure uncertainties

Temperature (K)	Pressure (MPa)	TBAB - wt % (mol %)	Gas mixture composition type	$U(T)$ (K)	$U(P)$ (bar)
279.83	1.83	5 (0.29)	2	0.04	0.02
281.47	3.77	5 (0.29)	2	0.06	0.03
281.48	2.31	5 (0.29)	1	0.03	0.02
283.15	4.21	5 (0.29)	1	0.04	0.02
284.21	5.30	5 (0.29)	1	0.02	0.02
284.74	6.21	5 (0.29)	1	0.03	0.02
282.51	1.89	10 (0.62)	3	0.03	0.02
284.30	3.42	10 (0.62)	3	0.04	0.02
285.17	4.84	10 (0.62)	3	0.03	0.02
286.56	6.45	10 (0.62)	3	0.02	0.02
283.83	2.31	10 (0.62)	1	0.03	0.02
285.37	3.61	10 (0.62)	1	0.02	0.02
286.91	5.38	10 (0.62)	1	0.02	0.03
287.97	7.21	10 (0.62)	1	0.02	0.02
285.06	1.98	20 (1.38)	3	0.02	0.02
286.09	3.28	20 (1.38)	3	0.02	0.02
287.18	4.77	20 (1.38)	3	0.02	0.05
288.04	6.16	20 (1.38)	3	0.02	0.03

The  $U(T)$  and  $U(P)$  are both, on average, 0.03 K and 0.03 bar respectively. The uncertainties are very low and, hence, quite satisfactory.

In table 8, the gas standard uncertainties of mol inserted in equilibrium cell,  $U(n_{gas})$ , and of the quantities of gases and solution compounds are shown. The average value of standard uncertainty is 2.25%.

Table 8  
Gas molar composition and gas inserted uncertainty  $U(n_{gas})$  for every hydrate equilibrium point

CO <sub>2</sub> inserted (mol)	N <sub>2</sub> inserted (mol)	H <sub>2</sub> O inserted (mol)	Promoter inserted (mol)	$U(n_{gas})$ (%)	Gas mixture composition type	Promoter concentration (mol %)
0.00773	0.0692	1.31	0.00403	1.9	1	0.29 TBAB
0.00698	0.0626	1.31	0.00403	2.0	1	0.29 TBAB
0.01673	0.1499	1.31	0.00403	1.7	1	0.29 TBAB
0.00861	0.0771	1.31	0.00403	1.9	1	0.29 TBAB
0.00873	0.0782	1.24	0.00806	1.9	1	0.62 TBAB
0.00778	0.0697	1.24	0.00806	1.9	1	0.62 TBAB
0.01095	0.0981	1.24	0.00806	2.0	1	0.62 TBAB
0.00660	0.0591	1.24	0.00806	2.0	1	0.62 TBAB
0.00604	0.0749	1.31	0.00403	1.9	2	0.29 TBAB
0.00942	0.1169	1.31	0.00403	1.9	2	0.29 TBAB
0.00484	0.1031	1.24	0.00806	1.7	3	0.62 TBAB

0.00589	0.1255	1.24	0.00806	1.7	3	0.62	TBAB
0.00509	0.1084	1.24	0.00806	1.8	3	0.62	TBAB
0.00523	0.1114	1.24	0.00806	1.8	3	0.62	TBAB
0.00643	0.1371	0.51	0.06507	1.7	3	22.15	CP
0.00451	0.0960	0.51	0.06507	1.9	3	22.15	CP
0.00434	0.0926	0.51	0.06507	1.8	3	22.15	CP
0.00447	0.0954	0.51	0.06507	1.9	3	22.15	CP
0.00757	0.1613	1.19	0.05667	2.3	3	6.03	CP
0.00431	0.0918	1.19	0.05667	2.2	3	6.03	CP
0.00330	0.0703	1.19	0.05667	1.9	3	6.03	CP
0.00492	0.1048	1.19	0.05667	1.8	3	6.03	CP
0.00482	0.1028	1.64	0.03002	1.8	3	0.62	TBAB+CP (5 vol %)
0.00457	0.0973	1.64	0.03002	1.8	3	0.62	TBAB+CP (5 vol %)
0.00338	0.0721	1.64	0.03002	2.2	3	0.62	TBAB+CP (5 vol %)
0.00467	0.0996	1.64	0.03002	1.8	3	0.62	TBAB+CP (5 vol %)
0.00445	0.0948	2.19	0.03065	1.9	3	0.29	TBAB+CP (5 vol %)
0.00221	0.0471	2.19	0.03065	3.0	3	0.29	TBAB+CP (5 vol %)
0.00384	0.0819	2.19	0.03065	1.9	3	0.29	TBAB+CP (5 vol %)
0.00332	0.0707	2.19	0.03065	2.5	3	0.29	TBAB+CP (5 vol %)
0.00265	0.0565	1.77	0.02578	2.1	3	1.38	TBAB
0.00351	0.0747	1.77	0.02578	1.9	3	1.38	TBAB
0.00419	0.0894	1.77	0.02578	2.7	3	1.38	TBAB
0.00392	0.0834	1.77	0.02578	2.1	3	1.38	TBAB
0.00246	0.0525	1.24	0.03540	2.1	3	1.38	TBAB+CP (5 vol %)
0.00280	0.0596	1.24	0.03540	6.0	3	1.38	TBAB+CP (5 vol %)
0.00297	0.0633	1.24	0.03540	4.0	3	1.38	TBAB+CP (5 vol %)
0.00353	0.0752	1.24	0.03540	6.1	3	1.38	TBAB+CP (5 vol %)

## 4 Conclusions

Hydrate equilibrium points for CO<sub>2</sub> and N<sub>2</sub> were measured with the use of tetra-n-butylammonium bromide (TBAB), cyclopentane (CP) and mixtures of TBAB with CP as promoters. The use of higher TBAB concentration (1.38 mol %) and CP (5 vol %) revealed promotion effect and also as the pressure increases (>3.5 MPa), the promotion effect increases. In addition, the higher the CO<sub>2</sub> concentration, the stronger the promotion is for every TBAB solution which is shown by the shift of equilibrium points at higher temperatures. On the contrary, the results have shown that the simultaneous use of TBAB (0.29 mol %) and (0.62 mol %) with CP (5 vol %) did not have any impact on thermodynamic equilibrium. For the system TBAB (0.29 mol %) with CP (5 vol %), even though the gas mixture systems are different, it is rather unlikely that there is positive impact in promotion. However, this fact is not easily observable for low differences of CO<sub>2</sub> concentration in gas mixtures with N<sub>2</sub>. Consequently, it came out that the factor of gas mixture concentration has moderate impact on hydrate equilibrium points compared to promoter's concentration.

The use of CP solution (even though it is virtually water insoluble) proved to be stronger promoter than TBAB maybe because of the different hydrate structure it induces. The CP drawback, however, is the low CO<sub>2</sub> selectivity in gas hydrate in CO<sub>2</sub>+N<sub>2</sub> gas mixture. The stoichiometric concentration of CP in the solution for structure II hydrates is 18.65 wt % (5.56 mol %). When higher CP concentration than this value was used, e.g. 52 wt % (22.15 mol %), the results showed slight inhibition effect. Finally, the data consistency analysis carried out using Clausius-Clapeyron method revealed that measurements of this work are satisfactory.

## Acknowledgements

The hydrate equilibrium data were measured at the Centre Thermodynamic of Processes of MINES ParisTech (France) as part of a collaborative project funded by the Danish Technical Research Council (FTP project: CO<sub>2</sub> hydrates — Challenges and possibilities). The authors wish to thank Ing. Alain Valtz for his technical assistance and fruitful discussion.

## List of Abbreviations

$k$	coverage factor
CP	cyclopentane
$n$	mol of gas inserted in equilibrium cell
$P$	hydrate equilibrium pressure
$T$	hydrate equilibrium temperature
TBAB	tetra-n-butyl ammonium bromide
$u(T)$	temperature error
$u(P)$	pressure error
$U(T)$	standard temperature uncertainty
$U(P)$	standard pressure uncertainty
$U(y)$	standard uncertainty of gas in gas mixture cylinder
$U(n)$	standard uncertainty of gas molar composition in equilibrium cell
$u_{cal.}(y)$	calibration error of gas in gas mixture cylinder
$y$	gas molar fraction
$\Delta H$	apparent dissociation enthalpy

## Greek letter

k binary interaction parameter

### Subscripts

cal. calibration  
 ij components i and j  
 diss. dissociation

## References

- [1] P.H.M. Feron, C.A. Hendriks, *Oil Gas Sci. Techn.* 60 (2005) 451–459.
- [2] J.C.M. Pires, F.G. Martins, M.C.M. Alvim-Ferraz, M. Simoes, *Chem. Eng. Res. Des.* 89 (2011) 1446–1460.
- [3] N.H. Duc, F. Chauvy, J.M. Herri, *Energy Convers. Manage.* 48 (2007) 1313–1322.
- [4] P. Babu, W.I. Chin, R. Kumar, P. Linga, *Ind. Eng. Chem. Res.* 53 (2014) 4878–4887.
- [5] H. Bruusgaard, J.G. Beltrán, P. Servio, *J. Chem. Eng. Data* 53 (2008) 2594–2597.
- [6] H. Tajima, A. Yamasaki, F. Kiyono, *Energy* 29 (2004) 1713–1729.
- [7] T. Kuramochi, A. Ramírez, W. Turkenburg, A. Faaij, *Energy Procedia* 4 (2011) 1981–1988.
- [8] A. Eslamimanesh, A.H. Mohammadi, D. Richon, P. Naidoo, D. Ramjugernath, *J. Chem. Therm.* 46 (2012) 62–71.
- [9] K. Tumba, P. Reddy, P. Naidoo, D. Ramjugernath, A. Eslamimanesh, A.H. Mohammadi, D. Richon, *J. Chem. Eng. Data* 56 (2011) 3620–3629.
- [10] J. Zhang, J.W. Lee, *Ind. Eng. Chem. Res.* 48 (2009) 5934–5942.
- [11] P.J. Herslund, K. Thomsen, J. Abildskov, N. von Solms, A. Galfré, P. Brântuas, M. Kwaterski, J.M. Herri, *Int. J. of Greenhouse Gas Control* 17 (2013) 397–410.
- [12] P.J. Herslund, N. Daraboina, K. Thomsen, J. Abildskov, N. von Solms, *Fluid Phase Equilib.* 381 (2014) 20–27.
- [13] P. Linga, R. Kumar, P. Englezos, *J. Hazard. Mater.* 149 (2007) 625–629.
- [14] X.S. Li, Z.M. Xia, Z.Y. Chen, K.F. Yan, G. Li, H.J. Wu, *Ind. Eng. Chem. Res.* 49 (2010) 11614–11619.
- [15] W. Lin, D. Dalmazzone, W. Fürst, A. Delahaye, L. Fournaison, P. Clain, *J. Chem. Eng. Data* 58 (2013) 2233–2239.
- [16] A. Fukumoto, P. Paricaud, D. Dalmazzone, W. Bouchafaa, T.S. Ho, W. Fürst, *J. Chem. Eng. Data* 59 (2014) 3193–3204.
- [17] S. Li, S. Fan, J. Wang, X. Lang, Y. Wang, *Chin. J. Chem. Eng.* 18 (2010) 202–206.
- [18] S. Lee, S. Park, Y. Lee, J. Lee, H. Lee, Y. Seo, *Langmuir* 27 (2011) 10597–10603.

- [19] J. Zhang, J.W. Lee, *J. Chem. Eng. Data* 54 (2009) 659–661.
- [20] R. Ohmura, S. Takeya, T. Uchida, T. Ebinuma, *Ind. Eng. Chem. Res.* 43 (2004) 4964–4966.
- [21] M.B. Olsen, A. Majumdar, P.R. Bishnoi, *Int. J. The Soc. of Mat. Eng. For Res.* 7 (1999) 17–23.
- [22] T. Lu, Y. Zhang, X.S. Li, Z.Y. Chen, K.F. Yan, *Guocheng Gongcheng Xuebao/The Chin. J. of Process Eng.* 9 (2009) 541–544.
- [23] A.H. Mohammadi, A. Eslamimanesh, V. Belandria, D. Richon, P. Naidoo, D. Ramjugernath, *J. Chem. Thermodyn.* 46 (2012) 57–61.
- [24] I. Sfaxi, I. Durand, R. Lugo, A. Mohammadi, D. Richon, *Int. J. of Greenhouse Gas Control* 26 (2014) 185–192.
- [25] C. Chen, X.S. Li, Z.Y. Chen, Z.M. Xia, K.F. Yan, J. Cai *J. Chem. Eng. Data* 59 (2014) 103–109.
- [26] P. Meysel, L. Oellrich, P.R. Bishnoi, M.A. Clarke, *J. Chem. Thermodyn.* 43 (2011) 1475–1479.
- [27] A.H. Mohammadi, A. Eslamimanesh, V. Belandria, D. Richon, *J. Chem. Eng. Data* 56 (2011) 3855–3865.
- [28] N.A. Sami, K. Das, J.S. Sangwai, N. Balasubramanian, *J. Chem. Thermodyn.* 65 (2013) 198–203
- [29] N. Ye, P. Zhang, *J. Chem. Eng. Data* 57 (2012) 1557–1562.
- [30] S. Lee, S. Park, Y. Lee, J. Lee, H. Lee, Y. Seo, *Langmuir* 27 (2011) 10597–10603.
- [31] S. Lee, Y. Lee, S. Park, Y. Seo, *J. Chem. Eng. Data* 55 (2010) 5883–5886.
- [32] A. Galfré, M. Kwaterski, P. Brântuas, A. Cameirao, J.M. Herri, *J. Chem. Eng. Data* 59 (2014) 592–602.
- [33] A.H. Mohammadi, D. Richon, *Chem. Eng. Sci.* 66 (2011) 4936–4940.
- [34] B. Tohidi, A. Danesh, A.C. Todd, R.W. Burgass, K.K. Østergaard, *Fluid Phase Equilib.* 138 (1997) 241–250.
- [35] D. Jianwei, L. Deqing, L. Dongliang, L. Xinjun, *Ind. Eng. Chem. Res.* 49 (2010) 11797–11800.
- [36] A.H. Mohammadi, D. Richon, *Chem. Eng. Sci.* 64 (2009) 5319–5322.
- [37] G.M. Kontogeorgis, E.C. Voutsas, I.V. Yakoumis, D.P. Tassios, *Ind. Eng. Chem. Res.* 35 (1996) 4310–4318.
- [38] P. Paricaud, *J. Phys. Chem. B* 115 (2010) 288–299.
- [39] U. Pliicker, H. Knapp, J.M. Prausnitz, *Int. Chem. Proc.* 17 (1978) 324–334.