



**HAL**  
open science

## **Geostatistics for Geotechnicians**

Serge Antoine Séguret

► **To cite this version:**

| Serge Antoine Séguret. Geostatistics for Geotechnicians. Doctoral. Chile. 2014. <hal-01084930>

**HAL Id: hal-01084930**

**<https://minesparis-psl.hal.science/hal-01084930v1>**

Submitted on 11 Jul 2019

**HAL** is a multi-disciplinary open access archive for the deposit and dissemination of scientific research documents, whether they are published or not. The documents may come from teaching and research institutions in France or abroad, or from public or private research centers.

L'archive ouverte pluridisciplinaire **HAL**, est destinée au dépôt et à la diffusion de documents scientifiques de niveau recherche, publiés ou non, émanant des établissements d'enseignement et de recherche français ou étrangers, des laboratoires publics ou privés.



HAL Authorization

# **Geostatistics for Geotechnicians (Geostadística para Geotécnicos)**

**Key notes, paper, Fracture  
Frequency tutorial (Notas claves,  
publicación, Frecuencia de  
fracturas, Tutorial del caso de  
estudio)**

**Serge Antoine Séguret**

November 2014  
N° R141130SSEG

Mines ParisTech  
Centre of Geosciences and Geoengineering  
35 rue Saint Honoré  
77305 Fontainebleau - France

<b>Introducción</b>	<b>1</b>
<b>Introduction</b>	<b>2</b>
<b>Key Notes</b>	<b>3</b>
<b>Fracture frequency case study tutorial page</b>	<b>60</b>
<b>Caving 2014 paper</b>	<b>69</b>

## Introducción

Este documento es el soporte de un curso dado en Calama, Chile, desde el 24 al 28 de Noviembre 2014. Concerniente a los asistentes: todo profesional involucrado en Geotecnia, que nunca haya estudiado Geoestadística, pero que la usarán como una herramienta en el futuro próximo.

Esta es la razón por la cual la parte de geostatística de este curso sólo tiene como objetivo presentar las bases geoestadísticas - variograma, kriging -, lo suficiente como para llevar a cabo un estudio original de la Frecuencia de Fracturas (FF). Este estudio ha sido presentado durante el último congreso Caving celebrado en Chile en Junio de 2014, cuya publicación se incluye al final del documento.

El curso se divide en dos partes: la teoría por un lado, y por otro lado la aplicación utilizando el programa Isatis, amablemente ofrecido sin costo por la empresa Geovariances (licencia de un mes de duración). La aplicación tiene como objetivo reproducir el estudio descrito en la publicación.

La parte del curso propio de la Geotecnia es el capítulo C titulado " Geotechnics specificity" (Especificaciones Geotécnicas) en el cual se detalla la frecuente problemática encontrada en Geotecnia, que atemoriza tanto a los técnicos como a los geoestadísticos: la falta de aditividad de la mayoría de las variables regionalizadas encontradas en Geotecnia; la direccionalidad de ciertas medidas (por ejemplo, la dirección del sondaje de la muestra influencia la medida así como la permeabilidad; y finalmente, el problema de cambio de escala, el cual puede no ser lineal, pero no solamente eso: el concepto de la extensión, de una muestra a un bloque, que una propiedad dada tiene y que en algún momento no tiene sentido por sí misma. Por ejemplo, ¿qué interpretación podemos darle al IRS (Intact Rock Strength) a la escala del bloque deducido a partir de muestras, sabiendo que la medida en la muestra se realiza a mano utilizando un martillo? Debemos imaginar un gigante con un martillo gigante que golpea con violencia un bloque tan grande como la oficina donde escribo la presente introducción?

La pregunta está abierta, así como para el PLT (Point Loading Test). En el curso sólo detallaremos el trabajo realizado en FF y RQD ( Rock Quality Design).

En comparación a la Geología o el Petróleo, no existen tantas aplicaciones de Geoestadística en el área de la Geotechnia debido a las razones mencionadas anteriores, pero mis personales tres años de trabajo a tiempo parcial en este dominio, me lleva a la siguiente conclusión: si manejamos correctamente las anteriores dificultades inusuales mencionadas, la física subyacente del fenómeno es tan fuerte que algunas propiedades increíbles emergen desde las estadísticas, increíbles en el sentido que son conmensuradas con el tamaño de las dificultades superadas, lo que lleva a conceptos muy originales como Concentración Direccional, Coeficientes de Correlación Regionalizados y Fracturas Independientes , conceptos que están desafortunadamente fuera del marco limitado de este curso.



# Geostatistics for Geotechnicians

## Introduction

This document is the support of a course done in Calama, Chile, from November 24<sup>th</sup> to 28<sup>th</sup> 2014. It concerns ab initio attendees, all professional in Geotechnique, who never study Geostatistics, but are going to use it in a next future.

This is the reason why the geostatistical part of the course just aims at presenting the geostatistical bases - variogram, kriging -, enough to conduct an original study of Fracture Frequency (FF). This study has been presented during the last Caving congress held in Chile in June 2014 and the paper is included at the end of the document.

The course is separated in two parts, theory in one hand, and application by using the Isatis software kindly given for free by Geovariances company (one month duration license). The application aims at reproducing the study described in the paper.

The part of the course proper to Geotechnique is the chapter C entitled “Geotechnics specificity” where we detail the problematic often encountered in Geotechnics that afraid so much the technicians and the geostatisticians: the lack of additivity of most of the regionalized variable encountered in Geotechnique; the directionality of some types of measures (i.e. the sample direction influences the measure like for the permeability); and finally, the change of scale problem which can be not linear, but not only: the concept of the extension from a sample to a block of a given property has sometime no sense by itself. For example, what interpretation can we give to Intact Rock strength (IRS) at block scale deduced from samples, knowing that the sample measure is done by hand using a hammer? Must we imagine a giant using a gigantic hammer to hit with violence a block as large as the office where I write the present introduction?

The question is open, as well as for Point Loading Test (PLT), and we only detail in the course the work done on FF and Rock Quality Design (RQD).

In comparison with Geology or Petroleum, there are not so many applications of Geostatistics in Geotechnique because of the previous mentioned reasons but my personal three years of partial time work on the domain leads me to this conclusion: if we correctly handle the previous mentioned unusual difficulties, the underlying physic of the phenomenon is so strong that some incredible properties emerges from the statistics, incredible in the sense that they are commensurate with the size of the difficulties surmounted, leading to very original concepts like Directional Concentration, Regionalized Correlation Coefficients and Independent Fractures, concepts that are unfortunately outside the restricted framework of this course.



# Geostatistics for Geotechnicians

Serge Antoine Séguret  
24-28 11 2014

## PLANNING

A - Convenio	2005 - 2015
B - Mining Geostatistics	Where? What? How?
C - Geotechnics specificity	Additivity, directionality, scale change
D - Application	FF (Chuqui data) Caving 2014 paper (Cristian) Isatis

## B - Mining Geostatistics

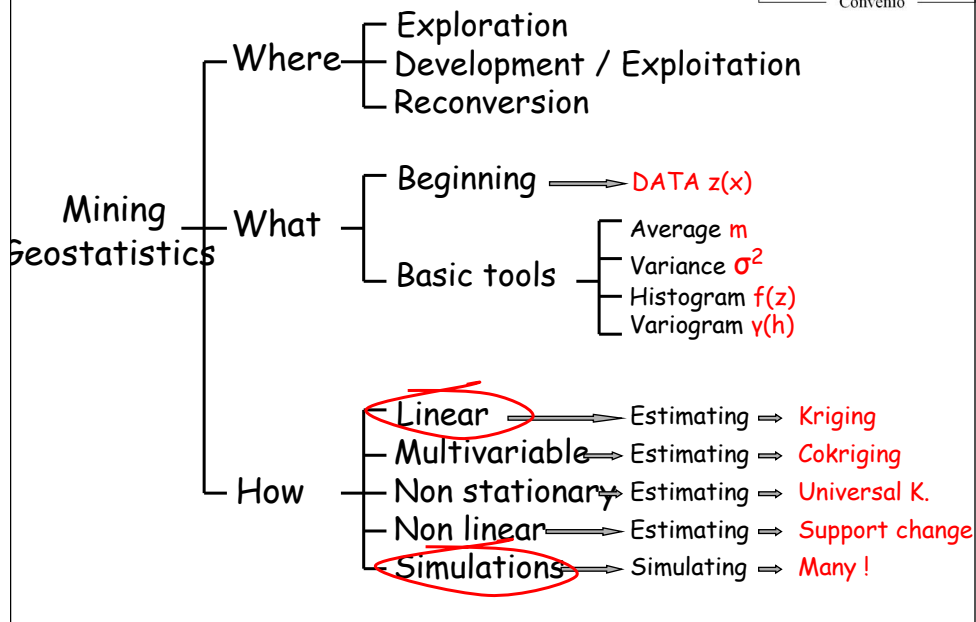

### B - Mining Geostatistics Where?

## Exploration

- Drill holes campaign for recognition

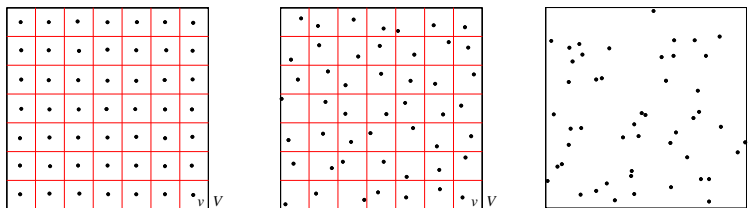

Regular grid ? Mesh ? Anisotropy ?

## Exploration

- Limits of the deposit

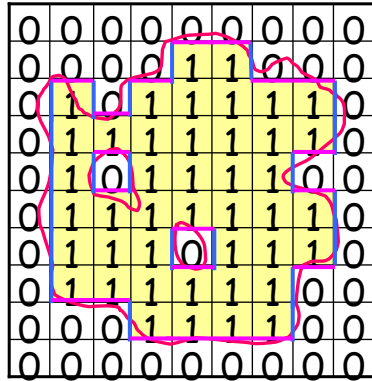

$$\frac{\sigma_A^2}{A} = \frac{1}{43^2} \left[ \frac{9}{6} + 0,061 \frac{11^2}{9} \right]$$

$$\frac{\sigma_A^2}{A^2} = 0,001255$$

$$\frac{\sigma_A}{A} = 0,0354 = 3,54\%$$

- 3D geological model (deterministic)
- Uncertainty of the limits

## Exploration

- Global estimation of the resource

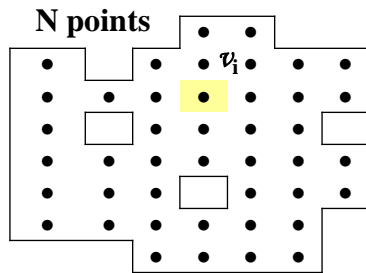

$$Z_G^* - Z_G =$$

$$\frac{1}{N} \sum_i [Z(x_i) - Z_v(x_i)]$$

$$\sigma_G^2 = \text{Var}[Z_G^* - Z_G]$$

- geological cutoff grade
- ore and metal tonnage, average grade
- uncertainty of the results

# Exploration

- Complementary drillholes

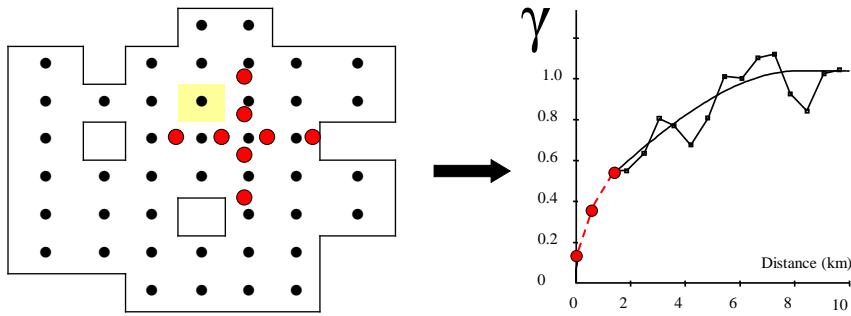

- Interest of a smaller mesh, cross of drillholes

# Exploration

- Prefaisability study (technical & economical)

Drill Pattern (m*m)	Mean Grade (% Cu)	Variance (% Cu)**2	Tonnage (Mton)	NPV (MUSS)
150 by 150	0.551	0.014	801	-49
100 by 100	0.650	0.042	672	345
50 by 50	0.667	0.064	613	389
20 by 10	0.675	0.674	602	421
10 by 5	0.685	0.690	585	450

Profit ? Continue or stop ?

## Development

- Local estimation

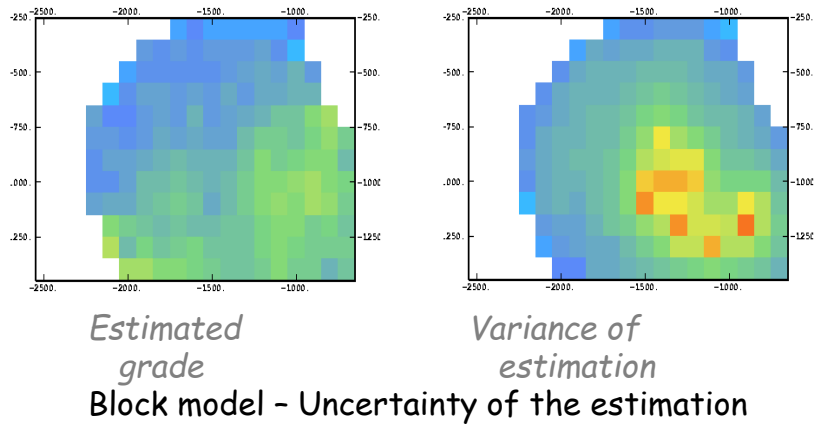

## Development

- Selection, selectivity

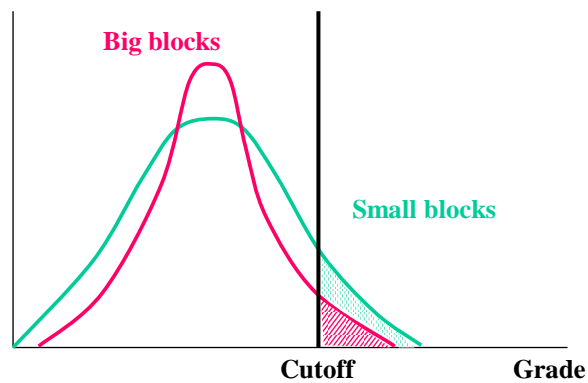

Economical cutoff grade - Selection unit (support effect)

# Development

- Recoverable reserves

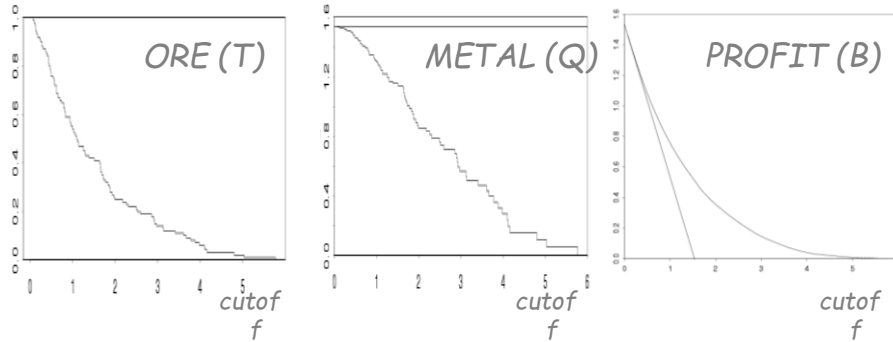

Tonnage-grade curves - Uncertainty

# Development

- Faisability study (technical and economical)

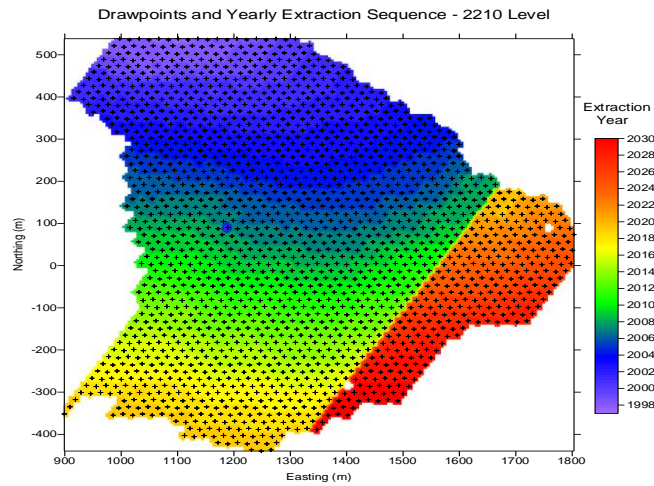

Detailed project - Profit ? Continue or stop ?

# Exploitation

- Size & number of working units

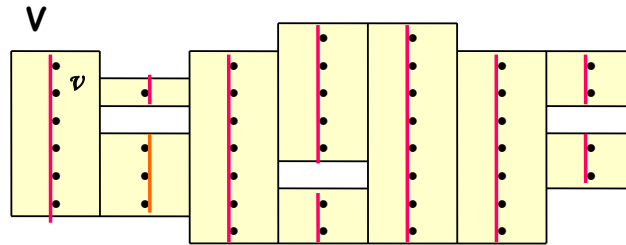

$$\sigma^2(v|V) = \bar{\gamma}(V, V) - \bar{\gamma}(v, v)$$

# Exploitation

- Homogenization stocks

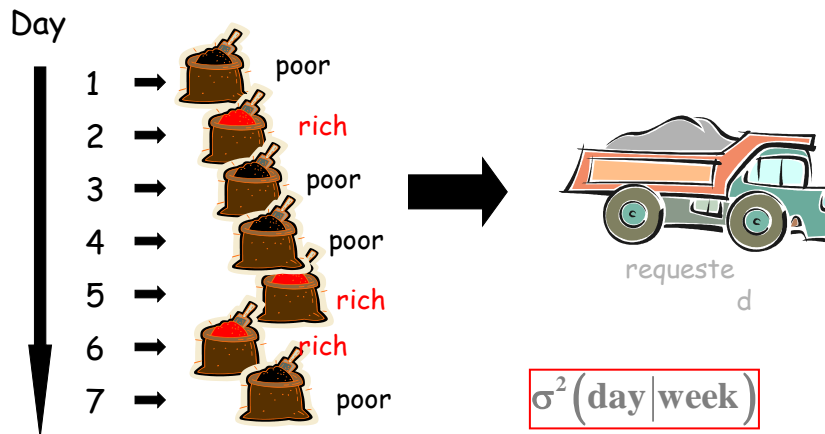

# Exploitation

- Global balance



+

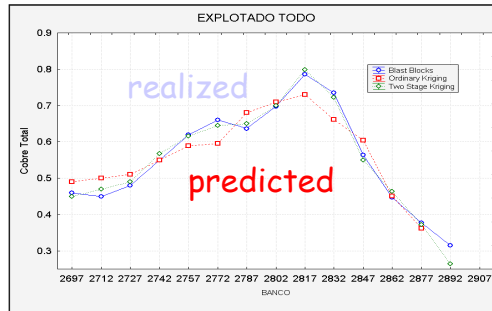
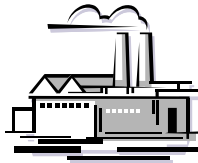

comparison predicted / realized

# Reconversion

Example: ground de-pollution

- measurement campaign
- global estimation of pollution levels
- Local estimation
- overstepping threshold probabilities

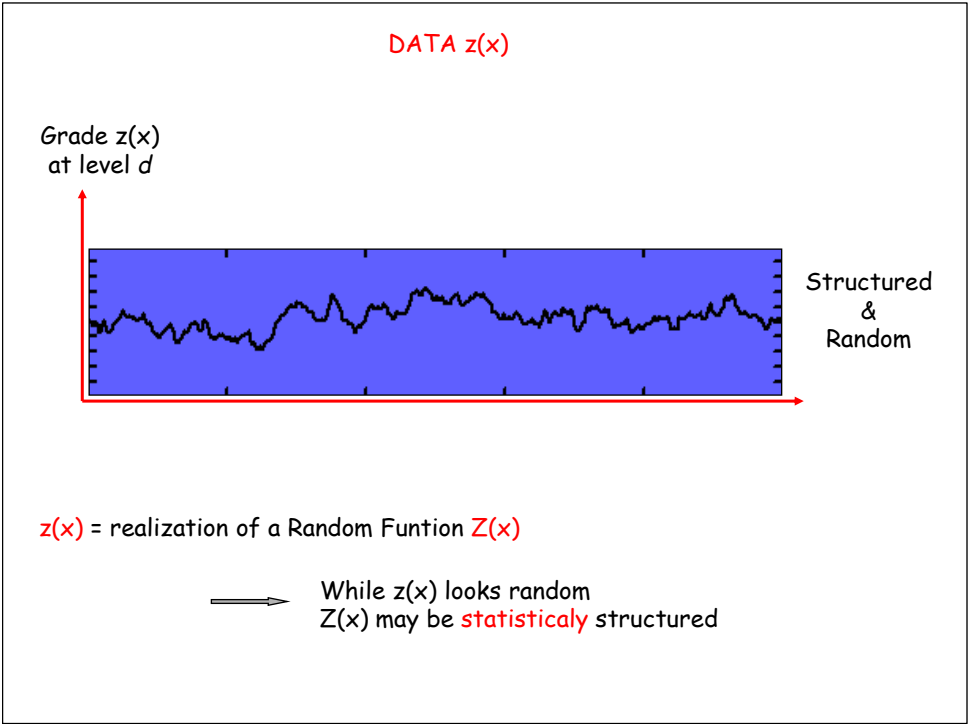
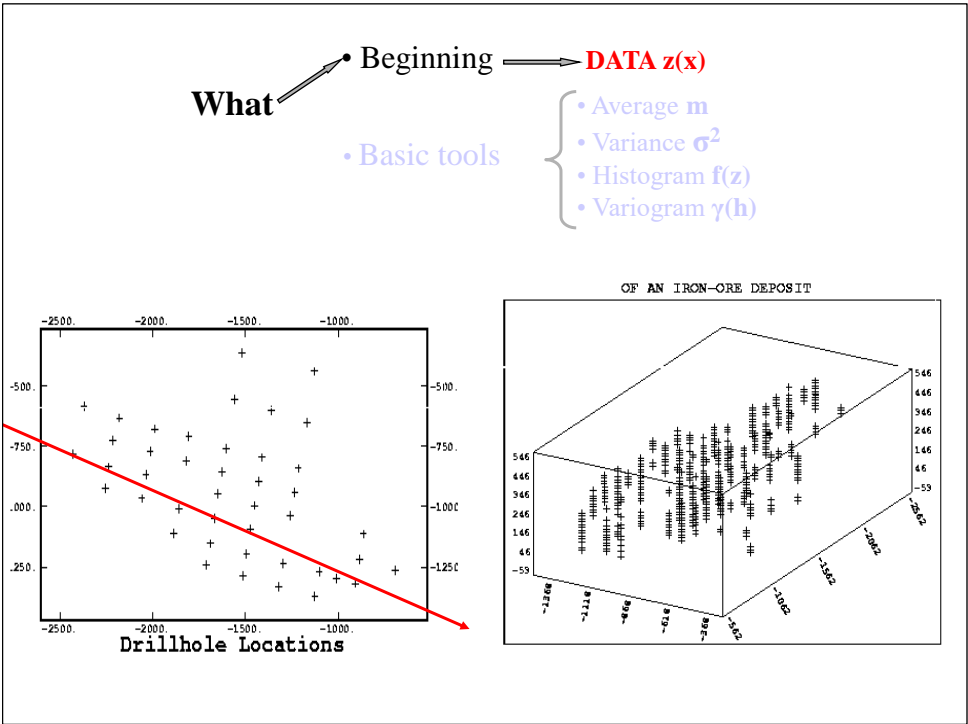

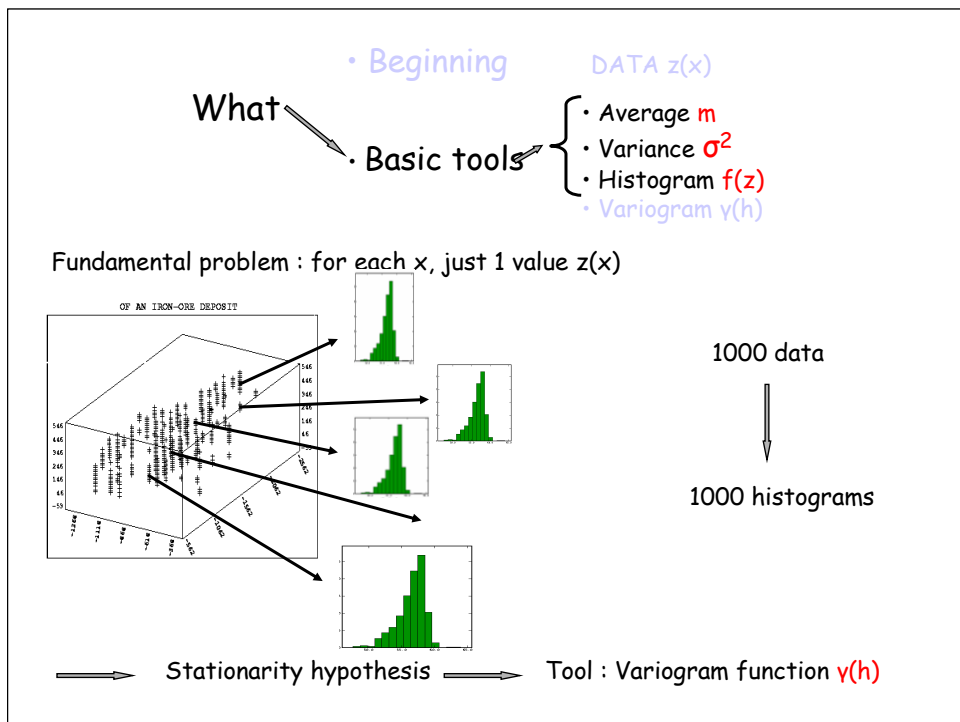
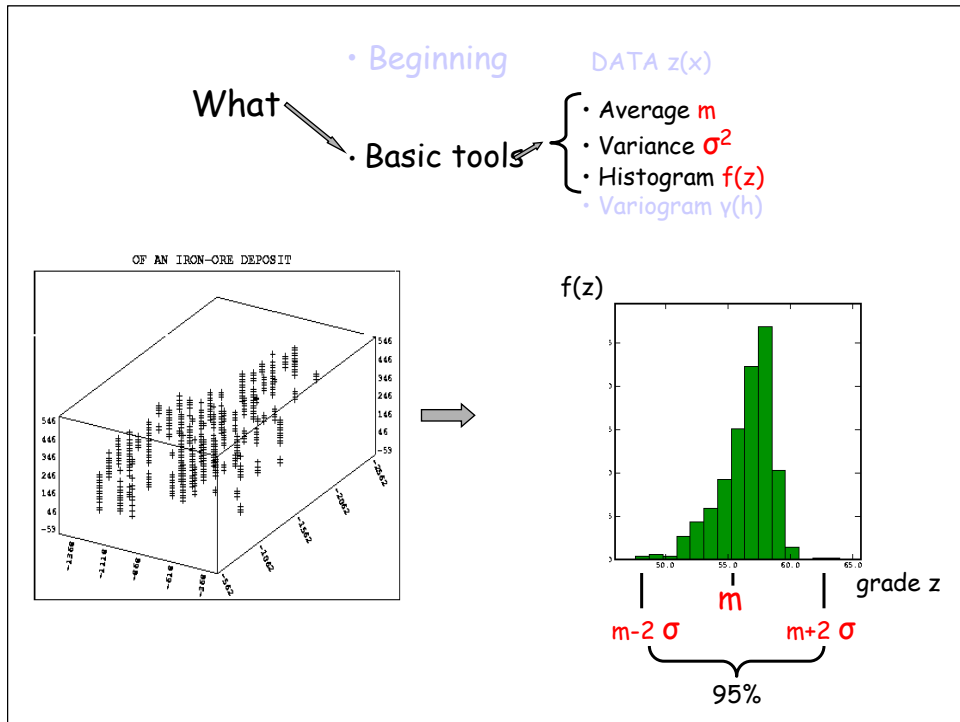

- Beginning
  - Basic tools
- DATA  $z(x)$
- Average  $m$
  - Variance  $\sigma^2$
  - Histogram  $f(z)$
  - Variogram  $\gamma(h)$

### Comparing values

- Take 2 measurements  $z(x_1)$  &  $z(x_2)$
- Calculate  $0.5[z(x_1)-z(x_2)]^2$
- Plot it versus  $h$

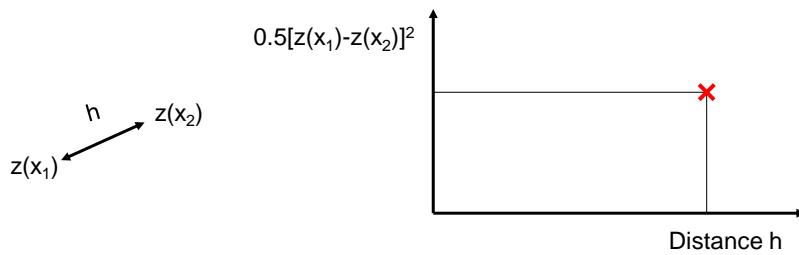

- Reproduce for all  $(z(x_\alpha), z(x_\beta))$

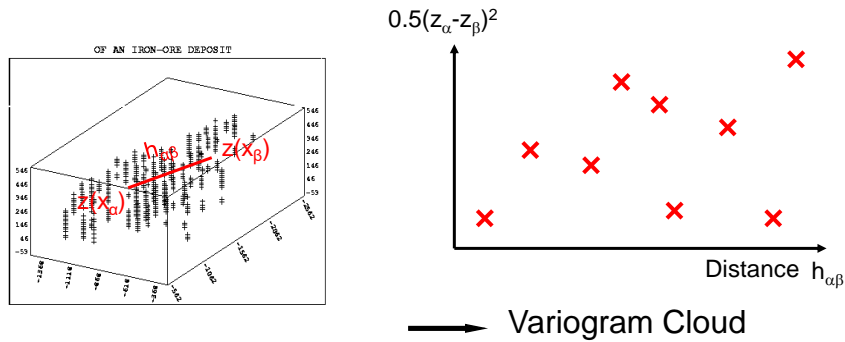

Rapidly unreadable

50 data points → 1225 values

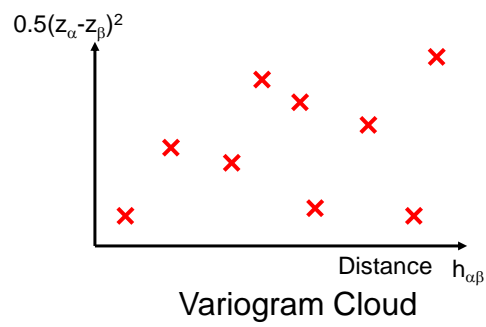

Summary

• Average of values having same  $h_{\alpha\beta}$

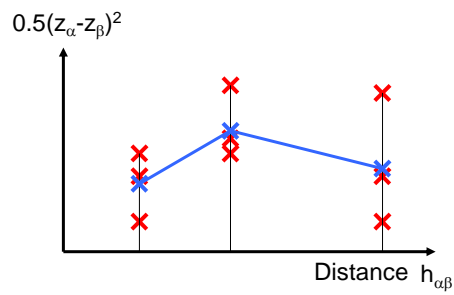

→ Experimental variogram  $\gamma^*(h)$

No many pairs do have same  $h_{\alpha\beta}$

- Regroup by classes
- Calculate center of gravity

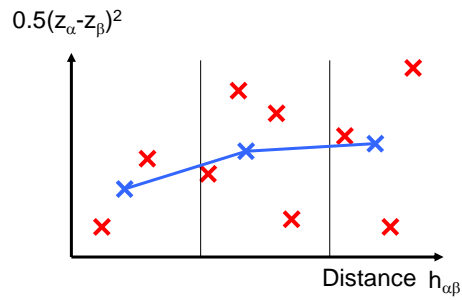

## SUMMARY

Regular grid

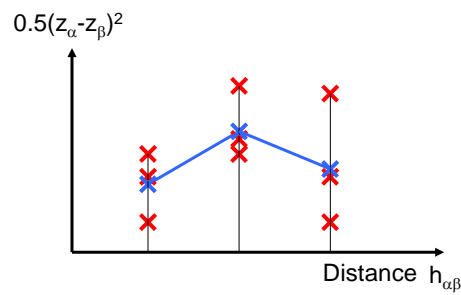

No regular

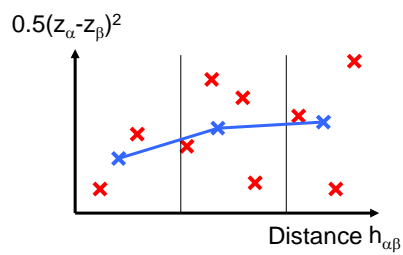

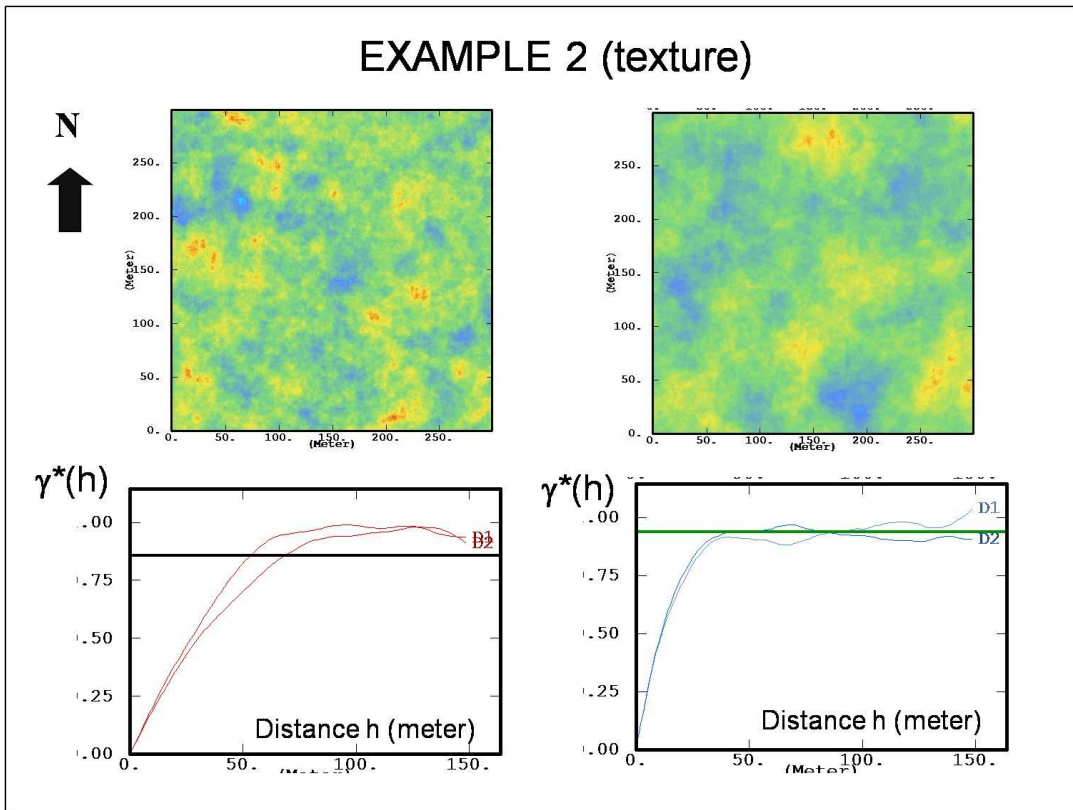
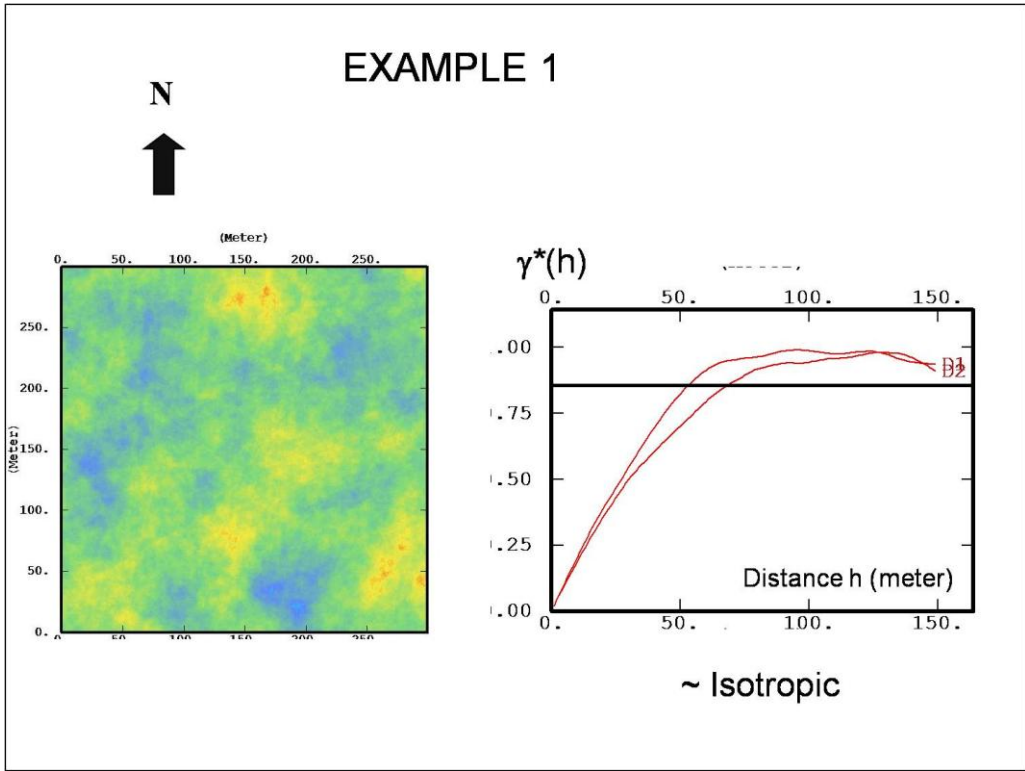

### EXAMPLE 3 (anistotropy)

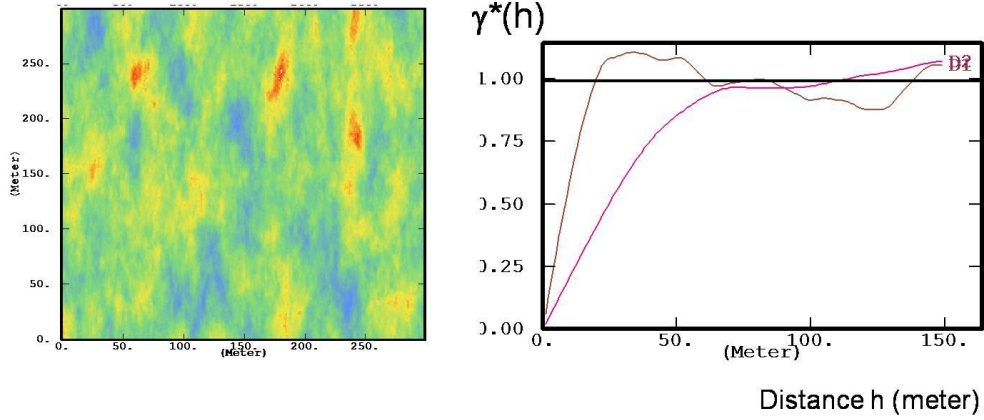

### EXAMPLE 4

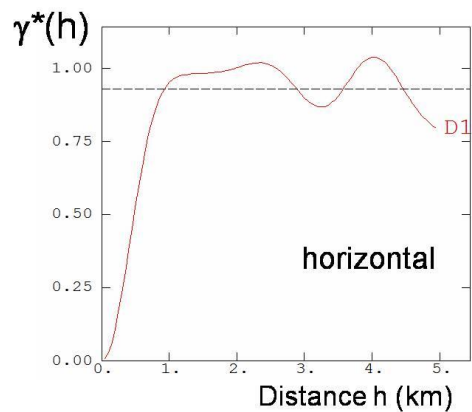
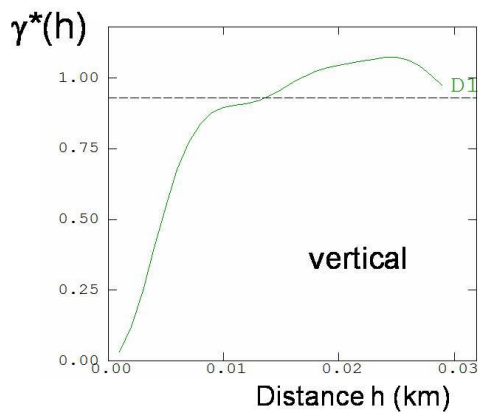
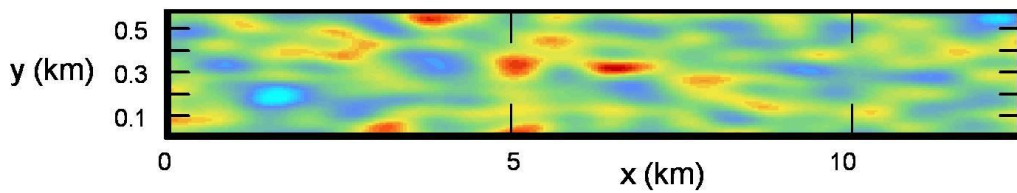

## EXAMPLE 5 (Drift)

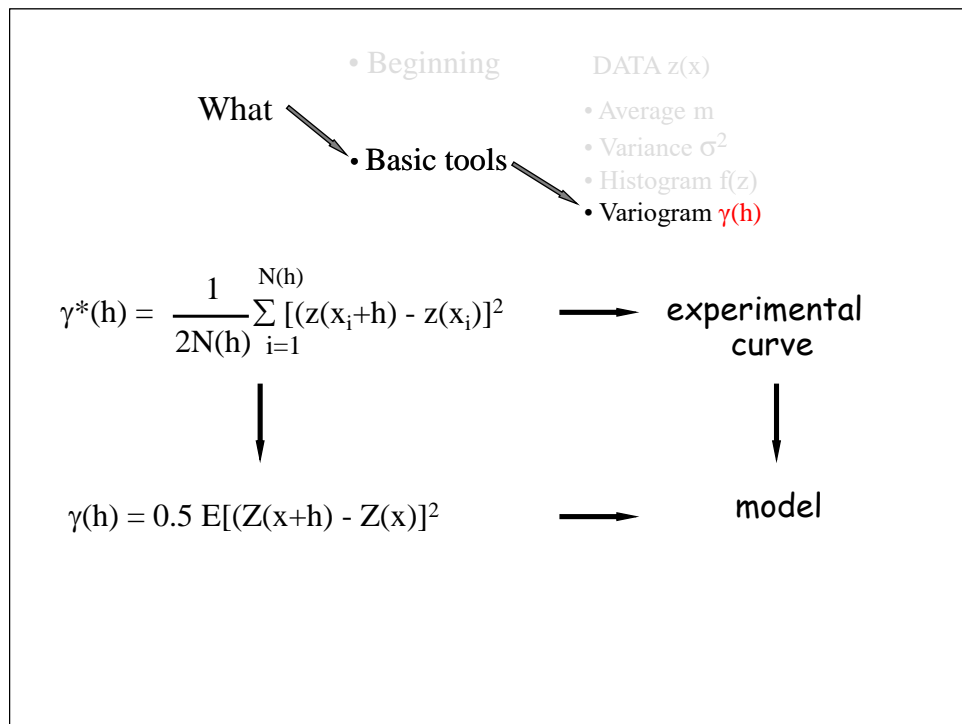
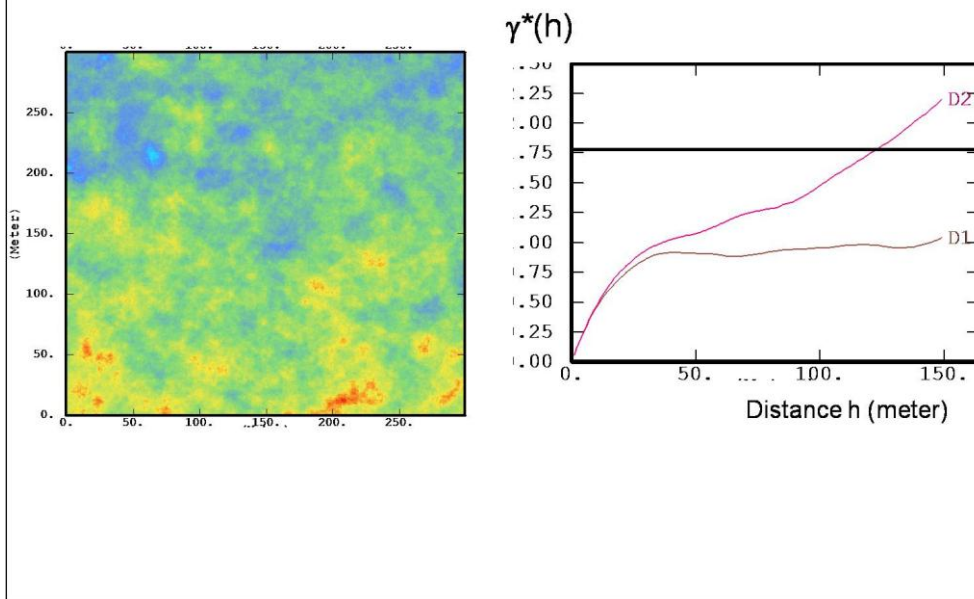

## WHY A MODEL $\gamma(h)$ ?

- knowing  $\gamma(h)$  for all  $h$
- $\gamma(h)$  must have math. properties



- Dispersion variances
- Estimation variances
- Kriging (estimating)
- Simulating

We fit  $\gamma^*(h)$  by a model  $\gamma(h)$

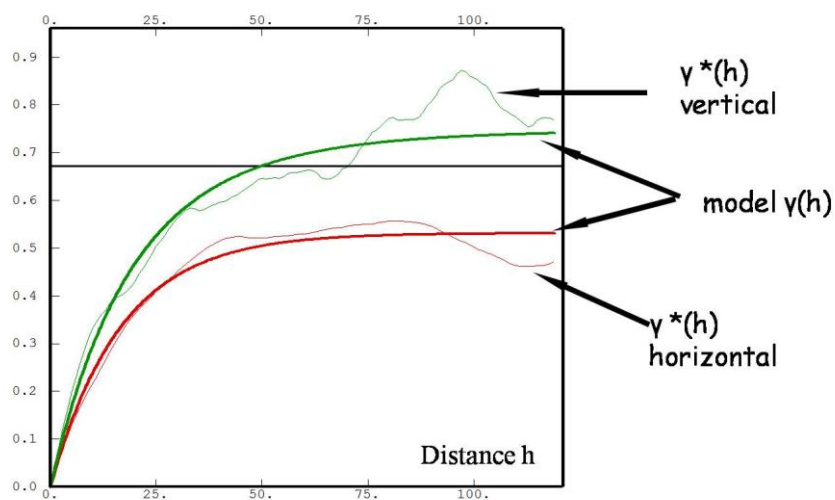

## 1. Nugget effect

$$\begin{cases} \gamma(0) = 0 \\ \gamma(h) = C \quad \text{if } h \neq 0 \end{cases}$$

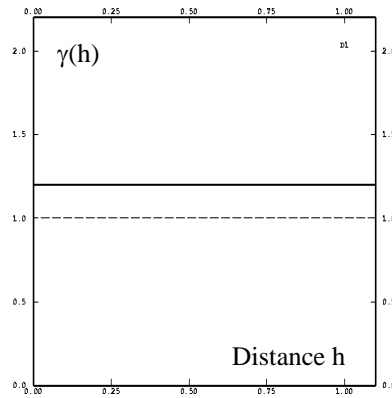

## 2. Spherical

$$\begin{cases} \gamma(h) = C \left[ \frac{3|h|}{2a} - \frac{1}{2} \left( \frac{|h|}{a} \right)^3 \right] & \text{if } h \leq a \\ \gamma(h) = C & \text{if } h \geq a \end{cases}$$

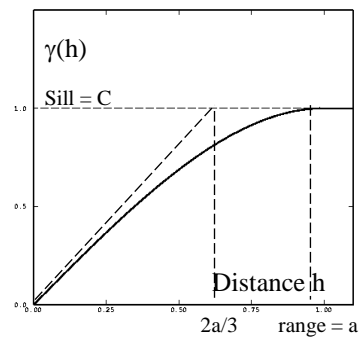

### 3. Exponential

$$\gamma(h) = C \left[ 1 - e^{-\frac{|h|}{a}} \right]$$

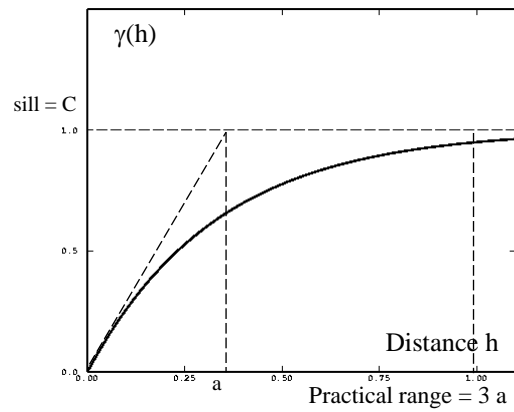

### 4. Gaussian

$$\gamma(h) = C \left[ 1 - e^{-\left(\frac{|h|}{a}\right)^2} \right]$$

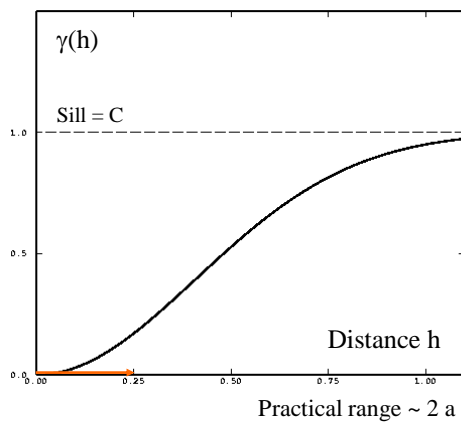

## 5. Linear

$$\gamma(h) = C \frac{|h|}{a}$$

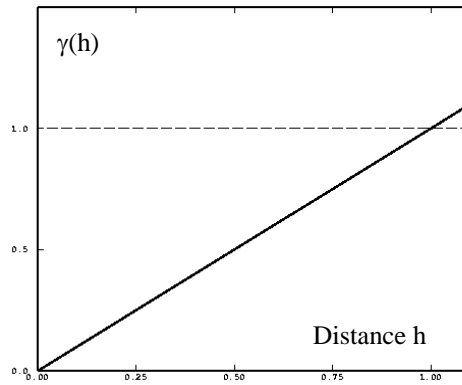

## 6. Power model

$$\gamma(h) = C \left( \frac{|h|}{a} \right)^\alpha$$

$$0 < \alpha < 2$$

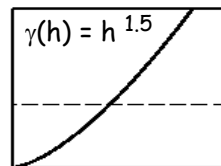
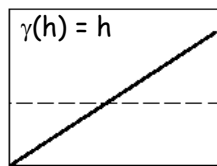
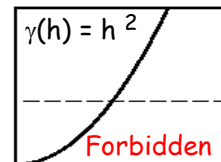
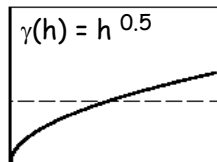

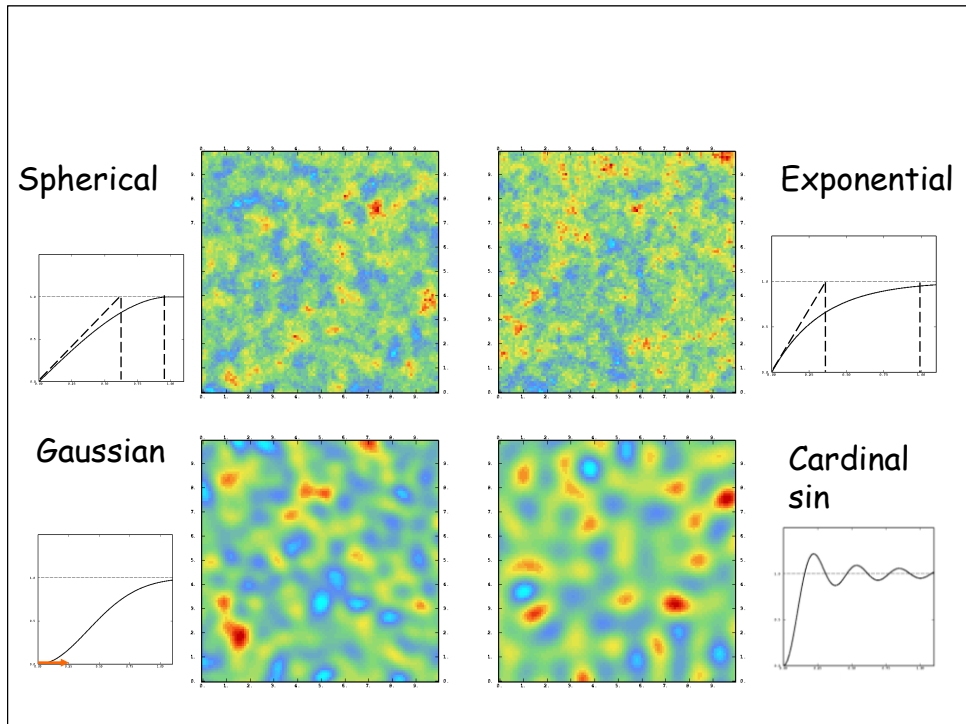

### Properties 1 : range, sill

Example : spherical

$$\begin{cases} \gamma(h) = C \left[ \frac{3|h|}{2a} - \frac{1}{2} \left( \frac{|h|}{a} \right)^3 \right] & \text{si } h \leq a \\ \gamma(h) = C & \text{si } h \geq a \end{cases}$$

Sill = C

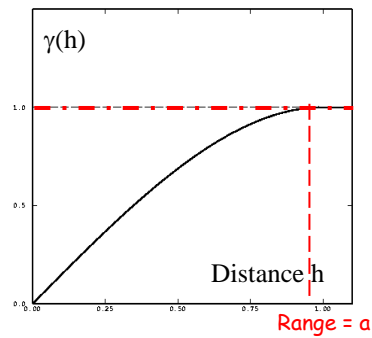

## Practical range

Example : exponential

$$\gamma(h) = C \left[ 1 - e^{-\frac{|h|}{a}} \right]$$

Sill = C

0,95  
C

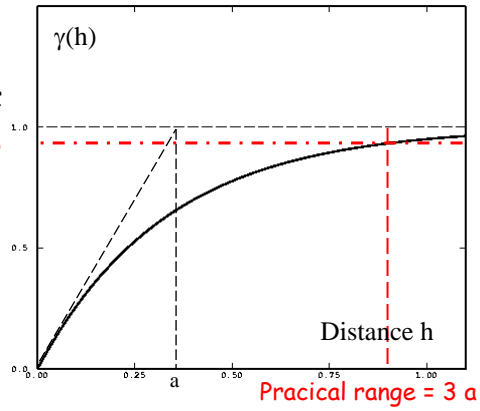

## No range

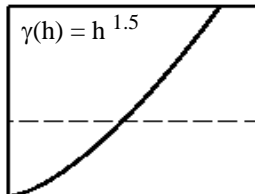
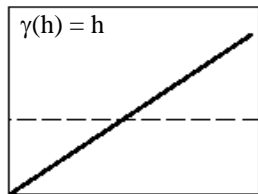
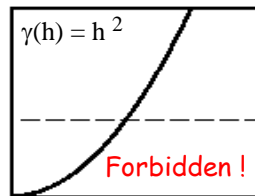
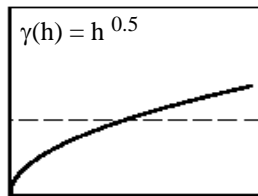

## Behavior at the origin

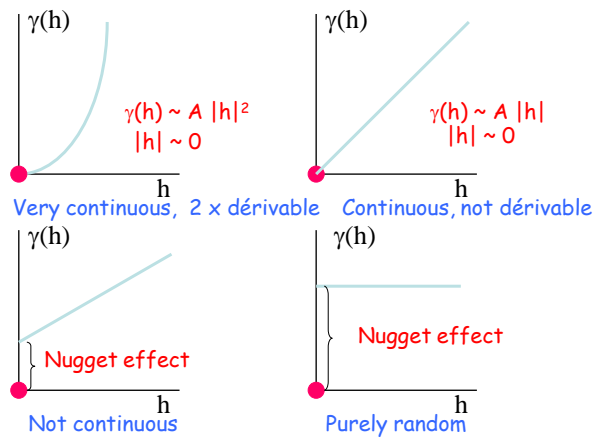

## Nested structures

$\gamma_1(h)$  et  $\gamma_2(h)$  2 authorized models



$\gamma(h) = a \gamma_1(h) + b \gamma_2(h)$  authorized model if  $a \geq 0$ ,  
 $b \geq 0$



Fit many  $\gamma^*(h)$  with few  $\gamma(h)$   
 models

## Nested structures

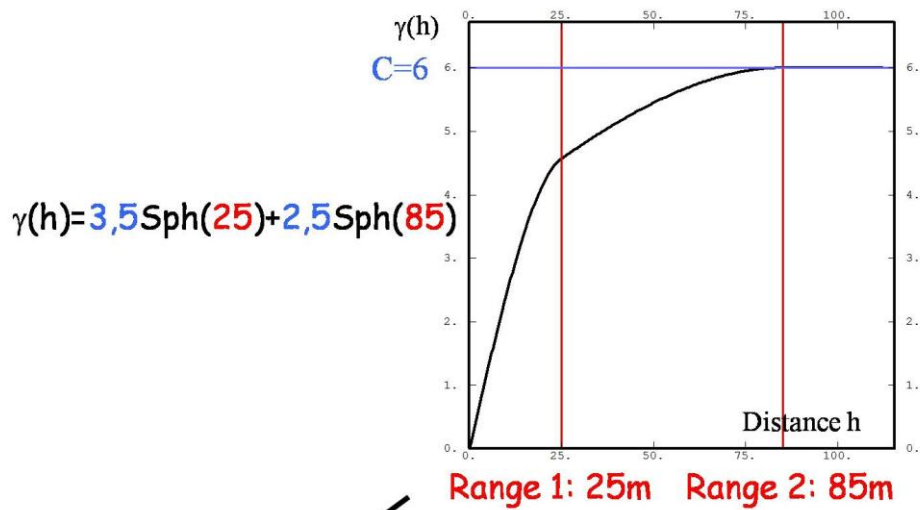

Physical interpretation ?

## Anisotropies

$\gamma(h)$  depends of  $\vec{h}$

$\gamma(\vec{h})$

$\gamma(-\vec{h}) = \gamma(\vec{h})$

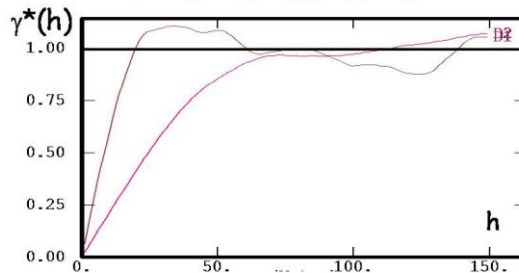
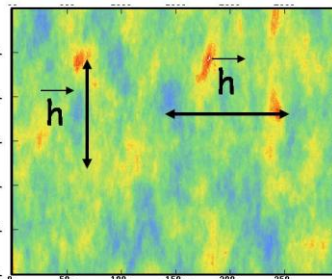

Depends on direction , not orientation

## Geometrical anisotropy

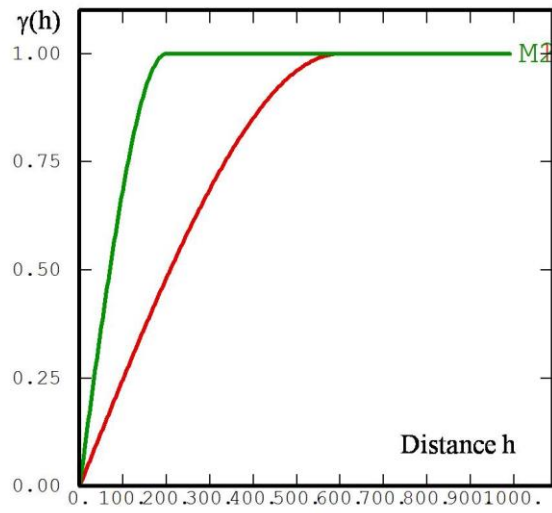

## Geometrical anisotropies

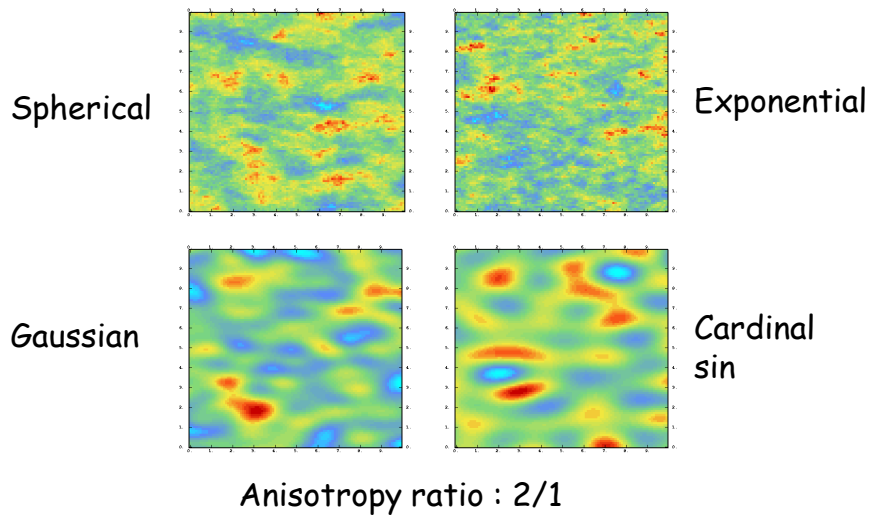

## Zonal anisotropy

Case of nested structures : a structure disappears in 1 direction

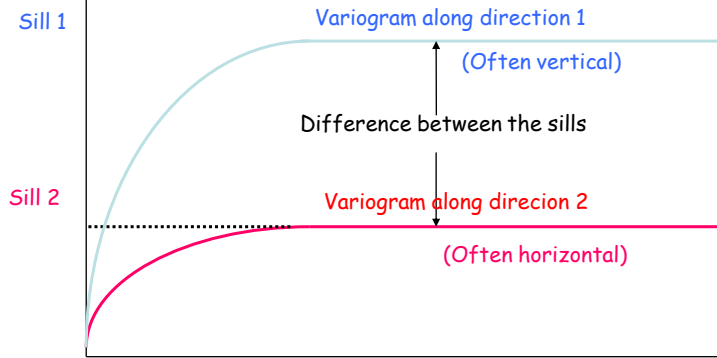

## Zonal anisotropy

« Purely » zonal structures

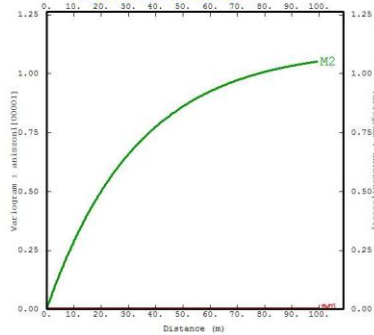

Nested

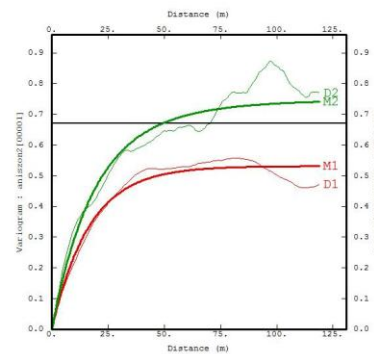

## Zonal anisotropy

« Purely » zonal

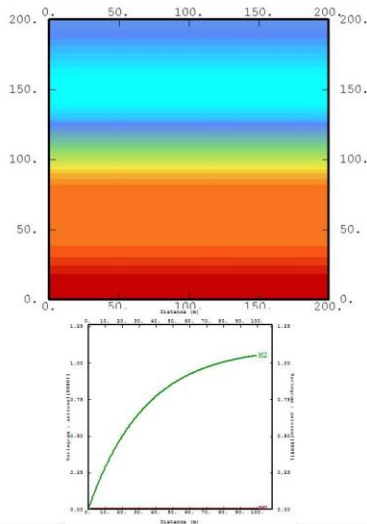

Nested structures

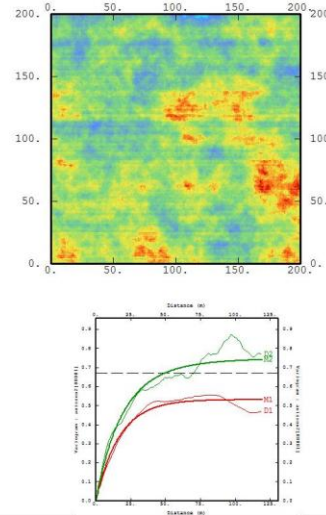

## Anisotropies

Nested structures + anisotropies :

Each structure may have its own anisotropy

Complex resulting model

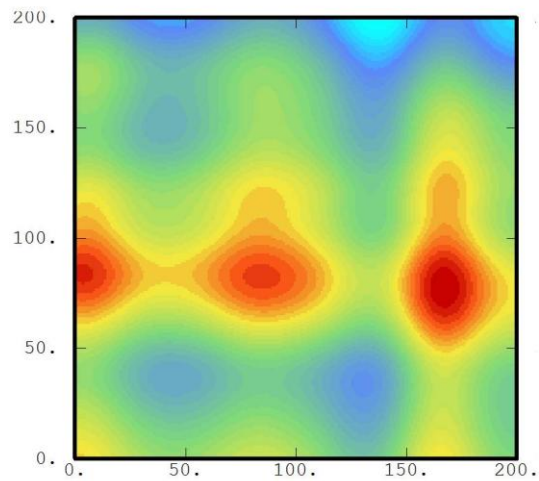

# Anisotropies

Each structure may have its own anisotropy

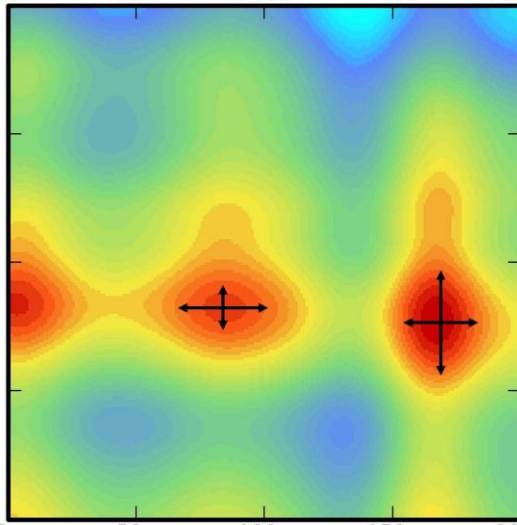

  $\rightarrow \gamma_1(h)$

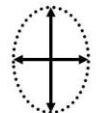
  $\rightarrow \gamma_2(h)$

$\gamma(h) = \gamma_1(h) + \gamma_2(h)$

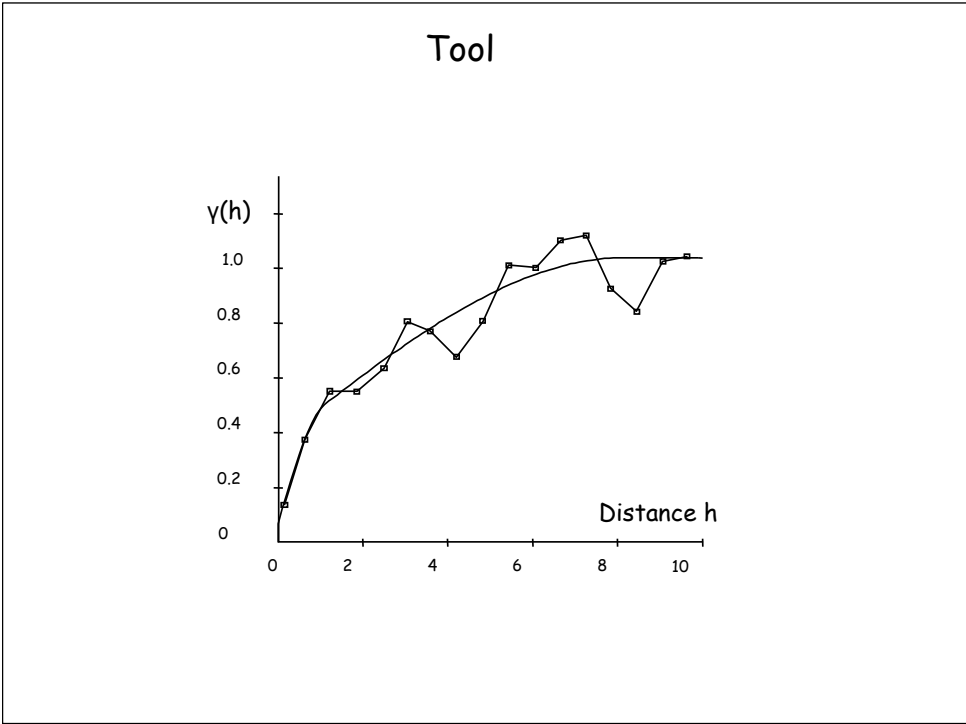
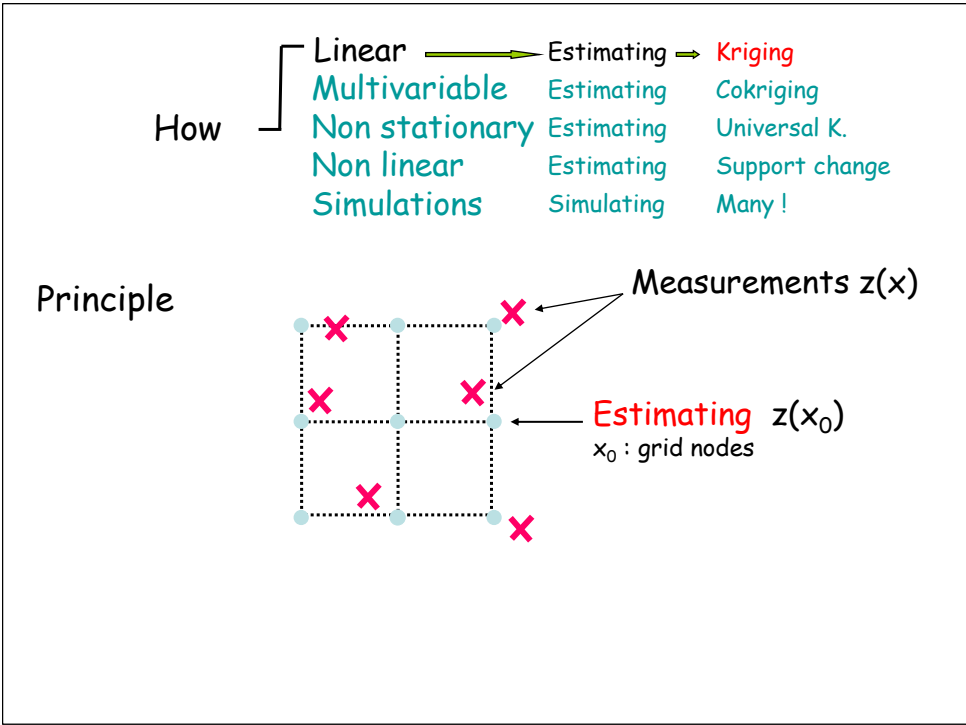

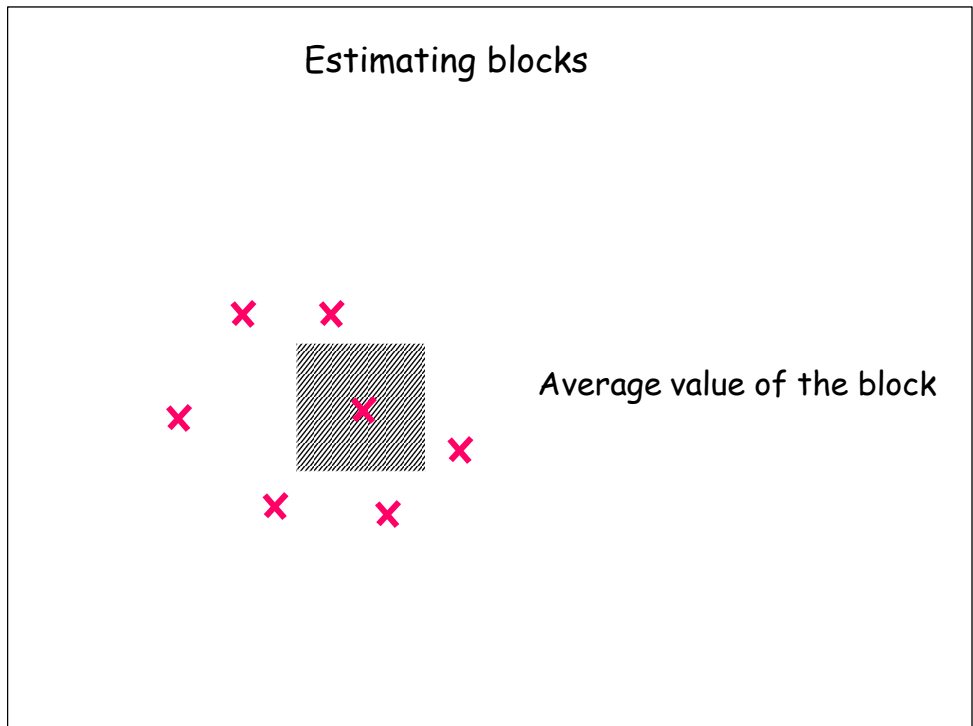
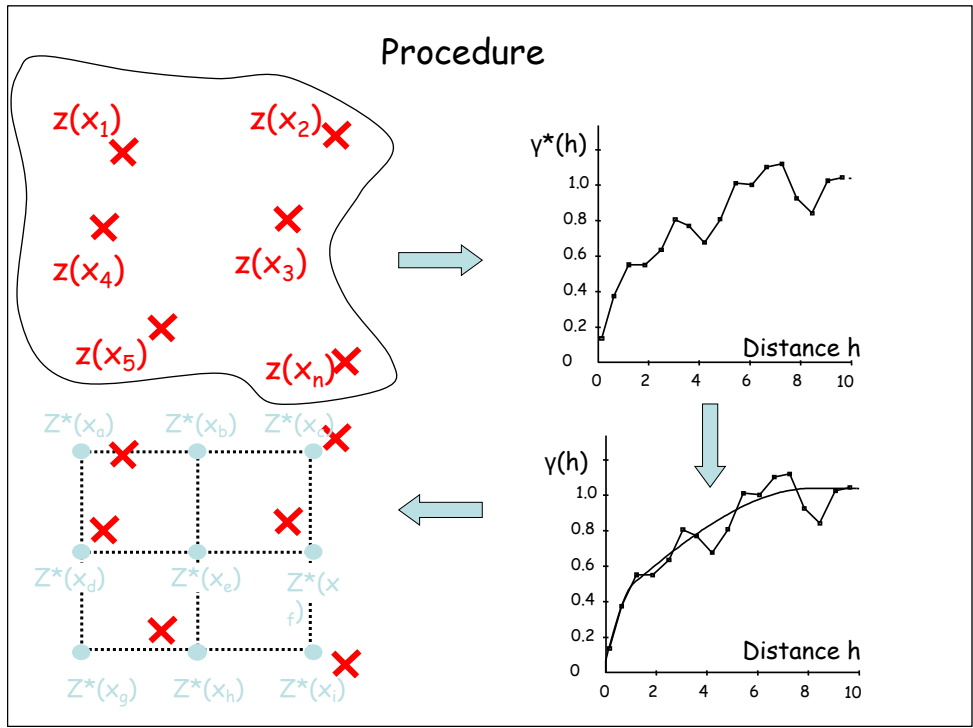

## Estimating all deposit

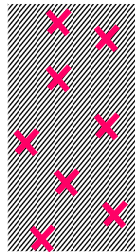

Average value of the deposit

## KRIGING

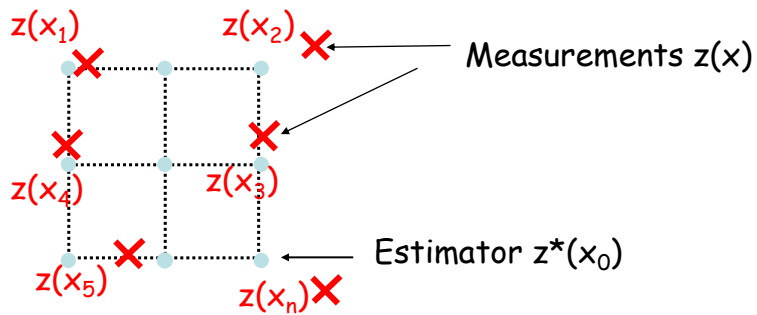

**B** Best  
**L** Linear  
**U** Universal  
**E** Estimator

## KRIGING

**B**

Best

$$\text{VAR}[Z^*(x_0) - Z(x_0)] = \text{minimum}$$

**L**

Linear

$$Z^*(x_0) = \lambda_1 Z(x_1) + \lambda_2 Z(x_2) + \dots + \lambda_n Z(x_n)$$

**U**

Universal

$$E[Z^*(x_0) - Z(x_0)] = 0$$

**E**

Estimator

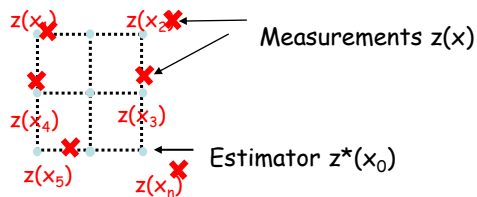

## KRIGING

**U**

Universal

$$E[Z^*(x_0) - Z(x_0)] = 0 = \text{NO BIAS (in average)}$$

**BIAS**

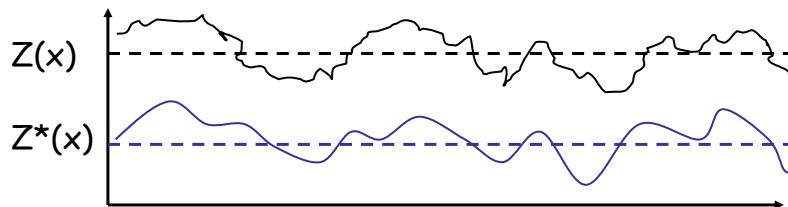

**NO BIAS**

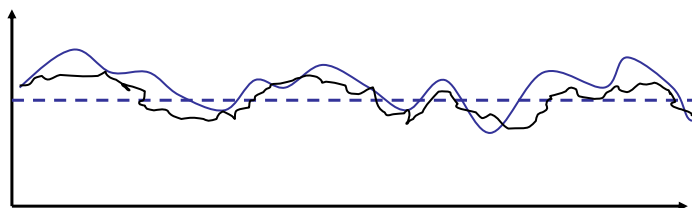

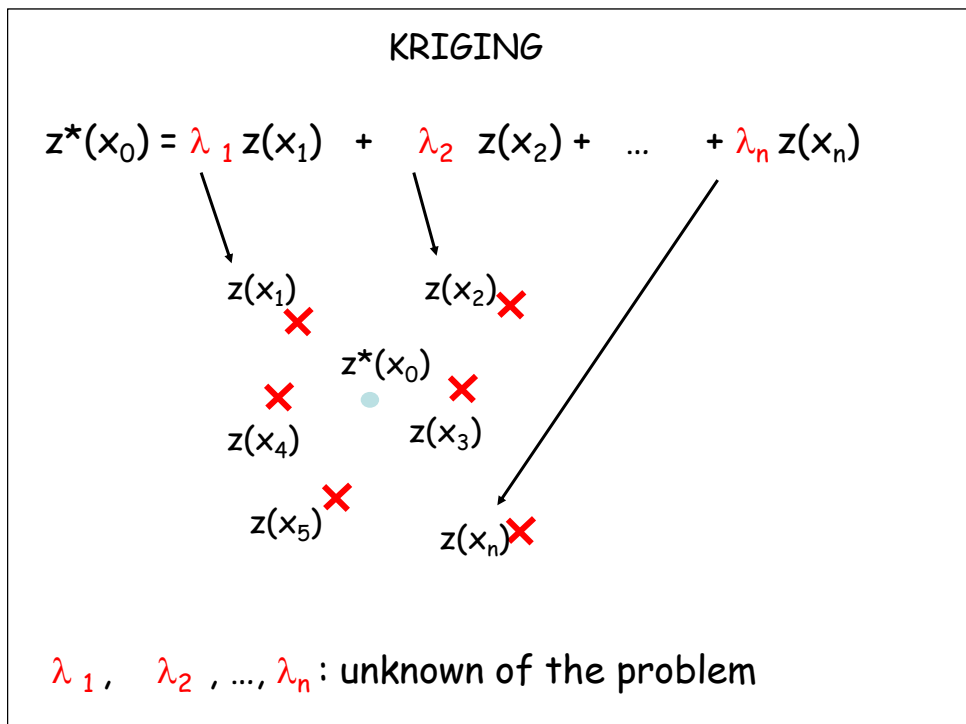
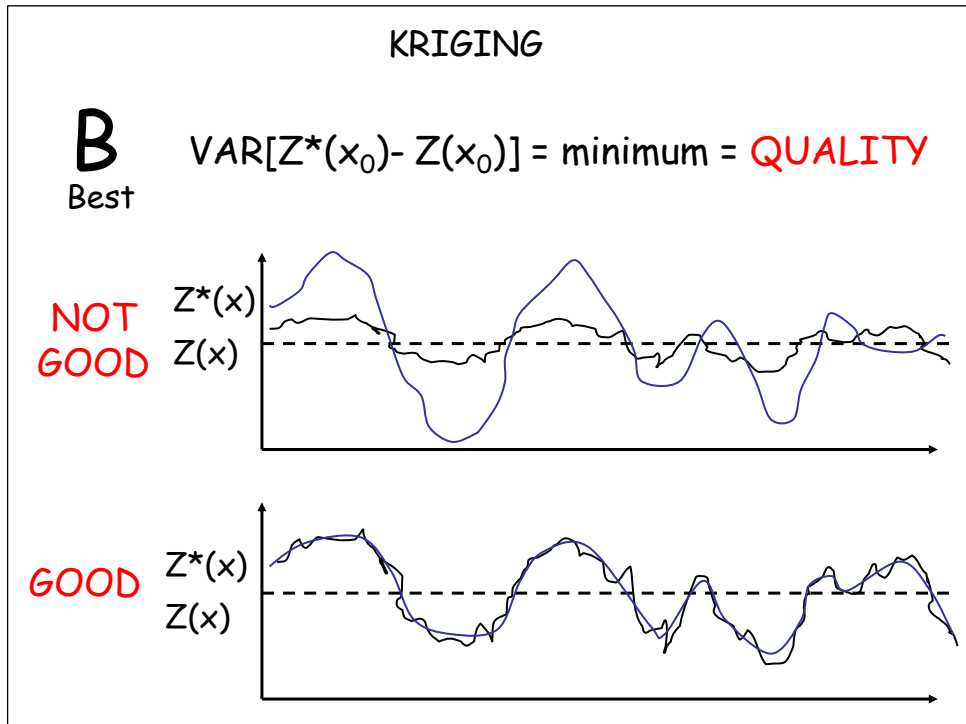

## KRIGING

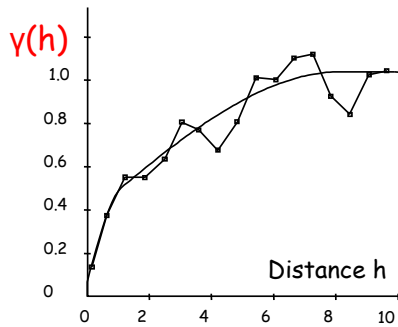

$$\begin{aligned} \text{VAR}[Z^*(x_0) - Z(x_0)] &= \text{Var} \left[ \sum_{i=1}^{i=n} \lambda_i Z(x_i) - Z(x_0) \right] \\ &= - \sum_{i=0}^{i=N} \sum_{j=0}^{j=N} \lambda_i \lambda_j \gamma(x_i - x_j) \end{aligned}$$

## KRIGING

$$\text{VAR}[Z^*(x_0) - Z(x_0)] = \text{minimum}$$

$$E[Z^*(x_0) - Z(x_0)] = 0$$

↓

Solve 
$$\begin{cases} \sum_j \lambda_j \gamma(x_i - x_j) + \mu = \gamma(x_i, x_0) \\ \sum_i \lambda_i = 1 \end{cases}$$

## KRIGING

$$\text{VAR}[Z^*(x_0) - Z(x_0)] = \text{minimum}$$

$$E[Z^*(x_0) - Z(x_0)] = 0$$



Solve

$$\begin{pmatrix} \gamma(x_1 - x_1) & \dots & \gamma(x_1 - x_j) & \dots & \gamma(x_1 - x_n) & 1 \\ \vdots & & \vdots & & \vdots & \\ \gamma(x_i - x_1) & \dots & \gamma(x_i - x_j) & \dots & \gamma(x_i - x_n) & 1 \\ \vdots & & \vdots & & \vdots & \\ \gamma(x_n - x_1) & \dots & \gamma(x_n - x_j) & \dots & \gamma(x_n - x_n) & 1 \\ 1 & & 1 & & 1 & 0 \end{pmatrix} \begin{pmatrix} \lambda_1 \\ \vdots \\ \lambda_i \\ \vdots \\ \lambda_n \\ \mu \end{pmatrix} = \begin{pmatrix} \gamma(x_1, x_0) \\ \vdots \\ \gamma(x_i, x_0) \\ \vdots \\ \gamma(x_n, x_0) \\ 1 \end{pmatrix}$$

### Summary

#### Step 0 : DATA

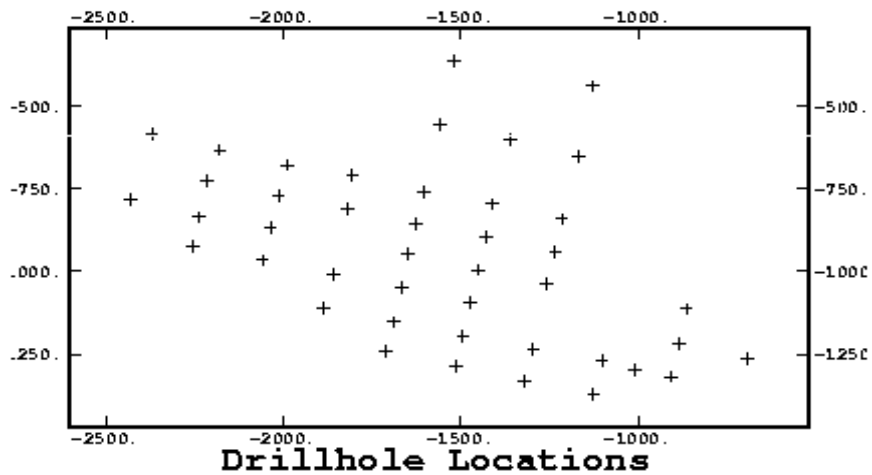

## Summary

### Step 1

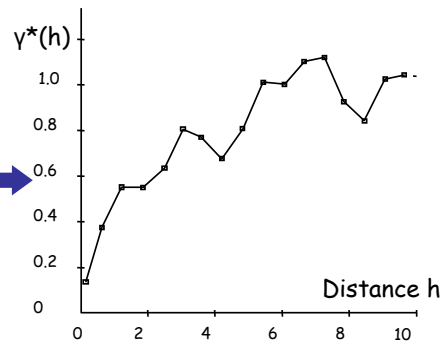
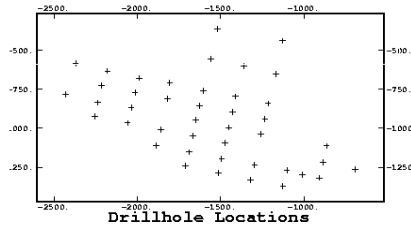

## Summary

### Step 2

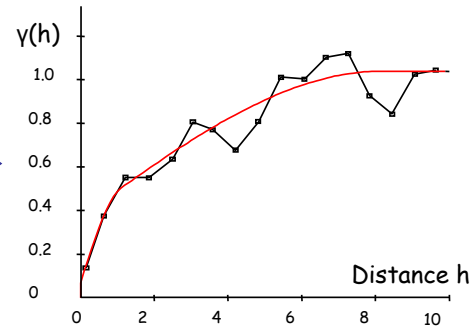
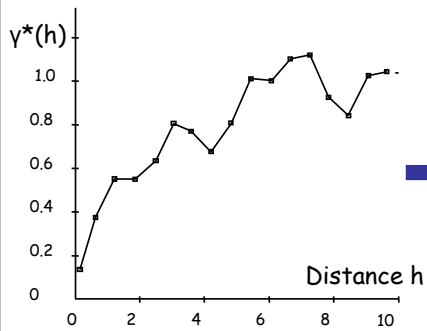

## Summary

### Step 3 : grid

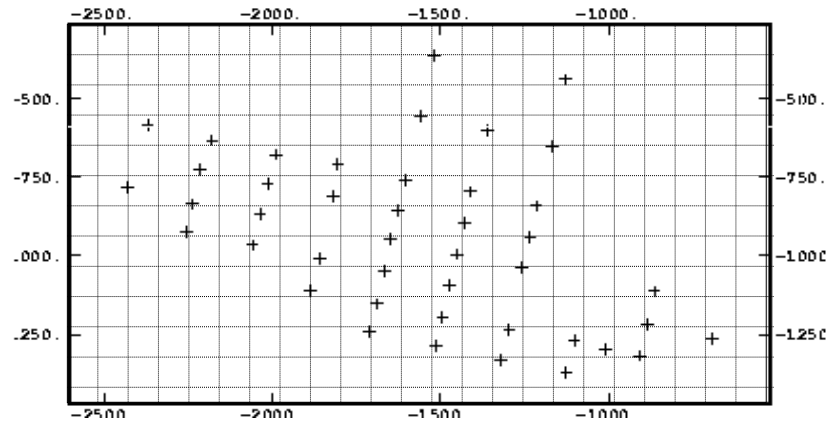

## Summary

### Step 4 : neighborhood

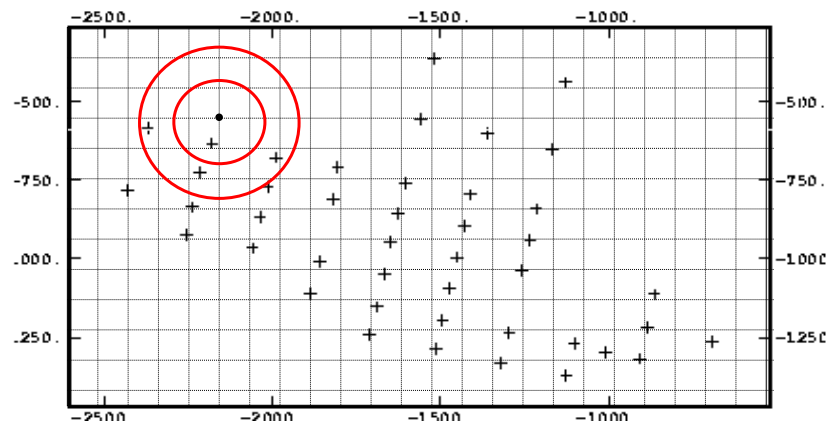

## Summary

### Step 5 : DO loop

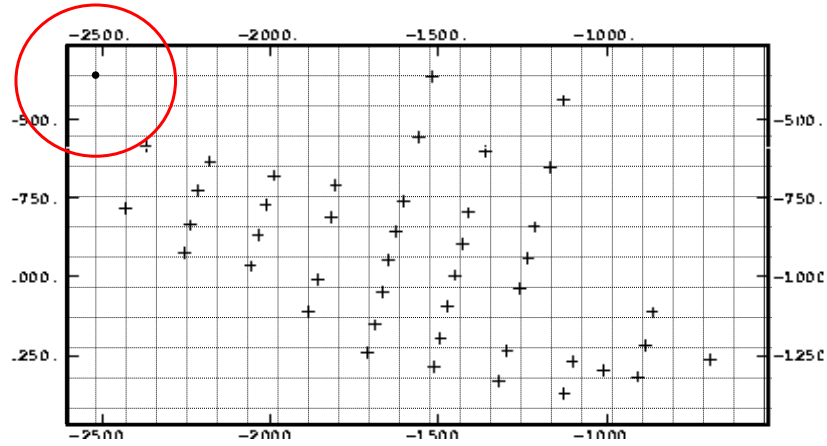

## Summary

### Step 5 : for each node

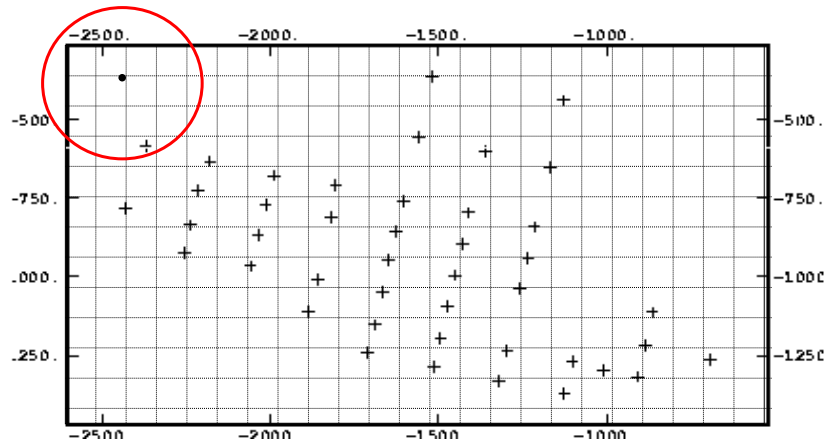

## Summary

### Step 5 :select data

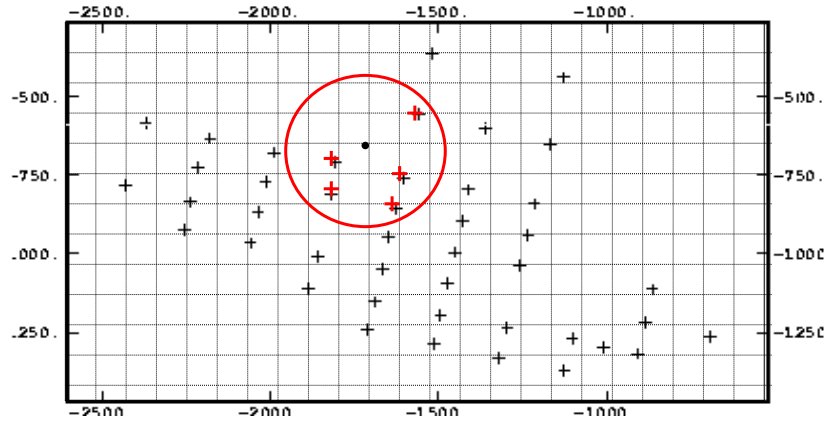

## Summary

### Step 5 :build system

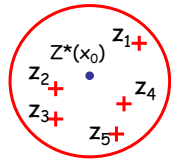

$$\begin{pmatrix} \gamma(x_1 - x_1) & \cdots & \gamma(x_1 - x_3) & \gamma(x_1 - x_5) & 1 \\ \vdots & & \vdots & \vdots & \\ \gamma(x_3 - x_1) & \cdots & \gamma(x_3 - x_3) & \cdots & \gamma(x_3 - x_5) & 1 \\ \vdots & & \vdots & & \vdots & \\ \gamma(x_5 - x_1) & \cdots & \gamma(x_5 - x_3) & \cdots & \gamma(x_5 - x_5) & 1 \\ 1 & & 1 & & 1 & 0 \end{pmatrix} \begin{pmatrix} \lambda_1 \\ \vdots \\ \lambda_3 \\ \vdots \\ \lambda_5 \\ \mu \end{pmatrix} = \begin{pmatrix} \gamma(x_1, x_0) \\ \vdots \\ \gamma(x_3, x_0) \\ \vdots \\ \gamma(x_5, x_0) \\ 1 \end{pmatrix}$$

## Summary

### Step 5 :invert system

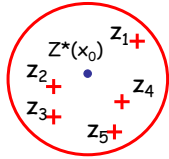

$$\begin{pmatrix} \lambda_1 \\ \vdots \\ \lambda_3 \\ \vdots \\ \lambda_5 \\ \mu \end{pmatrix} = \begin{pmatrix} \gamma(x_1 - x_1) & \cdots & \gamma(x_1 - x_3) & \gamma(x_1 - x_5) & 1 \\ \vdots & & \vdots & \vdots & \\ \gamma(x_3 - x_1) & \cdots & \gamma(x_3 - x_3) & \cdots & \gamma(x_3 - x_5) & 1 \\ \vdots & & \vdots & \vdots & \vdots & \\ \gamma(x_5 - x_1) & \cdots & \gamma(x_5 - x_3) & \cdots & \gamma(x_5 - x_5) & 1 \\ 1 & & 1 & & 1 & 0 \end{pmatrix}^{-1} \begin{pmatrix} \gamma(x_1, x_0) \\ \vdots \\ \gamma(x_3, x_0) \\ \vdots \\ \gamma(x_5, x_0) \\ 1 \end{pmatrix}$$

## Summary

### Step 5 :built estimator

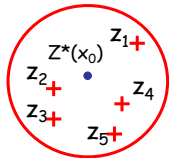

$$z^*(x_0) = \lambda_1 z(x_1) + \lambda_2 z(x_2) + \lambda_3 z(x_3) + \lambda_4 z(x_4) + \lambda_5 z(x_5)$$

## Summary

Step 5 :repeat

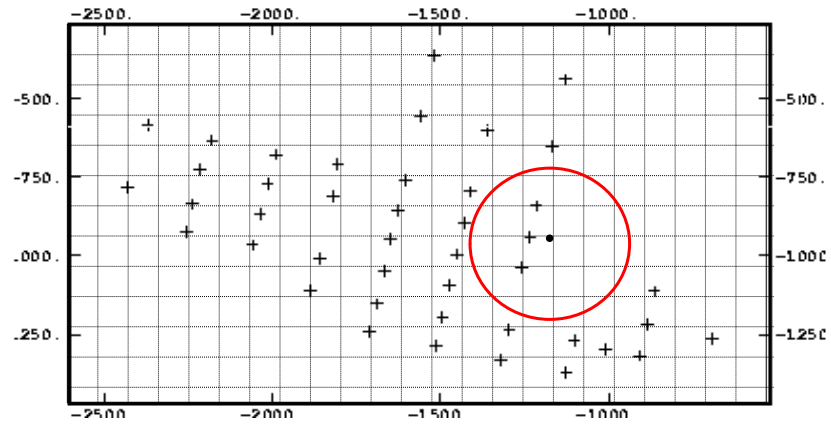

## Summary

Block model

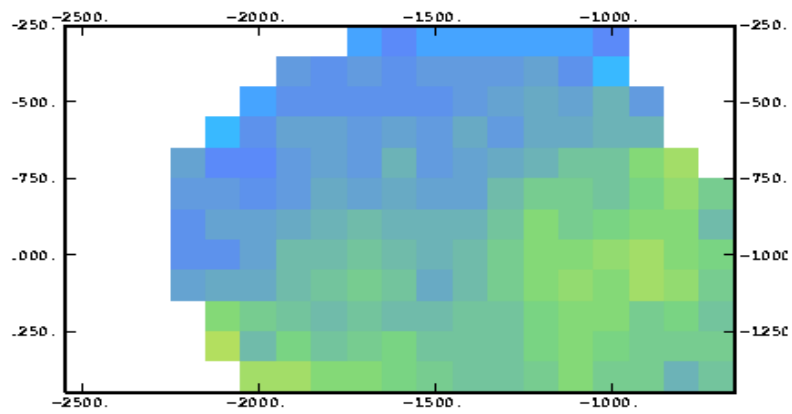

# Summary

## Accuracy

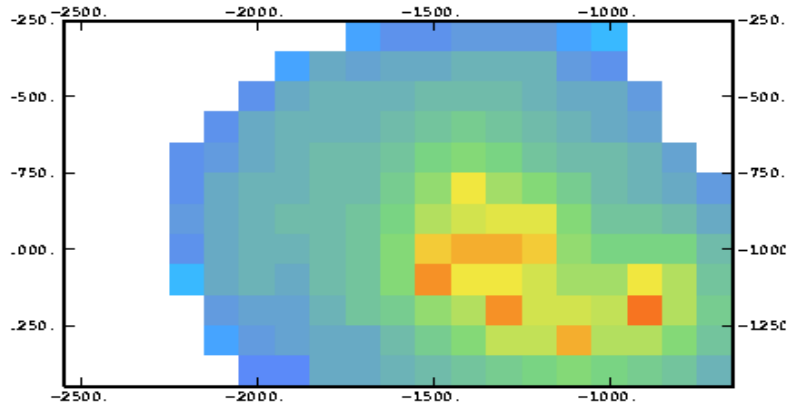

Goto  
138

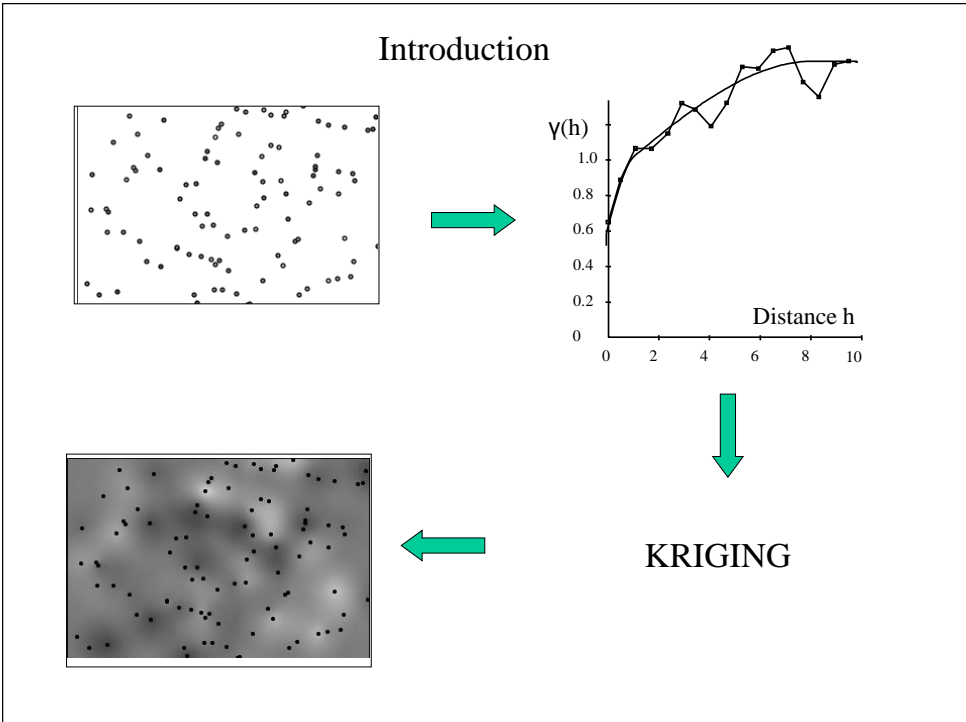
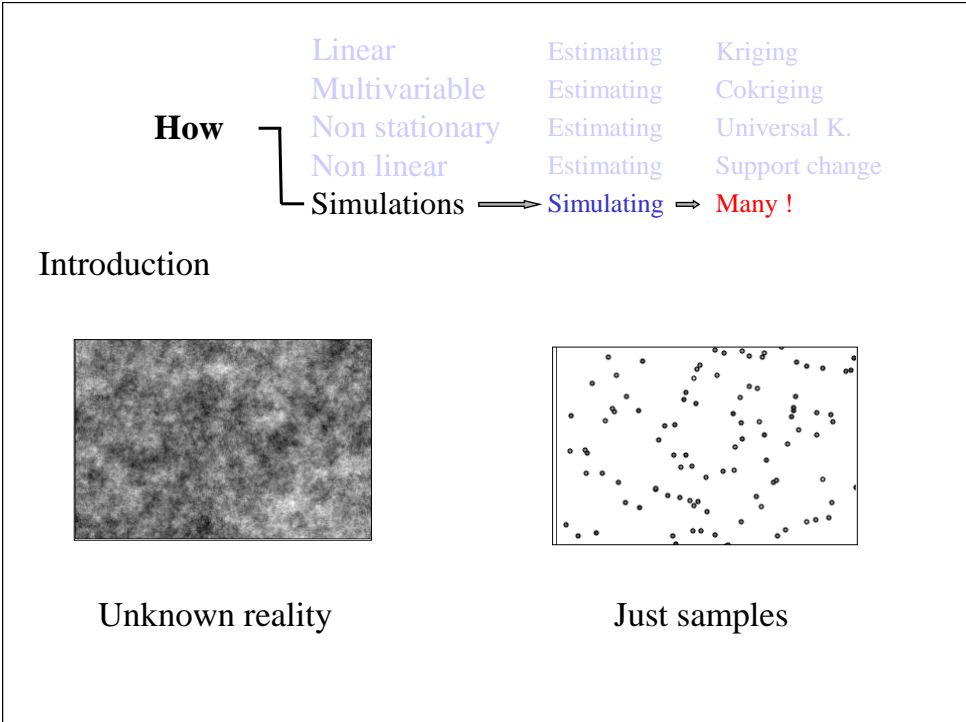

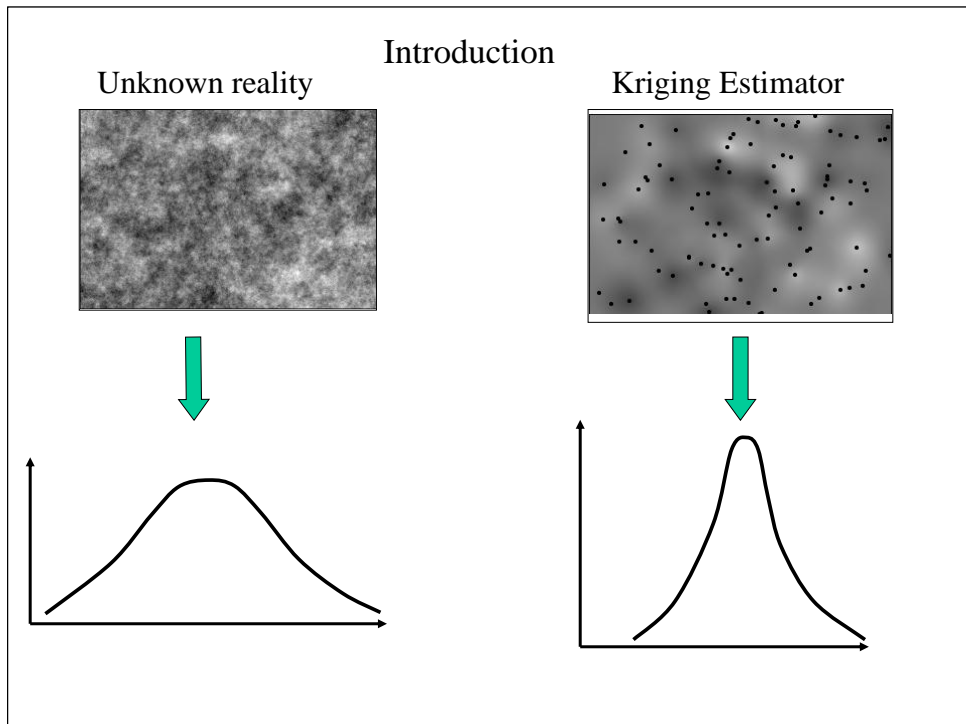
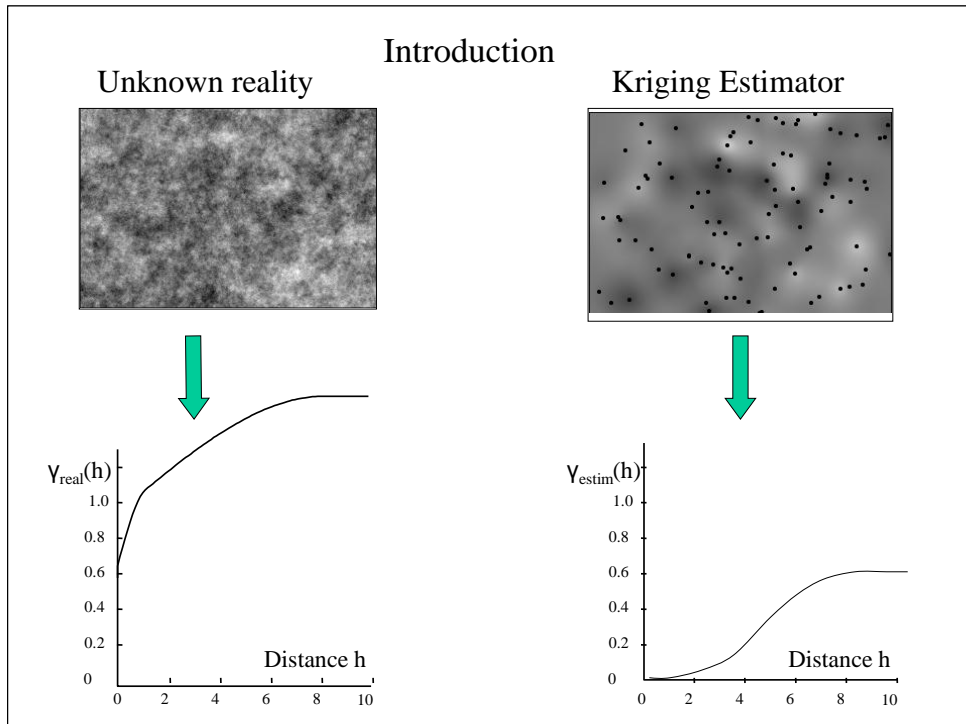

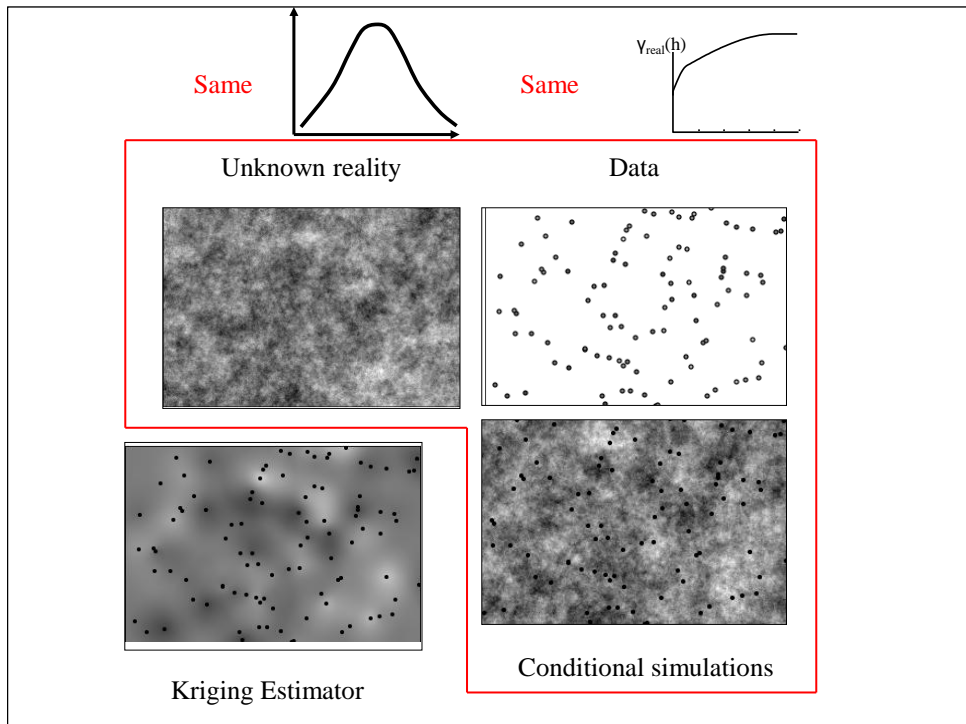
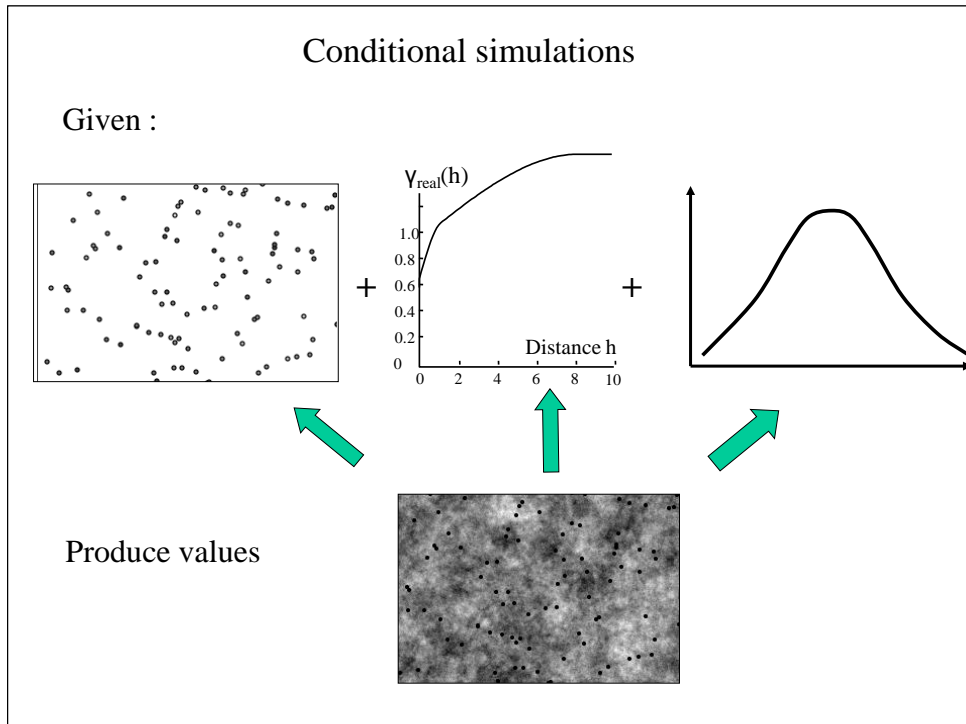

## Why simulations ?

- Gives realistic views of reality
- Optimizing sampling mesh
- Exploitation simulation
- Incertitudes in planification
- ...

## C - Geotechnics specificity



Additivity

Directionality

Scale change

### Additivity

*« Quantities are additive if the averaged quantity equals the average of the quantities »*

**Why are the grades additive ?**

**Ore density constant**

$$\left. \begin{array}{l}
 \boxed{V_1} \text{ grade } Z(V_1) \rightarrow \frac{Q_1}{T} \\
 \boxed{V_2} \text{ grade } Z(V_2) \rightarrow \frac{Q_2}{T}
 \end{array} \right\} \begin{array}{l}
 \text{average} \\
 \text{of grades}
 \end{array} = \frac{Q_1 + Q_2}{2T} = Z(V_1 \cup V_2) \quad \boxed{2V}$$

## Additivity

« *Quantities are additive if the averaged quantity equals the average of the quantities* »

### Ore density not constant

$$\begin{array}{l}
 \boxed{V_1} \text{ grade } Z(V_1) \rightarrow \frac{Q_1}{T_1} \\
 \boxed{V_2} \text{ grade } Z(V_2) \rightarrow \frac{Q_2}{T_2}
 \end{array}
 \left. \vphantom{\begin{array}{l} V_1 \\ V_2 \end{array}} \right\} \begin{array}{l} \text{average} \\ \text{of grades} \end{array} = \frac{Q_1}{2T_1} + \frac{Q_2}{2T_2}$$

$\neq$

$$= \frac{Q_1 + Q_2}{T_1 + T_2} = Z(V_1 \cup V_2)$$

2V

## Additivity

Non-Additivity : ratio of two quantities which both change when moving along the space

- Metallurgical recovery
- FF with variable support

No additive No kriging but some alternatives (Cristian presentation on FF)

## Directionality

RQD is additive by direction but depends on the sample direction

IRS, PLT are directional

Other example: permeability

FF can be directional when Terzaghi correction is not possible

Directionality → Additive by direction  
Not additive when mixing directions

## Directionality

Immediate solution: as many estimations as directions (RQD, Convenio 2014)

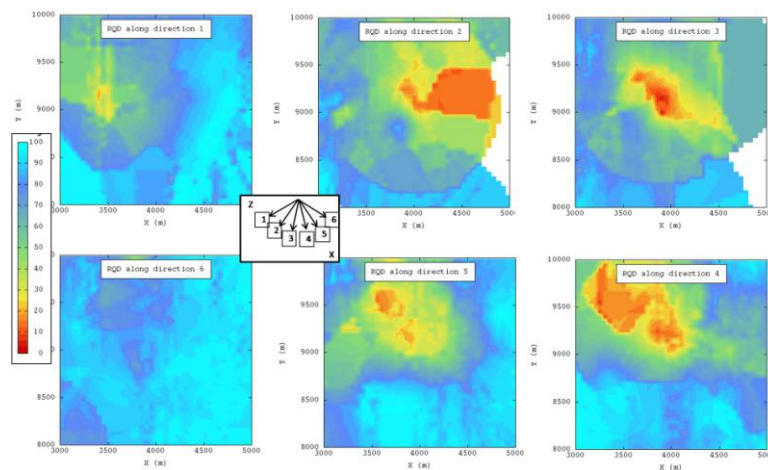

Research in the future: Geostatistics in 5D:  
Space  $\times [0, 180^\circ] \times [-90^\circ, 90^\circ]$

## Scale change

Property change with support

↔ Averaging property of samples inside block does not give correct idea of block property

↔ Change of scale "not linear"

Example:

Immediate solution: block kriging property using samples property gives average behavior of samples inside block

## Scale change

### Point Load Testing (PLT)

Increase support, increase probability encountered micro defect

### Intact Rock Strength (IRS)

Interpretation of a block IRS?

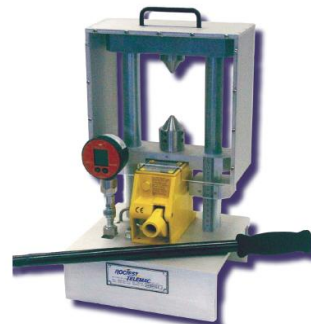

## The 3 key questions of the Geotechnicians

- 1 - Is the variable additive ?
- 2 - Must I account for the sample direction ?
- 3 - Sample property  $\rightarrow$  Block property ?

FF

- 1 - Is the variable additive ?

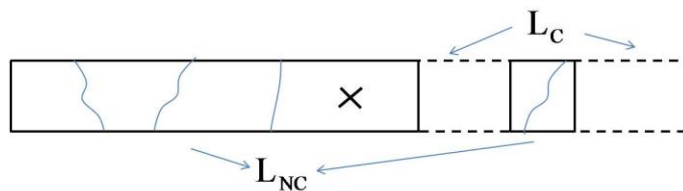

$L_{NC}$  : total length of Non Cruhed part of the sample

$L_C$  : total length of Cruhed part of the sample

$$L_{NC} + L_C = 1.5m$$

$N_{fract}$  : number of fractures (corrected or not) along  $L_{NC}$

FF

1 - Is the variable additive ?

$N_{\text{fract}}$  : Additive (if Terzaghi corrected)

$L_{\text{NC}} = 1.5 \cdot L_C$  : Additive (if crushing not directional)

$FF_{\text{True}}(x) = \frac{N_{\text{fract}}(x)}{L_{\text{NC}}(x)}$  : NOT additive

$FF_{\text{Corregido}}(x) = \frac{N_{\text{fract}}(x) + 40 \cdot L_C(x)}{1.5}$  : Additive

FF

2 - Must I account for the sample direction ?

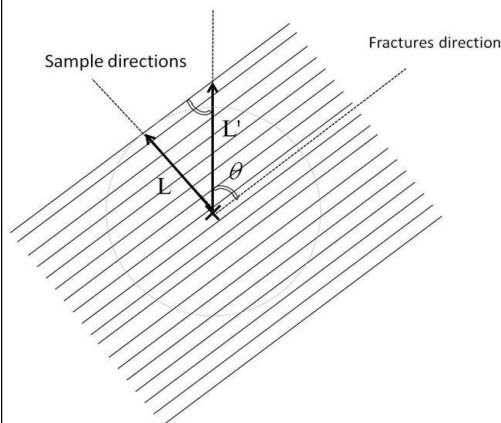

$$L' = \frac{L}{\sin \theta}$$

$$FF = \frac{N_{\text{tot}}(x)}{L} = \frac{N_{\text{tot\_corrected}}(x)}{L'}$$

$$\rightarrow N_{\text{tot\_corrected}}(x) = \frac{N_{\text{tot}}(x)}{\sin(\theta)}$$

(Terzaghi, 1963)

FF

$$N_{fract}(x) = \sum_{\theta=1}^{n_{\theta}} N(\theta, x)$$

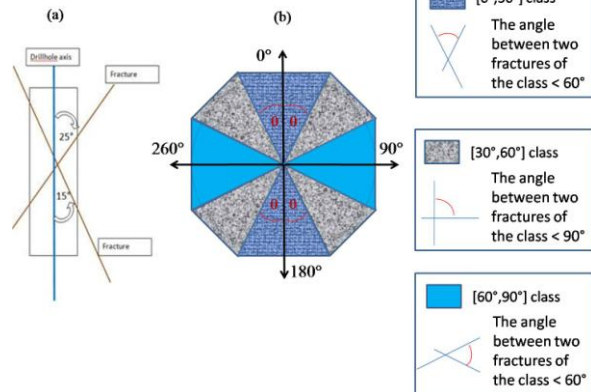

2 - Must I account for the sample direction ?

If Terzaghi corrected → No

But: Terzaghi, crude approximation...

FF

3 - Sample property → Block property ?

Remark: FF=1D ≠ 2D density ≠ 3D density  
(Priest & Hudson 1973, 1981, 1983)

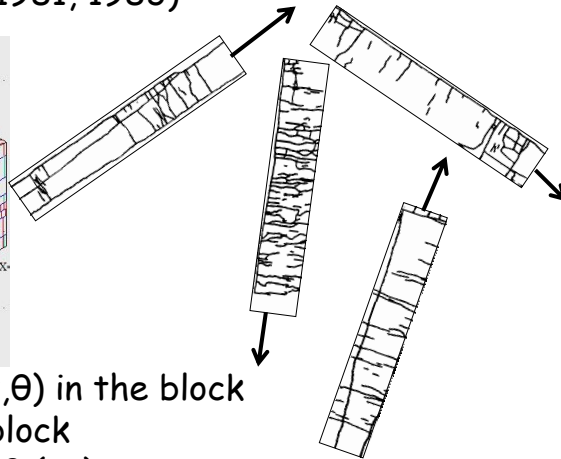
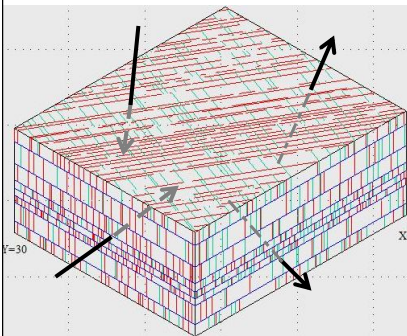

- Take a 1D sample FF(x,θ) in the block
- Move "x" all over the block
- Change the directions θ (+φ)
- FF block kriging ↔ 1D FF average

# RQD

## 1 - Is the variable additive ?

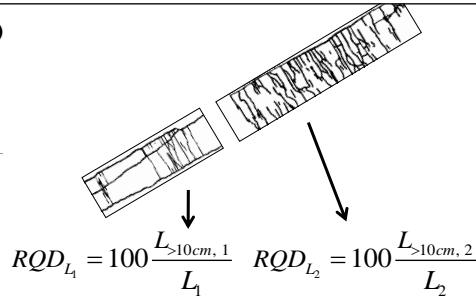
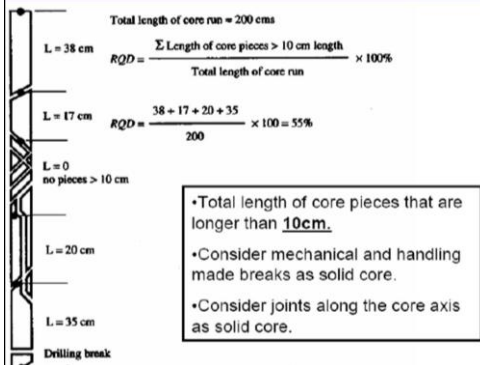

$$RQD_{L_1} = 100 \frac{L_{>10cm, 1}}{L_1} \quad RQD_{L_2} = 100 \frac{L_{>10cm, 2}}{L_2}$$

$$RQD_{L_1 \cup L_2} = 100 \frac{L_{>10cm, 1} + L_{>10cm, 2}}{L_1 + L_2}$$

$$= \frac{L_1 100 \frac{L_{>10cm, 1}}{L_1} + L_2 100 \frac{L_{>10cm, 2}}{L_2}}{L_1 + L_2}$$

$$= \frac{L_1 RQD_{L_1} + L_2 RQD_{L_2}}{L_1 + L_2}$$

For a given direction, RQD is additive

# RQD

## 2 - Must I account for the sample direction ? → YES

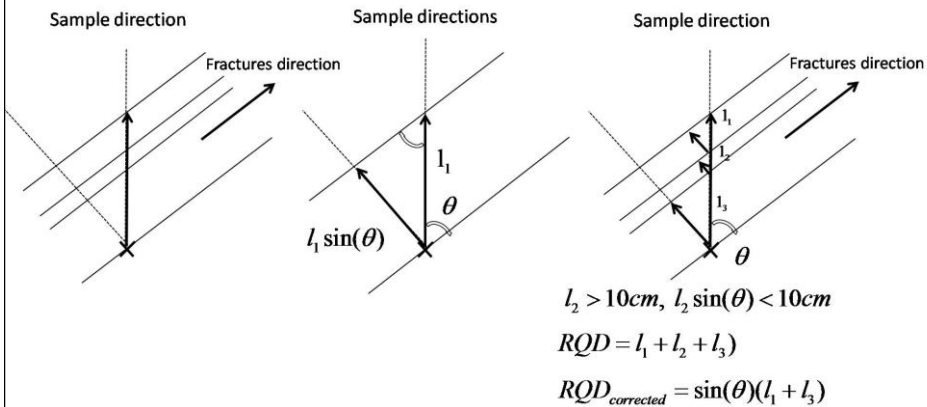

Terzaghi not possible

## Directionality

Immediate solution: as many estimations as directions (RQD, Convenio 2014)

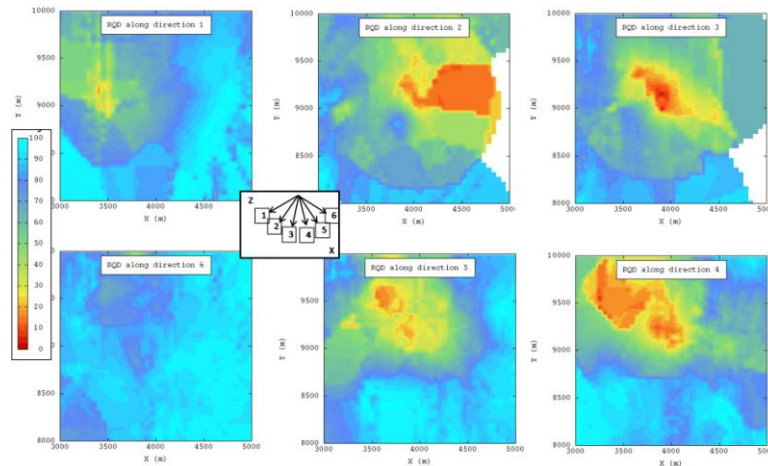

Research in the future: Geostatistics in 5D:  
Space  $\times [0, 180^\circ] \times [-90^\circ, 90^\circ]$

## RQD

3 - Sample property  $\rightarrow$  Block property ?

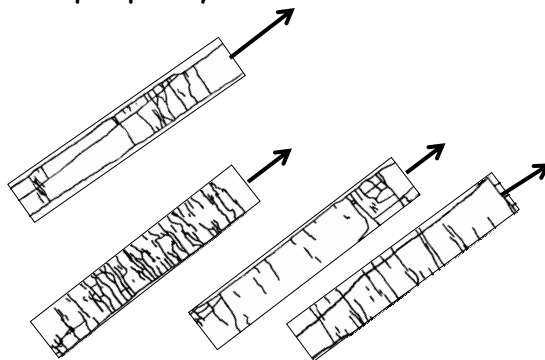
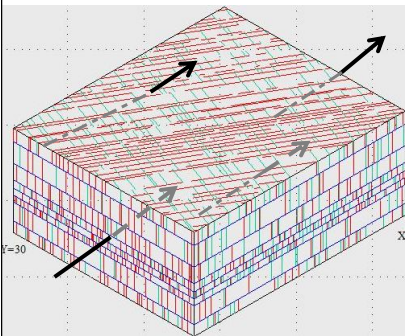

- Take a 1D sample RQD  $(x, \theta)$  in the block
- Move "x" all over the block
- Keep the same direction  $\theta$  ( $+\phi$ )
- RQD  $(\theta)$  block kriging  $\leftrightarrow$  RQD  $(\theta)$  average

## Point Load Testing (PLT)

*Open Discussion*



Increase support, increase probability encountered micro defect

- 1 - Is the variable additive ?
- 2 - Must I account for the sample direction ?
- 3 - Sample property → Block property ?

## Intact Rock Strength (IRS)

*Open Discussion*



R0	Extremely Weak	Indented by Thumbnail	0.25 - 1.0
R1	Very Weak	Crumbles under firm blow of geologic hammer pick, peeled by pocket knife	1.0 - 5.0
R2	Weak	Shallow indentation under firm blow of pick end of geologic hammer	5.0 - 25
R3	Medium Strong	Fractured with single firm blow of geologic hammer	25 - 50
R4	Strong	Requires more than one blow of hammer to fracture	50 - 100
R5	Very Strong	Requires many blows of hammer to fracture	100 - 250
R6	Extremely Strong	Can only be chipped with strong blows of hammer	> 250

\* International Society for Rock Mechanics

- 1 - Is the variable additive ?
- 2 - Must I account for the sample direction ?
- 3 - Sample property → Block property ?

## Rating

Open Discussion

Clasificación geomecánica RMR (Bieniawski, 1989)

Parámetros de clasificación

	Resistencia de la matriz rocosa (MPa)	Esayo de carga puntual	> 10	10-4	4-2	2-1	Compresión simple (MPa)		
1	Compresión simple		> 250	250-100	100-50	50-25	25-5	5-1	< 1
	Puntuación		15	12	7	4	2	1	0
2	RQD		90%-100%	75%-90%	50%-75%	25%-50%	< 25%		
	Puntuación		20	17	13	6	3		
3	Separación entre diaclasas		> 2 m	0,5-2 m	0,2-0,6 m	0,06-0,2 m	< 0,06 m		
	Puntuación		20	15	10	8	5		
4	Longitud de la discontinuidad		< 1 m	1-3 m	3-10 m	10-20 m	> 20 m		
	Puntuación		6	4	2	1	0		
	Abertura		Nada	< 0,1 mm	0,1-1,0 mm	1-5 mm	> 5 mm		
	Puntuación		6	5	3	1	0		
	Rugosidad		Muy rugosa	Rugosa	Ligeramente rugosa	Ondulada	Suave		
	Puntuación		6	5	3	1	0		
	Relleno		Ninguno	Relleno duro < 5 mm	Relleno duro > 5 mm	Relleno blando < 5 mm	Relleno blando > 5 mm		
	Puntuación		6	4	2	2	0		
	Alteración		Inalterada	Ligeramente alterada	Moderadamente alterada	Muy alterada	Descompuesta		
	Puntuación		6	5	3	1	0		
5	Agua freática		Caudal por 10 m de diámetro	Nulo	< 10 litros/min	10-25 litros/min	25-125 litros/min	> 125 litros/min	
	Relación Presión de agua/Tensión principal mayor		0	0-0,1	0,1-0,2	0,2-0,5	> 0,5		
	Estado general		Seco	Ligeramente húmedo	Húmedo	Gotearlo	Agua fluyendo		
Puntuación		15	10	7	4	0			

Replace continuous measure by ratings  
→ spatial discontinuities

## Rating

Open Discussion

Objectives of the rating:

- Normalization of the parameters
- Reducing the impact of the uncertainties

Possible alternative ?

- Statistical normalization
- Uncertainty quantification

→ Convenio 2015

# Geostatistics for Geotechnicians

## FF Tutorial

### 0 General

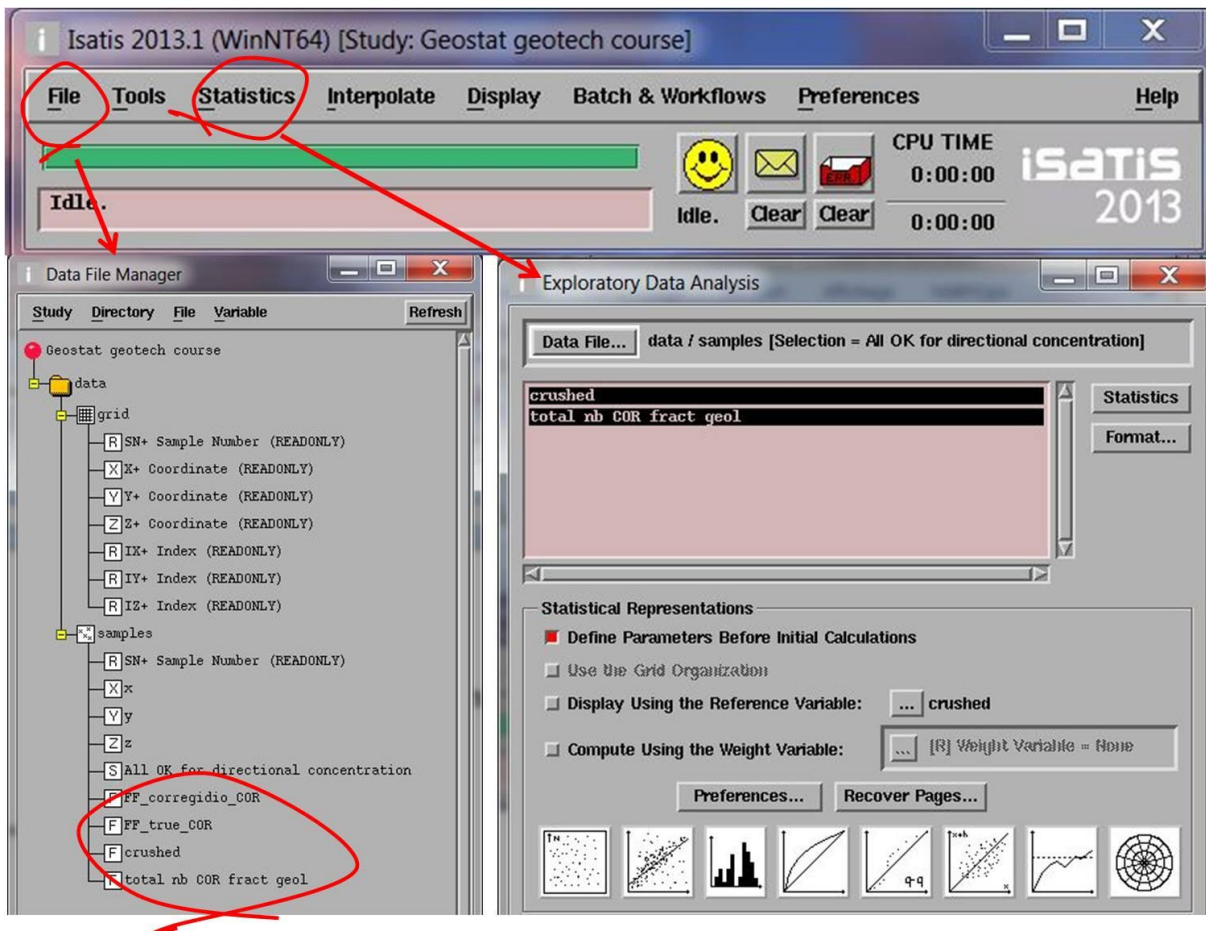

# 1 Data

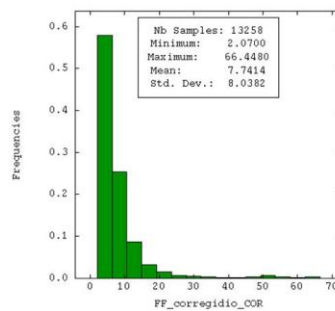
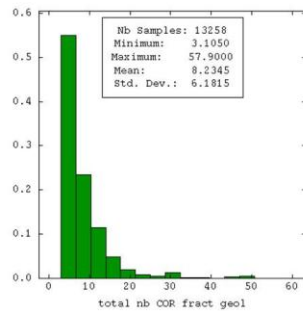
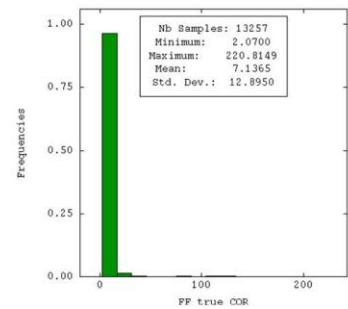
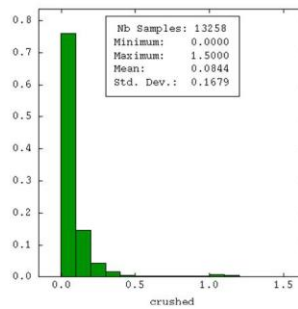
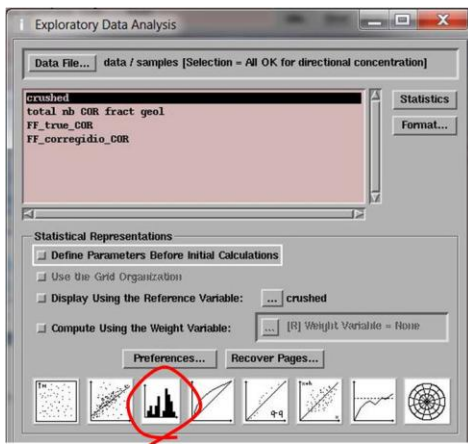
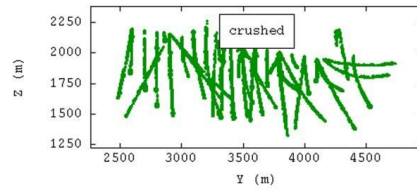
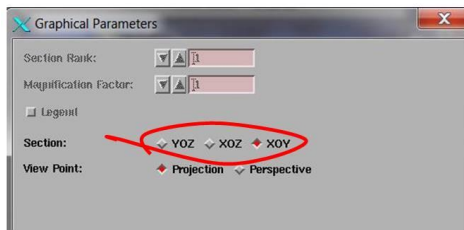
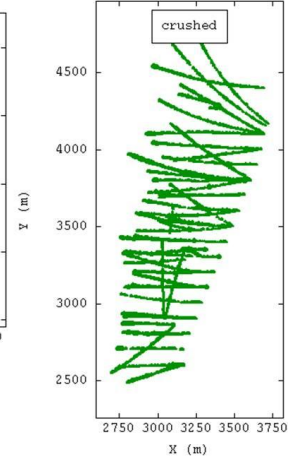
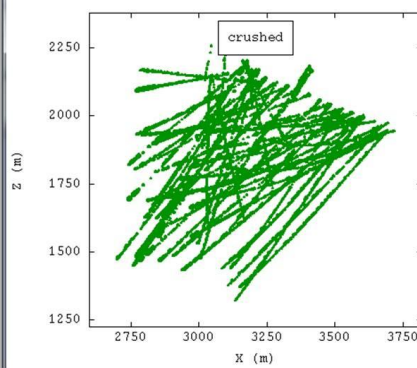
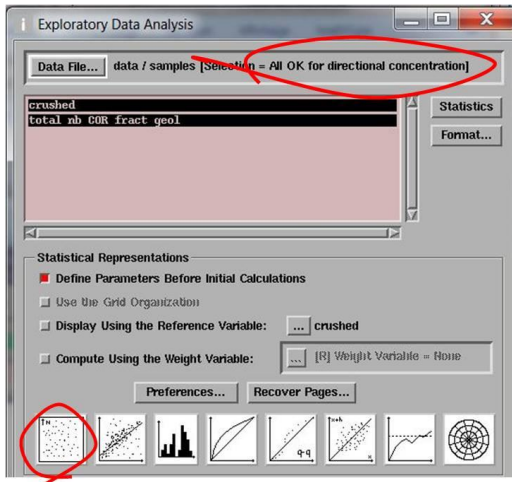

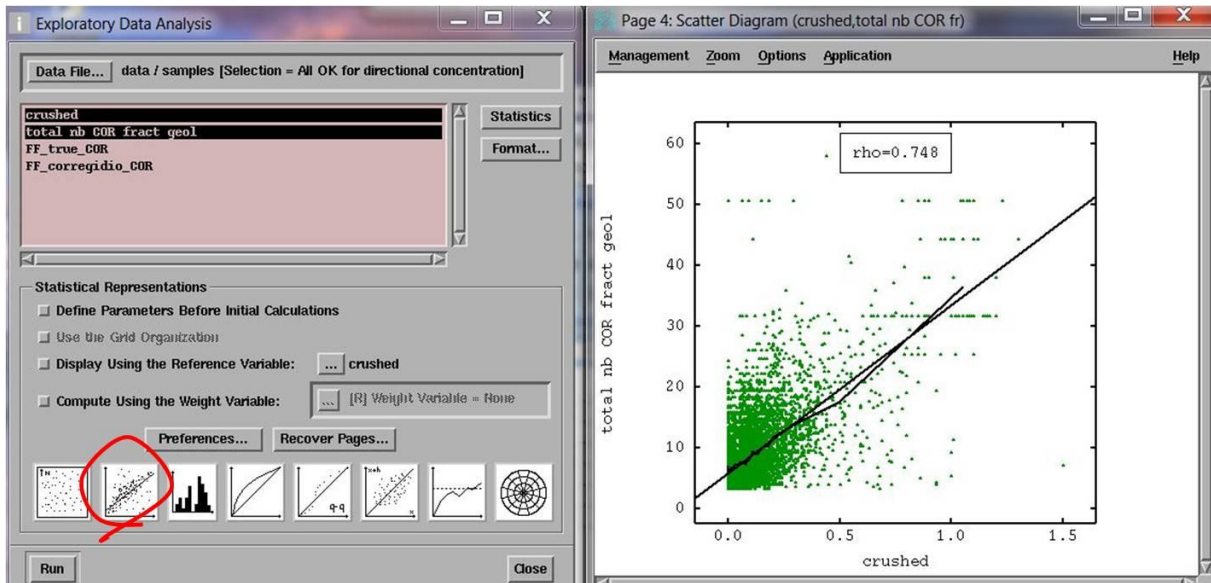

## 2 Experimental variograms

### 2.1 Bivariate calculation (intrinsic correlation verification)

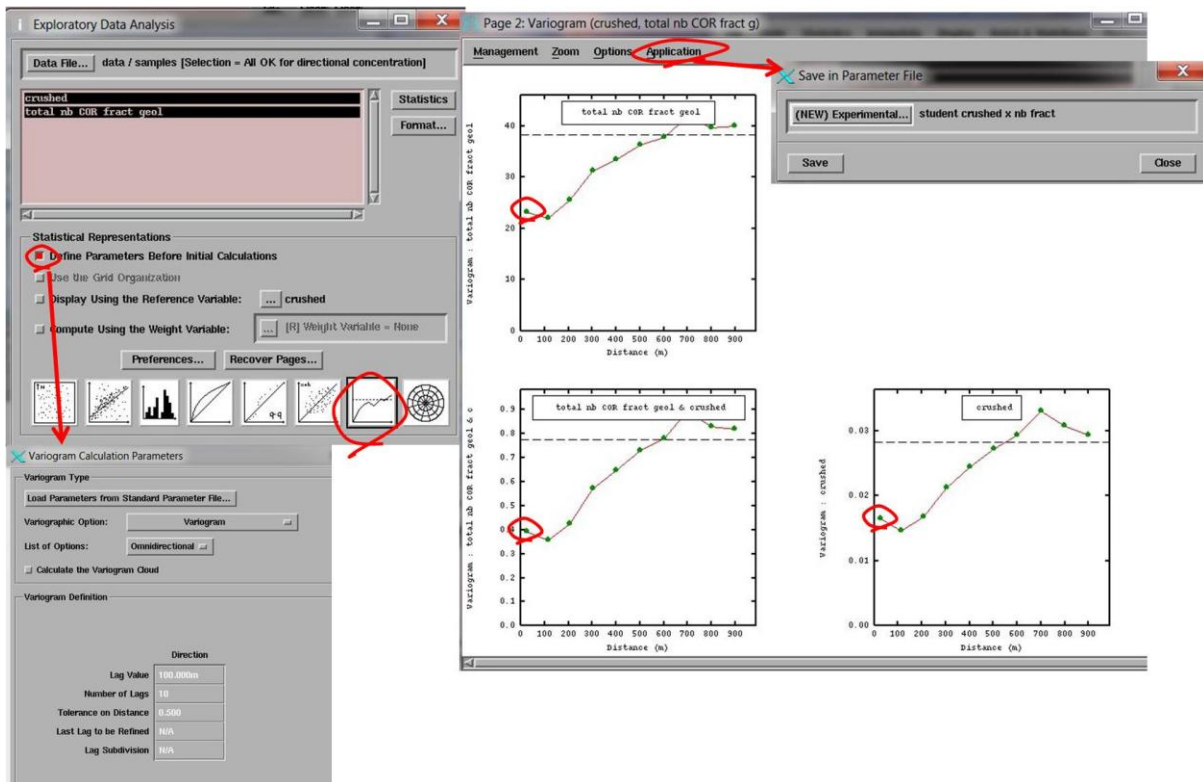

## 2.2 Monovariate calculation (independent kriging)

Exploratory Data Analysis

Data File... data / samples [Selection = All OK for directional concentration]

crushed  
total nb COR fract geol

Statistics  
Format...

Statistical Representations

Define Parameters Before Initial Calculations

Use the Grid Organization

Display Using the Reference Variable: ... crushed

Compute Using the Weight Variable: ... [R] Weight Variable = None

Preferences... Recover Pages...

Run Close

Page 3: Variogram (crushed)

Management Zoom Options Application Help

Variogram : crushed

Distance (m)

Save in Parameter File

(NEW) Experimental... teacher crushed

Save Close

Exploratory Data Analysis

Data File... data / samples [Selection = All OK for directional concentration]

crushed  
total nb COR fract geol

Statistics  
Format...

Statistical Representations

Define Parameters Before Initial Calculations

Use the Grid Organization

Display Using the Reference Variable: ... crushed

Compute Using the Weight Variable: ... [R] Weight Variable = None

Preferences... Recover Pages...

Run Close

Page 4: Variogram (total nb COR fract geol)

Management Zoom Options Application Help

Variogram : total nb COR fract geol

Distance (m)

Save in Parameter File

(NEW) Experimental... teacher Nb fract

Save Close

### 3 Variogram modelling

#### 3.1 Bivariate fitting (intrinsic correlation)

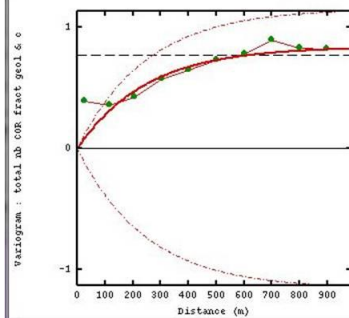
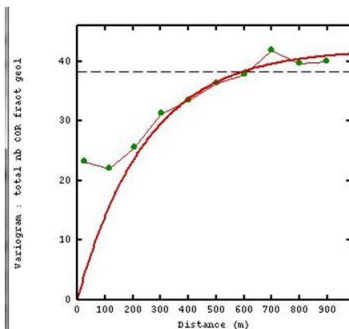
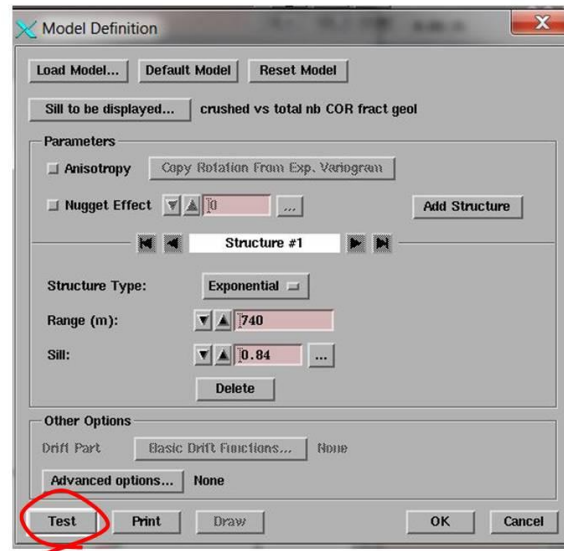

Exponential model	Crush length	Fracture Number	Crush x Fracture number
Practical Range	740 m	740 m	740 m
Sill	0.032	42	0.84

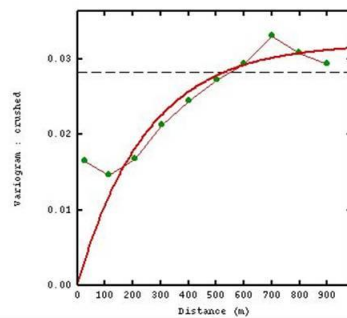

### 3.2 Monovariate fitting (independent kriging)

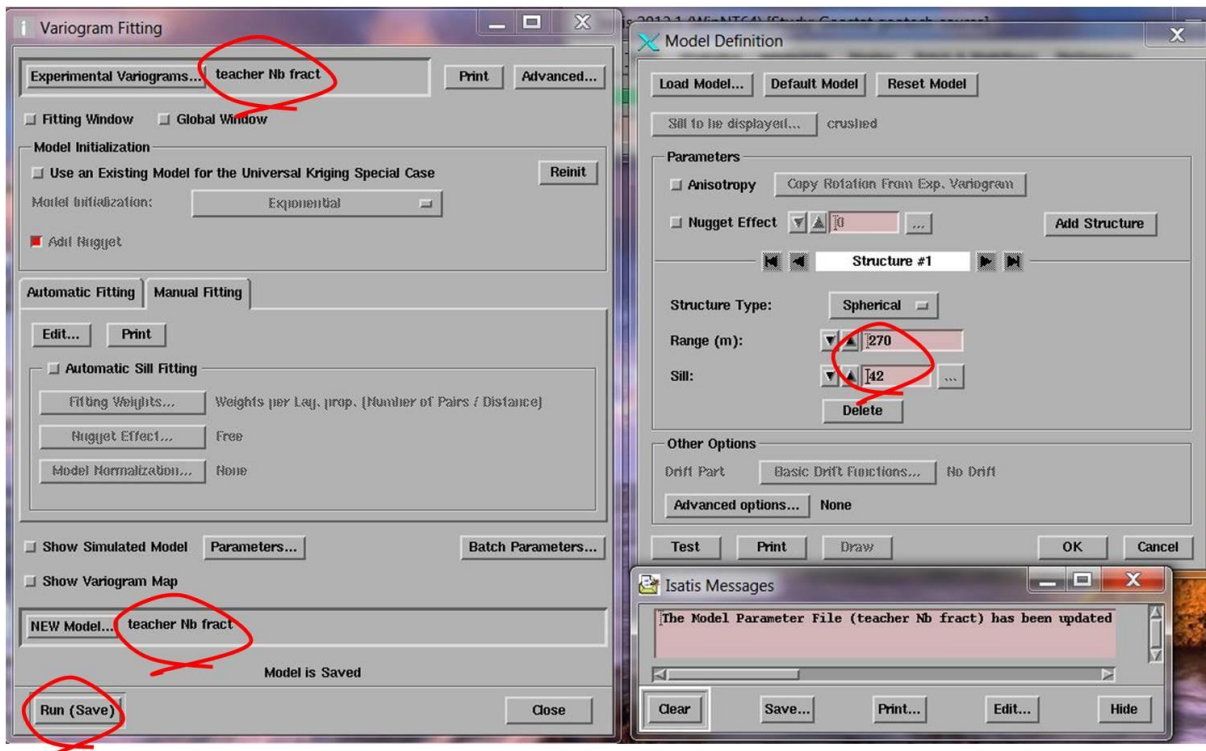
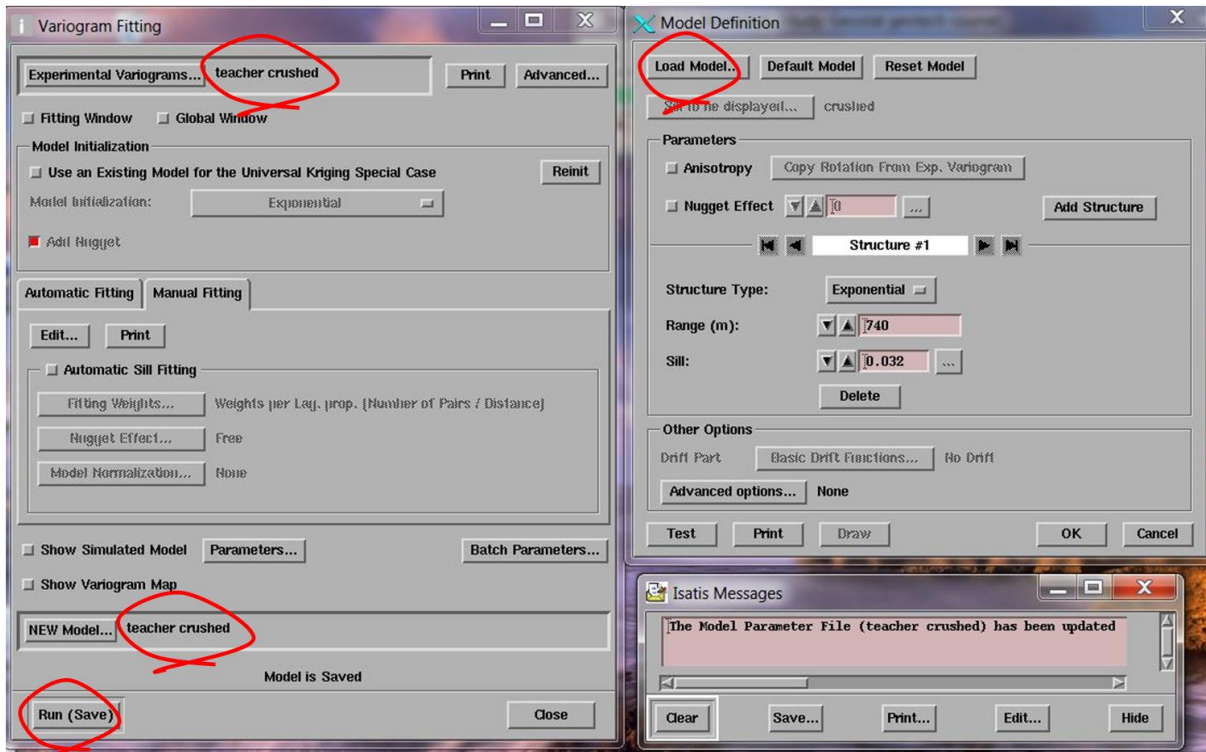

## 4 Fractures numbers and crushing estimation

The image displays two screenshots of the Isatis 2013.1 software interface. The top screenshot shows the 'Standard (Co-)Kriging' dialog box with the 'Block' calculation method selected. The 'Neighborhood Definition' dialog box is also open, showing a 'Moving' neighborhood type with search ellipsoid dimensions of 100m x 200m x 150m. The bottom screenshot shows the 'Standard (Co-)Kriging' dialog box with the 'teacher Nb fractures' model selected. The 'Isatis Messages' window is also open, displaying the kriging procedure details.

**Standard (Co-)Kriging Dialog (Top):**

- Calculation: **Block**
- Number of Variables: 1
- Maximum Number of External Drifts: 0
- Input File: data / samples [Selection = All OK for directional concentration]
- Output File: data / grid [Selection = None]
- Kriging Parameters: Model... teacher, Neighborhood... teacher

**Neighborhood Definition Dialog (Top):**

- Neighborhood Type: **Moving**
- Search Ellipsoid: Maximum Distances in the System after Rotation: U 100 m, V 200 m, W 150 m
- Use Anisotropic Distances (According to the Search Ellipsoid):
- Minimum Number of Samples: 10
- Number of Horizontal Angular Sectors: 4
- Optimum Number of Samples per Sector: 5
- Select all the Samples in the Target Cell/Block:

**Standard (Co-)Kriging Dialog (Bottom):**

- Calculation: Block
- Number of Variables: 1
- Maximum Number of External Drifts: 0
- Input File: data / samples [Selection = All OK for directional concentration]
- Output File: data / grid [Selection = None]
- Kriging Parameters: Model... **teacher Nb fractures**, Neighborhood... teacher

**Isatis Messages Window (Bottom):**

```

Kriging procedure
-----
Data File Information:
  Directory = data
  File = samples
  Selection = All OK for directional concentration
  Variable(s) = total nb COR fract geol
Target File Information:
  Directory = data
  File = grid
  Variable(s) = teacher Nb fractures
  Type = GRID (5117460 cells)
Model Name = teacher Nb fract
Neighborhood Name = teacher - MOVING

Kriging using 4 threads
Successfully processed = 1152376
Written to the disk = 5117460
CPU Time = 0:03:01 (181 sec.)
Elapsed Time = 0:01:16 (76 sec.)
    
```

## 5 Post process & FF calculation

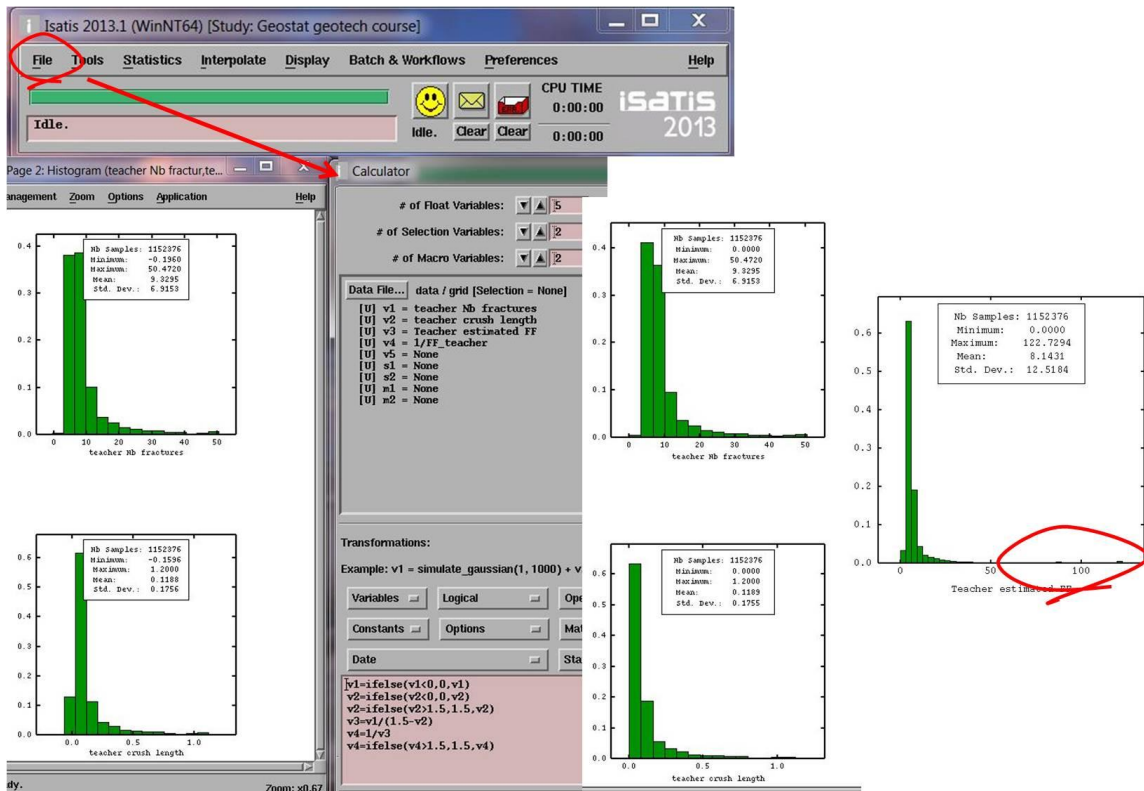

## 6 1/FF mapping

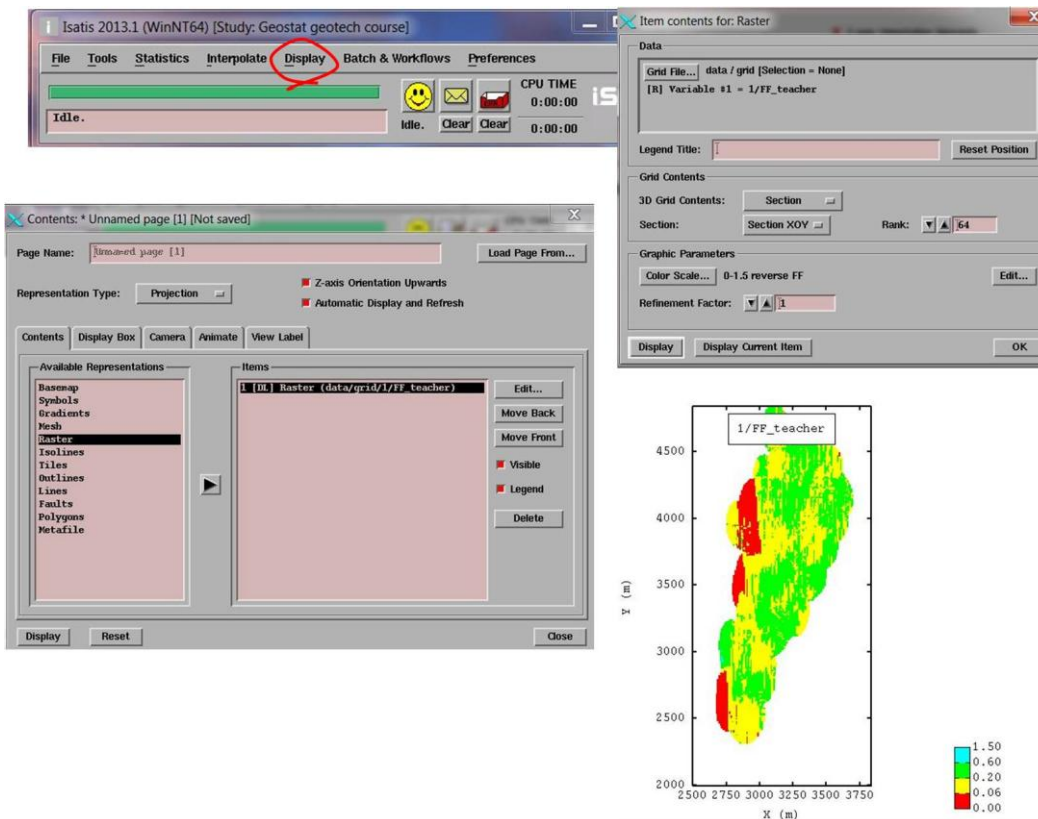

## 7 Crushing Percentage calculation & Mapping

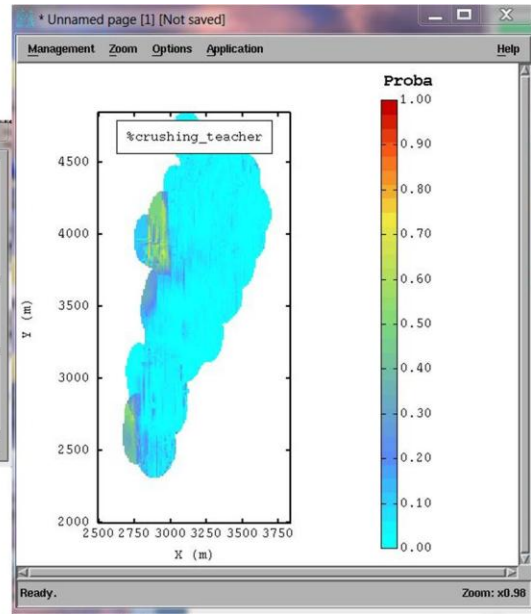
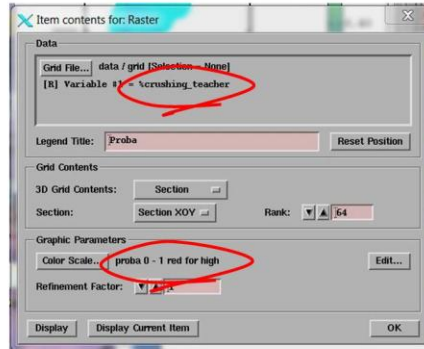
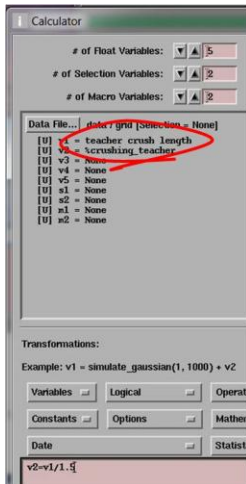

# Geostatistical Evaluation of Fracture Frequency & Crushing

(caving 2014 congress, authors draft)

S.A. Séguret MINES ParisTech, France; C. Guajardo Moreno CODELCO, Chile; R. Freire Rivera CODELCO, Chile

## Abstract

This work details how to estimate the Fracture Frequency (FF), ratio of a number of fractures divided by a sample length. The difficulty is that often, a part of the sample cannot be analysed by the geologist because it is crushed, a characteristic of the rock strength that must also be considered for the Rock Mass Rating. After analysing the usual practices, the paper describes the (geo)statistical link between fracturing and crushing and the resulting method to obtain an unbiased estimate of FF at a block or point support scale. Some concepts are introduced: "True" FF, "Crushed" FF, crushing probability and crushing proportion. The study is based on a real data set containing more than 13,000 samples. An appendix gives a very general formal demonstration on how to obtain unbiased ratio estimation.

## 1 Introduction

One of the most important attribute used in the Rock Mass Rating (RMR) is the Fracture Frequency (FF), basically the ratio of a number of fractures counted by the geologist divided by the sample length. But the calculation is not that simple because it happens often that a significant part of the sample is crushed, making the fractures counting impossible, and FF becomes the ratio of two quantities that both change from a location to another one in the deposit, making difficult its evaluation, whether at sample or block scales - in other words, this ratio is not additive (Carrasco et al. 2008). To get around this difficulty, the usual practice consists in using an additive formula that combines fractures number and crush length.

The aim of this paper is:

- Analyzing the geostatistical link between fracturing and crushing,
- Proposing an unbiased way to estimate FF,
- Introducing the concept of crushing probability.

## 2 Formalization

Let us scheme a sample to set the vocabulary (Figure 1).

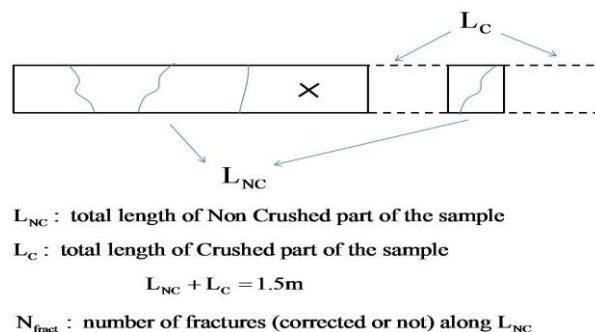

Figure 1 Scheme presenting the useful variables, Crush Length and Fractures Number

In the following, all the samples are supposed to have the same length (1.5 meter). For simplification, one will consider just one location “x” (center of gravity of the sample) for  $L_{NC}$ ,  $L_C$  and  $N_{fract}$ . The quantities  $L_{NC}$ ,  $L_C$  and  $N_{fract}$ , counted by 1.5m length, are additive and can be estimated by the basic geostatistical method called “kriging” (Matheron 1963).  $N_{fract}$  plays the role of a “fractures accumulation”, the equivalent of the “metal accumulation” in conventional mining i.e. the product of the grade by the thickness of the vein.

The quantity:

$$FF_{true}(x) = \frac{N_{fract}(x)}{L_{NC}(x)} \quad (1)$$

is the key frequency as it represents the true fractures frequency in the non-crushed part of the material. But it is not additive: when x moves in the space,  $N_{fract}(x)$  and  $L_{NC}(x)$  change and the average frequency between two measurements located at  $x_1$  and  $x_2$  is:

$$FF_{true}(x_1 \cup x_2) = \frac{N_{fract}(x_1) + N_{fract}(x_2)}{L_{NC}(x_1) + L_{NC}(x_2)}$$

This latter ratio is equal to the average of  $FF_{true}(x_1)$  and  $FF_{true}(x_2)$  only if  $L_{NC}(x_1) = L_{NC}(x_2)$ . So a direct “kriging” of  $FF_{true}(x_0)$  for any  $x_0$ , using surrounding measurements  $FF_{true}(x_i)$ , is not possible.

This is the reason why practices consist in using the formula:

$$FF_{corrected}(x) = \frac{N_{fract}(x) + aL_C(x)}{1.5} \quad (2)$$

In (2), the coefficient “a” represents an arbitrary quantity supposed to give more or less importance to crushing in comparison with fracturing ( $a=40$  in our case). By this way, the geotechnician incorporates the information given by crushing. (2) has also the advantage to combine additive quantities that can be estimated separately and then combined:

$$\hat{FF}_{corrected}(x) = \frac{N_{fract}^*(x) + aL_C^*(x)}{1.5} \quad (3)$$

In (3), the exponent “\*” denotes various estimates.

To understand what the coefficient “a” represents, let us develop (2):

$$FF_{corrected}(x) = \frac{L_{NC}(x)FF_{true}(x) + L_C(x)a}{L_{NC}(x) + L_C(x)} = \frac{L_{NC}(x)FF_{true}(x) + L_C(x)FF_{crushed}(x)}{L_{NC}(x) + L_C(x)} \quad (2')$$

Presented in this way, (2’) appears as an additive formula combining two frequencies, “a” being the one associated with crushing (now written  $FF_{crushed}$ ). This latter quantity must be at least greater than any observable  $FF_{true}$  and we will detail this point in the following.

First, let us analyse the link between fracturing and crushing.

## 2 Observation of a natural phenomenon

We start by the examination of two samples:

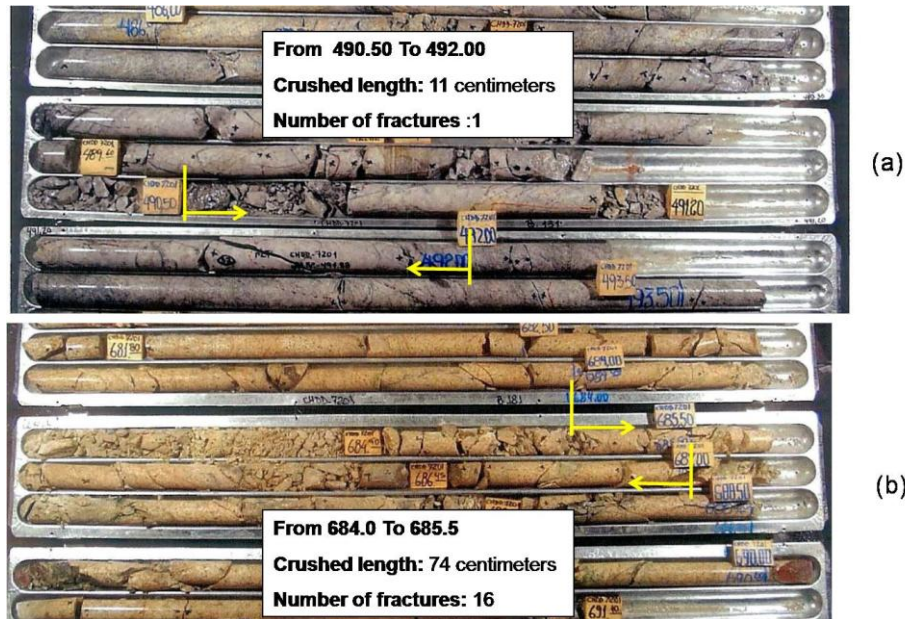

Figure 2 Two samples (a) Few crushing and fractures (b) important crushing, numerous fractures

Figure 2a presents a drill core where the crush length is only 11 cm with just one fracture in the non crushed part; figure 2b presents the contrary: crush length is important (74 cm over 1.5 m) and 16 fractures in the remaining part. Is it a particular example or is there a statistical link between  $N_{\text{fract}}$  and  $L_C$ ? We have analysed 13,000 samples (1.5 m length) coming from an underground mine in a  $1000 \times 2300 \times 1000 \text{ m}^3$  box along x, y, z. (Figure 3).

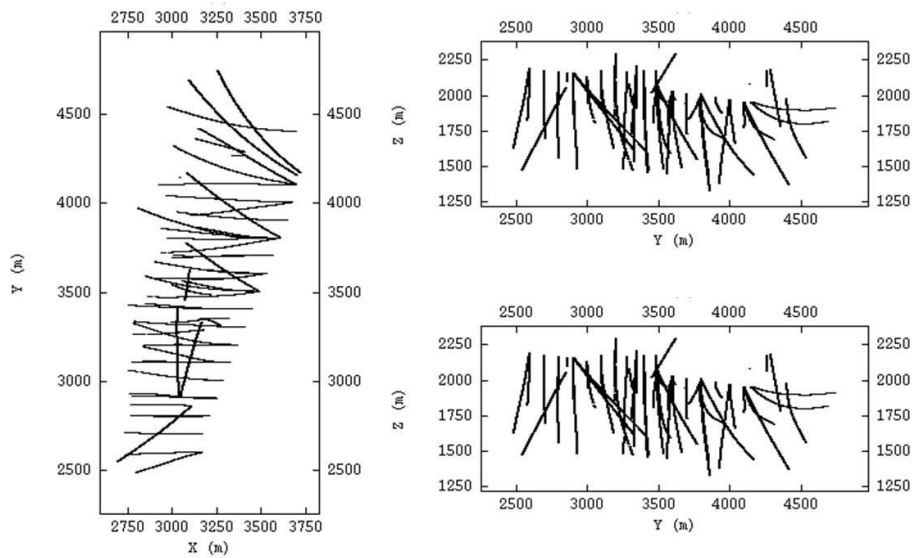

Figure 3 Planes presenting projections of the data

The scatter diagram between  $N_{\text{fract}}$  and  $L_C$  (Figure 4a) leads to mixed conclusions:

- The correlation coefficient is important (0.75),
- 70% of the population lies inside the confidence interval defined by the conditional expectation curve, the remaining part does not present significant correlation.

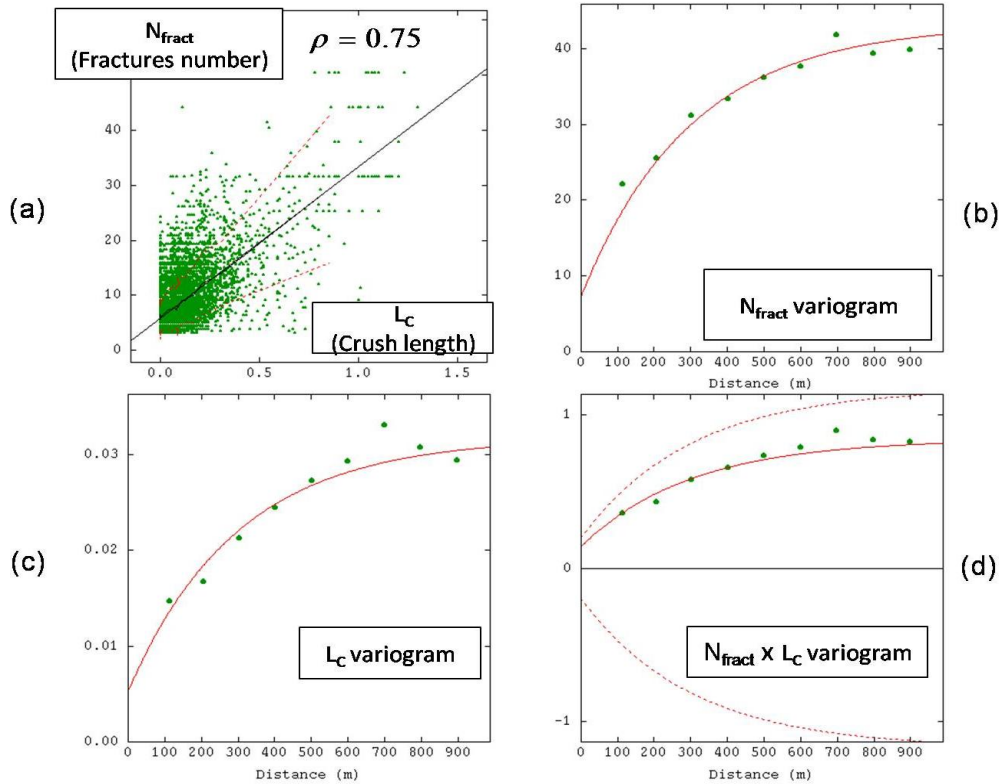

Figure 4 (a) Scatter diagram between crush length ( $L_c$ , horizontal axis) and Fractures number ( $N_{fract}$ ). Line represents the linear regression of  $N_{fract}$  against  $L_c$ , as well as the conditional expectation curve. Red dotted lines represent the standard deviation around the conditional curve. (b-c-d) Resp.  $N_{fract}$ ,  $L_c$  and  $N_{fract}$  cross  $L_c$  variograms. Points are experimental, continuous curves the intrinsic model (all the variograms are proportional)

## 4 True frequency estimation

Figures 4b, 4c and 4d present respectively the direct  $N_{fract}$  variogram (Matheron 1962, or a possible alternative calculation given by Emery 2007),  $L_c$  variogram, and their cross variogram. All these variograms can be modelled by a unique model, up to a multiplicative factor – in other words,  $N_{fract}$  and  $L_c$  are in intrinsic correlation (Wackernagel 1995).

Two important consequences result from this experimental property:

- It is not useful to use cokriging (Wackernagel 1995) for estimating  $N_{fract}$  or  $L_c$ ,
- The ratio of both estimates obtained by kriging is non biased (see Appendix).

This latter property leads immediately to the method for estimating the non additive quantity  $FF_{true}$  at a block scale  $V$  located at coordinates  $x$ :

$$FF_{true}^*(V_x) = \frac{N_{fract}^K(V_x)}{L_{NC}^K(V_x)} \quad (4)$$

In (4), exponent  $K$  denotes the estimate of the variable by kriging, using a set of around 50 surrounding samples that change when the location  $x$  changes ( "moving neighbourhood", Chilès&Delfiner 1999). The samples used for numerator and denominator must be the same to preserve the non bias of the ratio.

Figure 5a presents a map of  $\frac{1}{FF_{true}^*(V_x)}$  when  $V_x$  is sized  $10 \times 10 \times 9 \text{m}^3$ . Geotechnicians prefer the reverse of the frequency because it represents the average size of non fractured core. When this quantity is small, the strength of the rock is bad and a low RMR is associated with the block. Another consequence of intrinsic correlation between both terms of the ratio is that estimating the ratio or its reverse is the same problem. Generally, this is not the case. For example, the reverse of an additive grade is not additive.

## 2 Crushing percentage or probability

Formula (4) is a ratio of two estimations that can be used separately. When we divide the denominator by the sample length, we can obtain an unbiased and optimal estimate of the crushing proportion:

$$P_c^*(V_x) = 1 - \frac{L_{NC}^K(V_x)}{\text{sample length}} \quad (5)$$

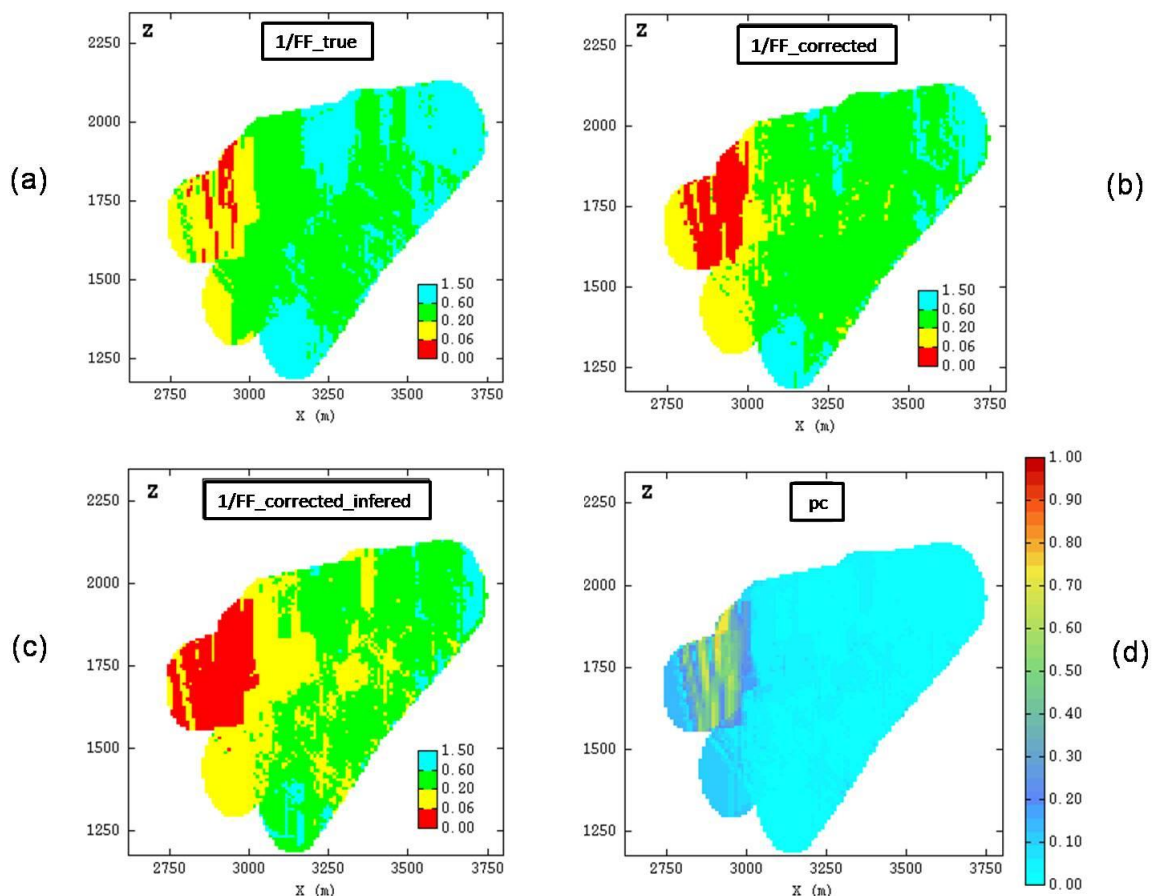

**Figure 5** (a) Map of inverse True Fracture Frequency using block kriging. (b) Map of inverse Usual Fracture Frequency that incorporates crushing estimate and arbitrary frequency for crushing equal to 40. (c) Same as (b) but with crushing frequency inferred from statistics and set to 80. (d) Crushing proportions at block scale estimated by kriging

Figure 5d shows a cross section of the result with important crushing proportions at the West of the domain, that correspond to a well known damage zone due to a major fault.

## 6 Usual formula improvement

The intrinsic correlation between crushing and fracturing leads to the optimal and unbiased estimate of formula (2) at block scale for example:

$$FF_{corrected}^*(V_x) = \frac{N_{fract}^K(V_x) + aL_C^K(V_x)}{1.5} \quad (6)$$

Figure 5b shows a cross section of  $\frac{1}{FF_{corrected}^*(V_x)}$ , a combination of figure 5a and figure 5d, with the result that the West damaged zone is reinforced by accounting for crushing proportions.

## 7 Crushing frequency inference

Development (2') shows that the coefficient "a" used in (2) and (6) plays the role of a fracture frequency associated with crushing and named  $FF_{crushed}$ . In our case, for some reasons unknown when writing this paper, this quantity was set to 40 and the question is: could this parameter be obtained experimentally?

Let us consider the scatter diagram between  $L_C$  and  $FF_{true}$  calculated using the 13,000 samples at our disposal (Figure 6).

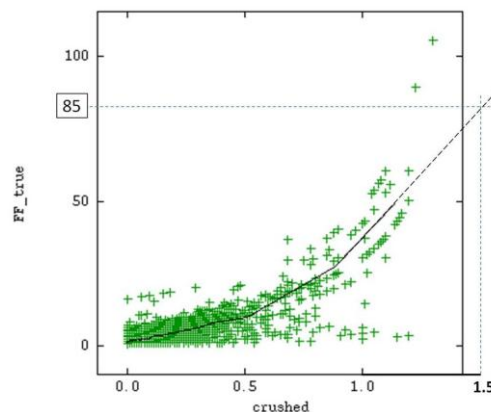

**Figure 6** Scatter diagram between crush length ( $L_C$ , horizontal axis) and  $FF_{true}$  as defined by (1). Solid line represents the conditional expectation curve; dotted segment represents a conservative extrapolation

When  $L_C$  increases,  $FF_{true}$  increases, this is a consequence of the correlation between crushing and fracturing (the number of fractures are in average more numerous when crushing length is important). The increasing rate is not linear but hyperbolic because we divide  $N_{fract}$  by a quantity that tends to zero when  $L_C$  increase.

If we suppose that:

- The crushing phenomenon appears where  $FF_{True}$  is high,
- $FF_{crushed} > FF_{true}$ ,
- On average  $FF_{crushed}$  is independent from  $L_C$ ,

then  $FF_{crushed}$  can be characterised by its average (reference to the conditional expectation curve) and must be at least equal to the limit of  $FF_{True}$  when  $L_C$  tends to 1.5m. Figure 6 shows

that  $FF_{\text{True}} = 40$  for  $L_c$  around 1m. There is still a part of the sample that is not crushed, in contrary to the previous hypothesis and  $FF_{\text{crushed}}$  must be at least greater than the maximum of  $E[FF_{\text{true}}|L_c]$  we can calculate, here 50 at  $L_c = 1.14\text{m}$ . If we make a crude linear extrapolation of the curve we obtain, for  $L_c = 1.5\text{m}$  :

$$FF_{\text{crushed}} > FF_{\text{true}} = 85$$

As every extrapolation, this result is extremely sensitive to the hypothesis on the non linear regression modeling. The mapping of the Fracture Frequency obtained when we replace 45 by 85 in (2) is presented in figure 5c. Compared to the map using the traditional formula (Figure 5 b), the West damage zone is reinforced because the influence of crushing is multiplied by more than two.

## 8 Conclusions

Analysis of usual practices and properties of the two variables involved in the Fracture Frequency – the Crush length and the Fracture number – does not require including both quantities in a single arbitrary formula. Analysis of a data set showed that both variables are statistically highly correlated as well as spatially and they share the same variogram. This circumstance makes possible to estimate directly the real interesting quantity that is the ratio of fractures number divided by the sample length really analysed and shortcuts the lack of additivity of this ratio. The resulting estimate is unbiased, a basic requirement when evaluating a quantity.

On the other hand, the crushing phenomena must be estimated separately, giving a crushing proportion (at block scale) or a crushing probability (at point support scale) that must be incorporated in RMR in the same way as FF and other geotechnical attributes.

All these possibilities depend directly on the mutual behaviour of Fractures number and Crush length and any study on the subject should start by the geostatistical analysis of these two variables. A more detailed analysis of their link, and another case study, that will be published in the next future, showed that the present observed correlation is not due to hazard: fracturing sometime contributes to crushing, sometime not, depending on the mutual organization of the fractures. Finally, with such studies, we evaluate the mechanical properties of the rock.

## Acknowledgement

The authors would like to acknowledge Sergio Fuentes Sepulveda, Vice President of the Projects Division of CODELCO, Chile, and his company, for their strong support in the implementation of good geostatistical practices along the copper business value chain, as well as anonymous reviewers who greatly contributed to improving the quality of the manuscript.

## References

The authors did not find any reference concerning Fracture Frequency estimation in Geostatistics which essentially focus on fracture network characterization and simulation (Chiles 1999). They notice some papers mentioning the use of Artificial Neural Network (Fitzgerald & Al 1999) and crushing phenomena is never studied as a Regionalized Variable.

Matheron, G 1962, 'Traité de Géostatistique Appliquée', Tome I, Mémoire du Bureau de Recherche Géologique et Minières, No 14, Editions Technip, Paris, France.

Matheron, G 1963, 'Principles of Geostatistics', Economic Geology, Vol. 58, pp. 1246-1266.

Rivoirard, J 1984, 'Le comportement des poids de krigeage', doctoral thesis, E.N.S. des Mines de Paris.

Wackernagel, H 1995, 'Multivariate Geostatistics', Springer, Berlin.



Chilès, J.P., Delfiner, P 1999, 'Geostatistics. Modeling Spatial Uncertainty', Wiley, 703 p.

Chilès, J.P., G. de Marsily, 1999, 'Stochastic models of fracture systems and their use in flow and transport modeling', in Flow and Contaminant Transport in Fractured Rock, eds. Academic Press, San Diego, Ca, Chapter 4, pp. 169-236.

Fitzgerald, E. M., Bean, C. J., Reilly, R., 'Fracture-frequency prediction from borehole wireline logs using artificial neural networks', Geophysical Prospecting Journal, volume 47, Number6, pp. 1031-1044.

Emery, X 2007, 'Reducing fluctuations in the sample variogram, Stochastic Environmental Research and Risk Assessment, 21(4),pp.391-403.

Carrasco, P., Chilès, J.P., Séguret, S.A. 2008, 'Additivity, Metallurgical Recovery, and Grade', in: Emery, X. (ed) Proceedings of Geostatistics-the eighth international Geostatistics Congress,vol. 1, pp. 237-246.