



HAL
open science

Modelling and control of a hybrid renewable energy system to supply demand of a green-building

Hanane Dagdougui, Riccardo Minciardi, Ahmed Ouammi, Michela Robba, Roberto
Sacile

► To cite this version:

Hanane Dagdougui, Riccardo Minciardi, Ahmed Ouammi, Michela Robba, Roberto Sacile. Modelling and control of a hybrid renewable energy system to supply demand of a green-building. 5th Biennial Conference of the International Environmental Modelling and Software Society: Modelling for Environment's Sake, iEMSS 2010, Jul 2010, Ottawa, ON, Canada. pp.972-979 - ISBN: 978-88-903574-1-1. <hal-00686416>

HAL Id: hal-00686416

<https://minesparis-psl.hal.science/hal-00686416v1>

Submitted on 10 Apr 2012

HAL is a multi-disciplinary open access archive for the deposit and dissemination of scientific research documents, whether they are published or not. The documents may come from teaching and research institutions in France or abroad, or from public or private research centers.

L'archive ouverte pluridisciplinaire **HAL**, est destinée au dépôt et à la diffusion de documents scientifiques de niveau recherche, publiés ou non, émanant des établissements d'enseignement et de recherche français ou étrangers, des laboratoires publics ou privés.



HAL Authorization

Modelling and control of a hybrid renewable energy system to supply demand of a green-building

H. Dagdougui^{a,b}, R. Minciardi^a, A. Ouammi^{a,c}, M. Robba^a, R. Sacile^a

^aDepartment of Communication, Computer and System Sciences (DIST), University of Genova, Italy.

^bMINES ParisTech, CRC, Sophia Antipolis Cedex, France.

^cEnergetic Laboratory, Sciences Faculty, Abdelmalek Essaadi University,
Tétouan, Morocco

Abstract: Renewable energy sources are an “indigenous” environmental option, economically competitive with conventional power generation where good wind and solar resources are available. Hybrid plants can help in improving the economic and environmental sustainability of renewable energy systems to fulfil the energy demand. The aim of this paper is to present the architecture of a Decision Support System (DSS) that can be used for the optimal energy management at a local scale through the integration of different renewable energy sources. The integrated model representing a hybrid energy generation system connected to the grid is developed. It consists of PV and solar thermal modules, wind turbine and biomass plant. Moreover, a framework is presented for the optimization of the different ways to ensure the electrical and thermal energy demand of the microgrid as well as the water demand, with specific reference to two main cases for the real time energy optimal control: the presence/absence of a storage system. Finally, the optimization model has been applied to a case study.

Keywords: DSS, optimization, wind energy, PV, smart grid.

1. Introduction

The sustainable security of energy supply, led both developed and developing countries to make and implement new policies to improve efficiency in energy consumption, to adopt new alternatives like renewable energy systems. To face the economic, social, technological and environmental challenges, the need for energy conservation as well as for developing renewable technologies becomes ever more critical. As reported by Juan et al. [2010], in the EU and US, buildings energy consumption has even exceeded the energy consumption of the industrial and transportation sectors. Renewable energy utilization is one of the most important aspects of green buildings. The wind and solar energy are freely available and environmental friendly. One common disadvantage of these resources, is their unpredictable behaviour, in addition, the variation of these sources may not match with the time distribution demand (Yang et al [2008]). Furthermore, the wind energy systems may not be technically viable at all sites because of low wind speeds and being more unpredictable than solar energy. As to solve this drawbacks, the complementary combination of each component characteristic may lead to enhancement of system efficiency and reliability. In addition, combined utilization of these renewable energy sources are therefore becoming increasingly attractive and are being widely used as alternative of oil-produced energy (Nema et al. [2009]). Hybrid renewable energy systems are becoming popular for remote area power generation applications due to advances in renewable energy technologies and subsequent rise in prices of petroleum products, and due to the possibility of attenuating fluctuations in produced power. Economic aspects of these technologies are sufficiently promising to include them in developing power generation capacity for developing countries (M.K. Deshmukh and S.S. Deshmukh [2008]). Hybrid systems can be considered as a reasonable solution, capable to support systems that cover the energy demands of both stand-alone and grid connected consumers. Commonly, it consists of a mix of two or more energy sources used jointly to provide increased system efficiency as well as greater balance in energy supply. In literature, several papers have studied the design and planning of hybrid renewable energy systems (for example: Paska et al. [2009]; Ashok [2007]; Ekren and Yetkin Ekren [2008]). The aim of this paper is to present the architecture of a Decision Support System (DSS) that can be used for the hourly energy management of a mix of renewable energy systems. Specifically, an integrated model representing a hybrid energy generation system (characterized by solar plate collector, PV, biomass, wind and battery storage) connected to the grid is developed. The approach is based on mathematical modelling of each component, then an optimization problem is solved in order to better manage and control the energy flow so to ensure reliable supply of demand.

2. The system model

The hybrid energy generation system for a general building connected to the electrical network (that is considered in this work) is reported in Figure 1. This hybrid system consists of one PV module, one wind turbine, one biomass plant, one solar flat collector, and one battery to store electricity. The optimization of such system aims to generate energy satisfying the demands in real time (i.e., heating demand, electrical demand and water demand) thus taking into account the available renewable energy resources in each time interval. The flat plat collector and biomass plant are uniquely used to ensure heating demand. Either energy produced by the wind turbine or the energy produced by the PV module can be directly used to satisfy a part of the electrical demand as well as the water demand through pumping, and/or can contribute to supply the heating demand. The electricity surplus from wind turbine and the PV module can be sent to the storage battery or/and sold to the network. The battery storage system can receive electrical energy from PV module and wind turbine and can provide free energy for heating, electricity, and pumping needs in cases of deficit in electricity. Furthermore, the network connection offers the possibility to purchase electricity in case of failure of the storage system. In particular, the following entities are defined:

E_X^t : The output energy produced from the wind turbine/PV/Biomass/FPC [kWh] in time interval $(t, t+1)$, $t=0, \dots, T-1$;

Where index X designates the renewable energy system [WT, PV, B, FPC]

$E_{Y,h}^t$: The energy provided from renewable energy system [kWh] for heating in time interval $(t, t+1)$;

Where index Y indicates [WT, PV, B, FPC, Net]

$E_{Y,e}^t$: The energy provided from the renewable energy system and the grid [kWh] for electric supply [kWh] in time interval $(t, t+1)$;

Where index Y indicates [WT, PV, Net]

$E_{Y,p}^t$: The energy from the renewable energy system and the grid [kWh] for supply electricity for pumping water in time interval $(t, t+1)$;

$E_{Z,Net}^t$: The surplus produced from wind/PV [kWh] sent to the network in time interval $(t, t+1)$;

Where index Z indicates [WT, PV]

\tilde{E}_{Net}^t : The overall energy that is sent to the network from wind and PV module [kWh] in time interval $(t, t+1)$;

\hat{E}_{Net}^t : The overall energy [kWh] that is taken from the network in time interval $(t, t+1)$;

$\Delta E_{Net,eff}^t$: The overall energy effectively sent to the network [kWh] in time interval $(t, t+1)$;

$E_{Z,b}^t$: The energy from wind turbine/PV that is sent to the battery [kWh] in time interval $(t, t+1)$;

Q_w^t : The amount of water pumped [m^3/h] in time interval $(t, t+1)$;

CH_e^t : energy provided from the battery to the electricity [kWh] in time interval $(t, t+1)$, $t=0, \dots, T-1$;

CH_h^t : energy provided from the battery to the heating system [kWh] in time interval $(t, t+1)$;

CH_p^t : energy provided from the battery to the pumping [kWh] in time interval $(t, t+1)$;

CB^t : the level of battery charge [kWh] at time instant t , $t=0, \dots, T-1$.

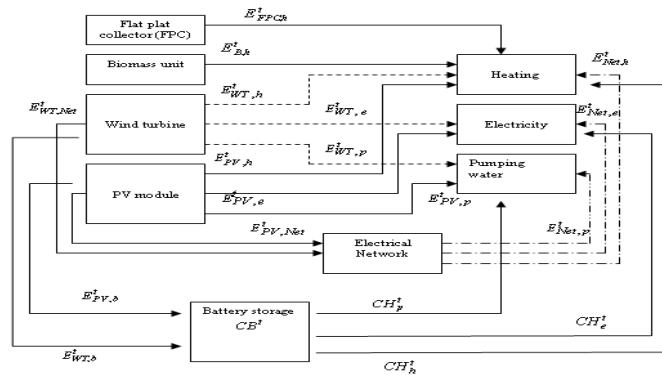

Figure 1. The considered hybrid system

2.1 Energy from the wind turbine

The power output from the wind turbine unit is expressed as a function of the wind speed, In fact, a linear wind model [16] assumes a linear (affine) dependence (within the interval $[v_c, v_r]$) of the wind turbine power output, P_{wt}^t , on the current wind speed at the hub height v^t , $t=0, \dots, T-1$, being T the time horizon in hour. The following equation is used to simulate the electrical power output of the wind turbine (Notton et al. [2001]): ,

$$P_{wt}^t = \begin{cases} 0 & v^t < v_c \\ p_r \frac{v^t - v_c}{v_r - v_c} & v_c \leq v^t \leq v_r \\ p_r & v_r \leq v^t \leq v_f \\ 0 & v^t > v_f \end{cases} \quad t=0, \dots, T-1 \quad (1)$$

where p_r is the rated electrical power, v_c is the cut in wind speed, v_r is the rated wind speed, and v_f is the cut off wind speed.

In general, the wind speed measurements are given at a height different than the hub height of the wind turbine, the following equation is used to evaluate the wind speed at the desired height (Rodolfo et al. [2008]):

$$v^t = v_{data}^t \frac{\ln(H_{hub}/z_0)}{\ln(H_{data}/z_0)} \quad t=0, \dots, T-1 \quad (2)$$

Where v^t is the wind speed at the height of the hub, H_{data} is the height of the measurement, H_{hub} is the hub height, z_0 is the surface roughness length, and v_{data}^t is the wind speed at the height of the measurements.

2.2 Energy from the PV module

The output power generated from the PV module, with respect to the solar radiation, can be calculated using the following formula (Hocaoglu et al. [2009]):

$$P_{pv}^t = S_{pv} \eta_{pv} p_f \eta_{pc} G^t \quad t=0, \dots, T-1 \quad (3)$$

where S_{pv} is the solar cell array area, η_{pv} is the module reference efficiency, p_f is the packing factor, η_{pc} is the power conditioning efficiency, and G^t is the hourly irradiance.

2.3 Energy from the biomass heating plant

Energy provided by the biomass heating plant depends on the used biomass quantity u_t [$m^3 \text{ hour}^{-1}$], the biomass volumetric mass, VM [$kg \text{ m}^{-3}$] (i.e., the ratio between the dry mass [kg] and the volume [m^3]), the lower heating value, LHV [$MJ \text{ kg}^{-1}$]. The LHV assumes that the latent heat of vaporization of water in the fuel and the reaction products is not recovered. Then, it can be calculated once higher heating value (HHV) and moisture content (MC) are known. The HHV is the total energy release in the combustion with all of the products at 273 K in their natural state when water has released its latent heat of condensation. In the considered work, the HHV is evaluated from the basic data analysis of biomass. The biomass MC [%] represents the water amount present in the biomass and it can be expressed as a percentage of the dry weight. As regards production plant, the plant is supposed to operate at the maximum productivity level. The following equation states that the plant developed energy E_B^t [kWh]:

$$E_B^t = 0.2778 \eta_{bh} LHV u_t VM \quad t=0, \dots, T-1 \quad (4)$$

Where η_{bh} is the plant efficiency and 0.2778 is a conversion factor.

2.4 Energy from the flat plate collector

The useful thermal energy extracted from the water collector depends on the instantaneous incident solar irradiation, the plate area, and its efficiency (El Fadar et al [2009]). That is,

$$E_{FPC}^t = \eta_{fpc} A_{fpc} G^t \Delta t \quad t=0, \dots, T-1 \quad (5)$$

Where η_{fpc} is the efficiency of the solar flat plate collector, A_{fpc} [m^2] is the area and G^t [kW/m^2] is the solar irradiation.

2.5 Produced thermal and electrical energy

The hourly energy that can be used in time interval for heating, E_h^t , is expressed by

$$E_h^t = E_{WT,h}^t + E_{PV,h}^t + E_{FPC,h}^t + E_{B,h}^t + E_{Net,h}^t + CH_h^t \quad t=0,\dots,T-1 \quad (6)$$

The hourly electrical energy E_e^t that can be used in time interval is expressed by:

$$E_e^t = E_{WT,e}^t + E_{PV,e}^t + E_{Net,e}^t + CH_e^t \quad t=0,\dots,T-1; \quad (7)$$

The hourly energy E_p^t that can be used in time interval for pumping water is given by:

$$E_p^t = E_{WT,p}^t + E_{PV,p}^t + E_{Net,p}^t + CH_p^t \quad t=0,\dots,T-1; \quad (8)$$

The amount of pumped water is proportional to the energy used for this purpose, that is

$$Q_w^t = \frac{E_p^t}{\rho g h} \eta_{ps} \quad t=0,\dots,T-1$$

Where ρ is the water density [kg m^{-3}], g is the gravity constant acceleration [m s^{-2}]; η_{ps} is the pumping system efficiency and h is the height of pumping.

2.6 Energy flow exchange with the network:

The energy that is sent to the network is composed by the surplus produced by the wind turbine and the surplus produced by the PV module, i.e.,

$$\tilde{E}_{Net}^t = E_{WT,Net}^t + E_{PV,Net}^t \quad t=0,\dots,T-1 \quad (10)$$

The energy that is taken from the network is given by

$$\hat{E}_{Net}^t = E_{Net,h}^t + E_{Net,e}^t + E_{Net,p}^t \quad t=0,\dots,T-1 \quad (11)$$

The energy productions by the wind turbine and the PV module in each time interval can be used for different supply purposes: electrical demand, heating demand, water demand, sent to the battery or sold to the network. Thus, the following equations hold

$$E_{WT}^t = E_{WT,h}^t + E_{WT,e}^t + E_{WT,p}^t + E_{WT,Net}^t + E_{WT,b}^t \quad t=0,\dots,T-1 \quad (12)$$

$$E_{PV}^t = E_{PV,h}^t + E_{PV,e}^t + E_{PV,p}^t + E_{PV,Net}^t + E_{PV,b}^t \quad t=0,\dots,T-1 \quad (13)$$

Instead, as regards biomass and flat collector plant, the produced energy can be less or equal to the available potential. In fact, biomass may not be used (also because if it is summer heating does not work and heating cannot be sent to the network), and water for heating passing through the plate collector may be stopped. This implies the following relations:

$$E_{B,h}^t \leq E_B^t \quad t=0,\dots,T-1 \quad (14)$$

$$E_{FPC,h}^t \leq E_{FPC}^t \quad t=0,\dots,T-1 \quad (15)$$

Finally, $E_{PV,Net}^t$ and $E_{WT,Net}^t$ are known because they are the surplus of electrical energy. That is,

$$E_{PV,Net}^t = \max\left(0, E_{PV}^t - E_{PV,p}^t - E_{PV,e}^t - E_{PV,h}^t - E_{PV,b}^t\right) \quad t=0,\dots,T-1 \quad (16)$$

$$E_{WT,Net}^t = \max\left(0, E_{WT}^t - E_{WT,p}^t - E_{WT,e}^t - E_{WT,h}^t - E_{WT,b}^t\right) \quad t=0,\dots,T-1 \quad (17)$$

2.7 The battery storage state equation

The battery works as an inventory for the electrical energy that can, in this way, be stored. Specifically, a state equation for the battery storage can be formalized. That is,

$$CB^{t+1} = CB^t + E_{WT,b}^t + E_{PV,b}^t - CH_p^t - CH_h^t - CH_e^t \quad t=0,\dots,T-1 \quad (18)$$

3. The optimization problem

The decision variables of the optimization problem are $E_{WT,h}^t, E_{PV,h}^t, E_{FPC,h}^t, E_{B,h}^t, E_{Net,h}^t, E_{WT,e}^t, E_{PV,e}^t, E_{Net,e}^t, E_{WT,p}^t, E_{PV,p}^t, E_{Net,p}^t, CH_e^t, CH_h^t, CH_p^t$, while CB^t are the state variables of the overall system.

The objective function (to be minimized) is characterized by the weighted sum of the deviation from the various demands., as well two terms to be maximized related to the energy sent to the storage system and the electrical network. That is,

$$\begin{aligned}
 Z = & \sum_{t=1}^{T-1} \left(E_{WT,h}^t + E_{PV,h}^t + E_{FPC,h}^t + E_{B,h}^t + E_{Net,h}^t + CH_h^t - E_{Dh}^t \right)^2 + \\
 & \alpha \sum_{t=1}^{T-1} \left(E_{WT,e}^t + E_{PV,e}^t + E_{Net,e}^t + CH_e^t - E_{De}^t \right)^2 + \\
 & + \beta \sum_{t=1}^{T-1} \left(\frac{E_{WT,p}^t + E_{PV,p}^t + E_{Net,p}^t + CH_p^t}{\rho gh} \eta_{ps} - Q_{Dw}^t \right)^2 - \chi \sum_{t=1}^{T-1} \tilde{E}_{Net}^t - \varepsilon \sum_{t=1}^{T-1} CB^t
 \end{aligned} \quad t=0,\dots,T-1 \quad (19)$$

Where α , β , χ , and ε are weighting factors, and E_{Dh}^t , E_{De}^t , Q_{Dw}^t are respectively the effective heating, electricity and water demands.

The constraints of the optimization problems are represented by equations reported in section 2. Moreover, there is a constraint related to the battery capacity. That is,

$$CB^t \leq C \max \quad t=0,\dots,T-1 \quad (20)$$

where $C \max$ is the size of the battery.

The problem is here solved using mathematical programming techniques through a commercial optimization package. Dynamic programming could also be used to reduce the overall problem complexity, decomposing it in sub-problems. In the case of absence of battery energy storage, since there are no state equations and available energy varies in each time interval, the optimization problem can be run at each time interval in a separated way.

In the following, the optimization problem is solved for a specific case study, in which there is not the presence of the battery storage (thus, the variables related to the battery storage are known and equal to zero).

4. Application to a case study

The proposed DSS has been tested using the real data obtained from Capo Vado site, which is the windiest site in the region of Liguria, in Italy (Ouammi et al [2010]). The data of the First November 2008 have been used. They consist of the hourly wind speed, recorded at the height of 10m, and hourly solar irradiation (see figure 2). The optimization problem has been solved using the optimization tool Lingo (www.lindosystems.org).

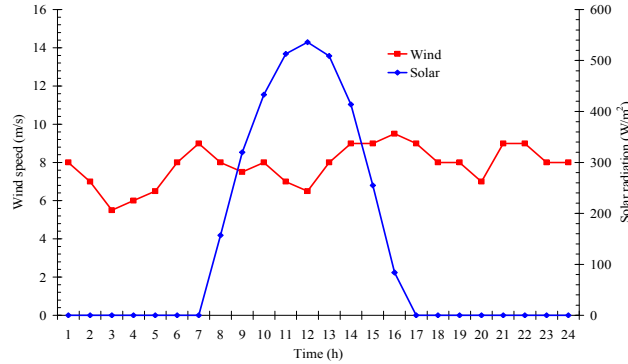

Figure 2: Hourly wind speed and solar radiation in the site of Capo Vado

The wind model described by equations above has been applied to the specific case study, using the wind turbine G-3120 35 kW with the following parameters www.endurancewindpower.com: $v_c=3.5$ [m/s], $v_r=11$ [m/s], $v_f=25$ [m/s], $P_r=35$ [kW], $H_{hub}=30.5$ [m], $H_{data}=10$ [m], $z_0=0.03$ [m]. For the PV module, the features that has been used consist of: $S_{pv}=100$ m², $\eta_{pv}=0.11$, $\eta_{pc}=0.86$ and $P_f=0.9$.

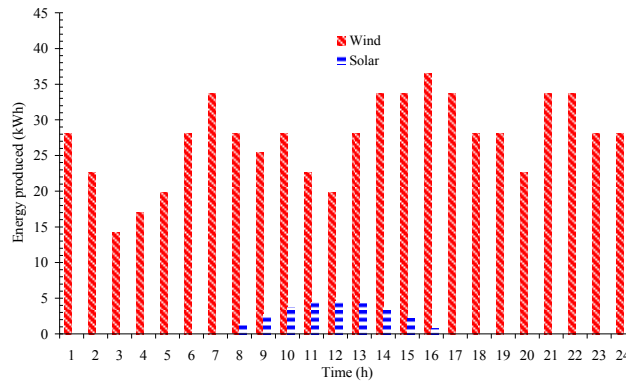

Figure 3: Hourly energy produced during the first November 2008.

Figure 3 shows the hourly energy produced by the wind turbine, as well as the hourly energy produced by the PV module. In fact, the figure shows that the energy range produced by the wind turbine is included between 14.3 kWh at 3:00 and a maximum value of 36.5 kWh at 16:00. However, for the solar module, the energy production reaches its maximum 4.5 kWh at 12:00. It seems that the energy production coming from the wind turbine is higher than the energy produced from the PV module. This fact is mainly due to the high wind speed in November and the low solar radiation.

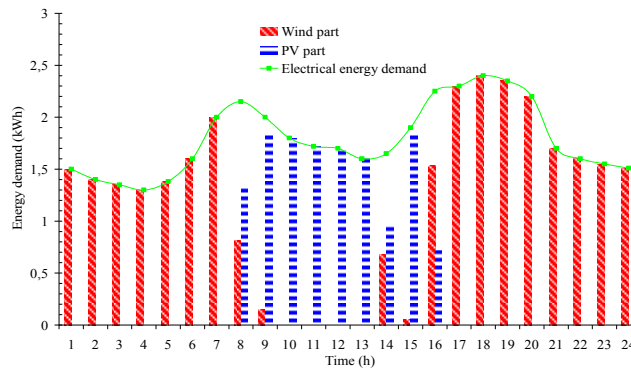

Figure 4: Optimal electrical energy control

The optimal energy management that is addressed to satisfy the electrical energy needs of the household is displayed in Figure 4. The electrical energy demand reaches its higher hourly peak value of 2.4 kWh at 18:00 and a minimum of 1.3 kWh at 04:00. The hourly periods have been defined throughout the day: period A ($1 < t < 8$), period B ($8 \leq t < 17$) and period C ($17 \leq t \leq 24$). During period A and C, the electrical energy needs were totally provided by the wind turbine owing to the absence of the solar radiation. During the period B, both the wind turbine and solar PV module provide sufficient energy to meet the hourly electrical energy demand of the household with a dominant participation of the solar PV module.

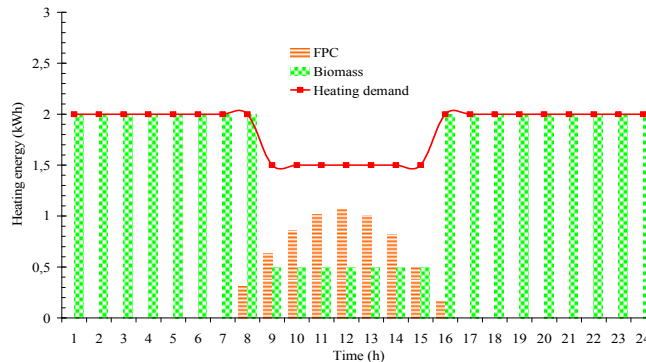

Figure 5: Optimal heating energy control

Figure 5 shows the contribution of biomass unit and the flat plate solar collector through the daily hours, we mention that these systems are responsible in addition to energy given by PV and wind turbine to provide a part of

heating energy needs. In one hand, it can be shown that the energy delivered by the biomass system goes between a maximum that equals to 2 kWh and a minimum equal to 0.5 kWh. On the other hand, as regard the flat plate solar collector (FPSC), the energy produced from the sum goes directly to contribute in the satisfaction of the heating energy requirements, reaches a maximum of 1kWh at 12:00. We must notate that in this typical day, no wind and PV contribution is remarked for the supply of heat needs, the Biomass as well as the FPSC are the only one that furnish the heating needs of the household,

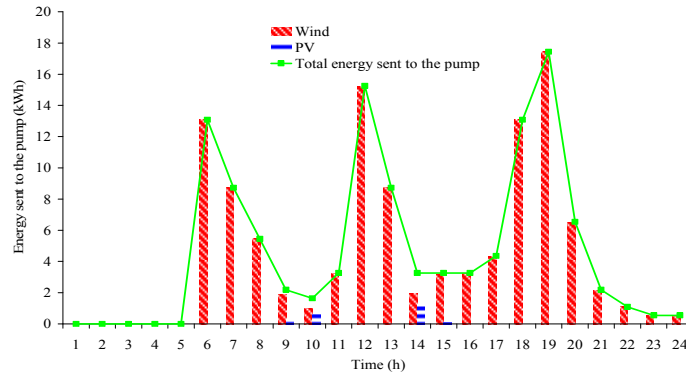

Figure 6: Optimal control of the water demand

As regard the water demand, its availability is depending on the working pumps which must use the electrical energy coming from the wind and PV systems in order to pump water. As displayed by Figure 6, three peaks are perfectly met during the hours of the day 6:00AM, 12:00PM and 19:00 PM, thus mainly using electrical energy from the wind turbine. By comparing energy produced by each system, it appears that the wind turbine provides the higher amount of energy. This behavior is mainly due to the high wind potential available in Capo Vado site compared with solar energy.

In order to ensure the sustainability of the hybrid system, and addressing the mismatch between the intermitencies of wind and solar irradiation on one part and of demand in another part, the system presented in this paper integrates both: an internal storage system and a connection with the electrical grid, the main goal of implementing these two systems are:

- Once the electricity generated by the wind and the solar modules exceed the total demand of the household, electricity will be “stored” at the battery and/or “sold” to the network.
- Once the battery is fully charged, the electricity excess will be sold directly to the electrical Network.
- Once the electricity generated by the wind, solar modules, biomass and FPSC is not sufficient, the deficit of electricity and/or the heating and/or pumping water system will be compensated by the electricity cumulated in the battery or purchased from the grid.

The choice between these two electrical systems (battery and Network) will be guaranteed by the objective function and its constraints, thus by making the system more reliable as possible.

The cumulative storage battery level can be well seen from Figure 7, in fact, the battery has a large transitory regime until it reaches its higher storage value. This storage is effectuated during the day and at each hour, thus assuming that the battery was empty at $t=0$ which correspond to the initial time. In figure 8, the hourly electricity sold to the network is displayed. It can be shown that this transfer occurs during all the hours of the day, where the wind turbine is the one that send the excess of energy.

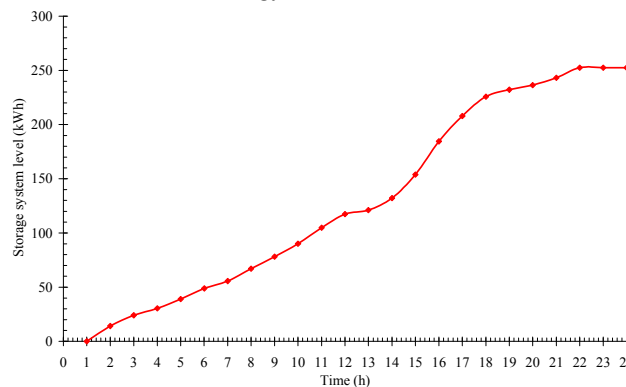

Figure 7: wind and solar energy sent to the battery

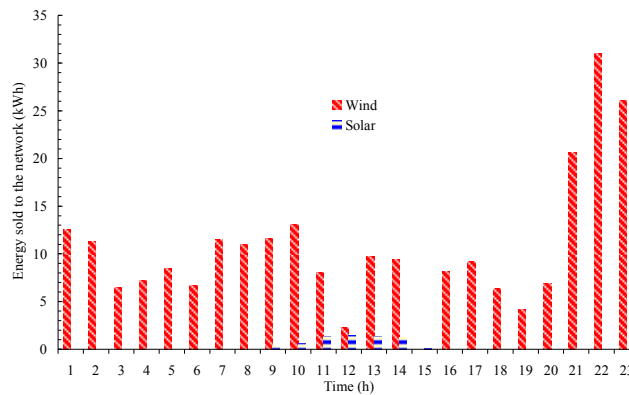

Figure 8: energy sold to the network

5. Conclusion

A DSS for real time energy management is here proposed to define the optimal energy flows in a building characterized by a mix of renewable resources (solar plate collector, PV, biomass, wind and battery storage) to satisfy different energy demands. The model is applied to the case of Capo Vado (Liguria Region) and optimal results to satisfy all the energy demands are found for a testing day in the month of November.

REFERENCES

- Ashok, S., Optimised model for community-based hybrid energy system, *Renewable Energy*, 32, 1155–1164, 2007.
- Deshmukh, M.K., and S.S. Deshmukh, Modeling of hybrid renewable energy systems, *Renewable and Sustainable Energy Reviews*, 12, 235–249, 2008.
- Ekren, O., and B.Y. Ekren, Size optimization of a PV/wind hybrid energy conversion system with battery storage using response surface methodology, *Applied Energy*, 85, 1086–1101, 2008.
- El Fadar A, Mimet A, Perez-Garcia M. Modelling and performance study of a continuous adsorption refrigeration system driven by parabolic trough solar collector. *Solar Energy*, 83, 50-861, 2009.
- Juan, Y.K., P. Gao., and J. Wang, A hybrid decision support system for sustainable office building renovation and energy performance improvement, *Energy and Buildings*, 42, 290–297, 2010.
- Hocaoglu F.O., Gerek O.N, Kurban M, A novel hybrid (wind–photovoltaic) system sizing procedure, *Solar Energy* 83 2019–2028, 2009.
- Nema, P., R.K. Nema, and S. Rangnekar, A current and future state of art development of hybrid energy system using wind and PV-solar: A review, *Renewable and Sustainable Energy Reviews*, 13, 2096–2103, 2010.
- Notton G., Muselli M., Poggi P., Louche A., Decentralized wind energy system providing small electrical loads in remote areas., *International Journal of Energy Research*, vol. 25, pp. 141-164, 2001.
- Rodolfo D.L., José L., Bernal A., Multi-objective design of PV-wind-diesel-hydrogen battery systems, *Renewable Energy*, vol. 33, pp. 2559-2572, 2008
- Paska, J., P. Biczal, and M. Kłos, Hybrid power systems – An effective way of utilising primary energy sources, *Renewable Energy*, 34, 2414–2421, 2009.
- Yang H., W. Zhou, L. Lu and Z. Fang , Optimal sizing method for stand-alone hybrid solar–wind system with LPSP technology by using genetic algorithm. *Sol Energy*, 82, 354–67, 2008.
- Xia, C., Y. Zhu, and B. Lin, Renewable energy utilization evaluation method in green buildings, *Renewable Energy*, 33, 883–886, 2008.