



HAL
open science

Traçability of refrigerant leak tightness

Isabelle Morgado, Pierre Otal, Jean-Claude Legras, Denis Clodic

► **To cite this version:**

Isabelle Morgado, Pierre Otal, Jean-Claude Legras, Denis Clodic. Traçability of refrigerant leak tightness. XIX IMEKO World Congress Fundamental and Applied Metrology, Sep 2009, Lisbon, Portugal. pp.1407-1412. hal-00576012

HAL Id: hal-00576012

<https://minesparis-psl.hal.science/hal-00576012>

Submitted on 11 Mar 2011

HAL is a multi-disciplinary open access archive for the deposit and dissemination of scientific research documents, whether they are published or not. The documents may come from teaching and research institutions in France or abroad, or from public or private research centers.

L'archive ouverte pluridisciplinaire **HAL**, est destinée au dépôt et à la diffusion de documents scientifiques de niveau recherche, publiés ou non, émanant des établissements d'enseignement et de recherche français ou étrangers, des laboratoires publics ou privés.

TRACABILITY OF REFRIGERANT LEAK TIGHTNESS

*Isabelle Morgado*¹, *Pierre Otal*², *Jean-Claude Legras*³, *Denis Clodic*⁴

¹Laboratoire National de Métrologie et d'Essais, Paris, France, isabelle.morgado@lne.fr

²Laboratoire National de Métrologie et d'Essais, Paris, France, pierre.otal@lne.fr

³Laboratoire National de Métrologie et d'Essais, Paris, France, j.c.legras@orange.fr

⁴Centre d'énergétique et des Procédés, École des Mines de Paris, Paris, France, denis.clodic@ensmp.fr

Abstract — Nowadays leak detection is widely used in various fields such as the automotive and the refrigeration industries. In France, the leak tightness of installations charged with refrigerants must be controlled periodically by refrigerant detectors, whose sensitivity thresholds are qualified according to several tests described in the European standard EN 14624. The tests described in the European standard are mainly a comparison between the detector signals and several appropriate calibrated leaks. In order to ensure the traceability of the calibrated leak flow rates, a project involving the Laboratoire National de Métrologie et d'Essais (LNE), the Centre d'Énergétique et des Procédés (CEP) and the Agence de l'Environnement et de la Maîtrise de l'Énergie (ADEME) was carried out to develop a national standard for calibrating R-134a leaks which are used in the tests. Besides, to ensure the fidelity of the sensitivity threshold measurements, a study has been carried out to identify the potential influence parameters. This document presents the national standard and the conclusions of this study.

Keywords : refrigerant gas, leak detector, leak flow rate

1. INTRODUCTION

Due to the Kyoto Protocol, the European countries must reduce their greenhouse gases emission like the fluorinated refrigerant gases (HFC). The European regulation n°842/2006 defines the leak tightness as the key point to reduce the emissions of the refrigerant gases. Therefore, the leak tightness of installations charged with more than 3 kg of refrigerants must be controlled periodically. In France, the installations with more than 2 kg of refrigerants (decree n°737/2007) must be controlled yearly by refrigerant detectors or room controllers, respectively with a detection limit of 5 g.yr⁻¹ and 10 μmol.mol⁻¹ (Order published in January 2000) [1], [2], [3].

Moreover, the implementation of regulation of leak tightness inspections required the elaboration of standards for the performances of refrigerant leak detectors and room controllers. A European standard EN 14624 published in July 2005 "Performances of mobile leak detectors and of room controllers of halogenated refrigerants » [4] describes

a testing method to qualify these detectors, which requires refrigerant calibrated leaks [1], [2].

However, the standard does not explicit the leak calibration method and the test conditions needed to ensure the reproductibility of the sensitivity threshold measurements. The main goal of this paper is to report to the industry the means that have been developed to respect the regulations relative to the leak tightness of refrigerating equipment. First the primary standard that ensures the traceability to the SI units of the R-134a calibrated leaks used to qualify leak detectors will be presented. Then using these reference calibrated leaks, the paper will report the identified parameters that may influence the sensitivity threshold measurements in order to ensure the fidelity of the qualification tests described in the standard.

2. PRIMARY STANDARD

2.1. Operating principle

The standard is based on the ability of the photo-acoustic spectrometer [5], [6] to distinguish the concentration of the gas species absorbing IR light in mixture with gases non-absorbing IR light. The calibration procedure consists in measuring the accumulation of the gas emitted by the refrigerant leak at atmospheric pressure in an enclosed volume. The rise of the refrigerant concentration is measured every minutes by an infrared photo-acoustic spectrometer - calibrated for the appropriate gas -, as most of refrigerant gases absorbs at wavelengths in the infrared range. Meanwhile, the temperature and the pressure inside the accumulation volume are measured along the time. Then the flow rate can be evaluated according the equation (1) using the weighted least squares method.

$$\dot{m} = \frac{M}{R} \cdot V \cdot \frac{\partial \left(\frac{PC}{T} \right)}{\partial t} \quad (1)$$

where M , R , V , C , P and T are respectively the molar mass of the gas, the perfect gas constant, the accumulation volume, the accumulated concentration, the pressure and the temperature inside the volume [1],[7].

2.2. Design of the primary standard

The primary standard is mainly composed of a main volume – the accumulation volume (see Fig. 1). The accumulation volume is composed by the accumulation cell, the internal volume of the spectrometer and their associated fittings. Besides, many instruments are used to measure temperature, pressure and concentration in time: platinum resistance thermometers, barometer, photo-acoustic spectrometer respectively [8], [9].

According to an initial comparison study between two available infrared spectrometers, the photo-acoustic spectrometer was selected to measure the concentration rise [2]. Its operating principle is based on the phenomenon called “photo-acoustic effect”: the absorption of the energy of a pulsed light by a sample of gas hermetically sealed in a cell is converted into sound pressure, which can be measured by microphones.

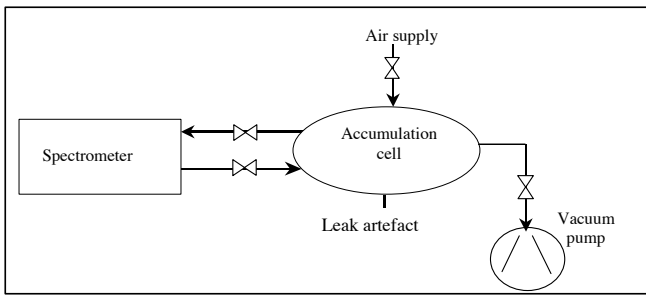

Fig. 1. Diagram of the primary standard

2.3. Qualification of the primary standard

The primary standard is mainly characterised by its accumulation volume and the performances of the photo-acoustic spectrometer.

By taking into account the restraints, and after evaluating the different methods available to measure a volume, it was decided to measure the accumulation volume by a static expansion method [9]. This method consists in generating a gas expansion between two volumes: the accumulation volume and a standard volume, whose capacity is calibrated with a relative uncertainty about 0.1% using a LNE tri-dimensional machine and [8]. By measuring the initial and final pressure and temperature in both volumes, the gas density changes inside the two volumes can be calculated [8], [10]. Applying the conservation of mass and the ideal gas law, the ratio of the volumes can be calculated according to the Equation (2):

$$\frac{V}{V_s} = \frac{\left(\frac{P_e}{T_e} - \frac{P_{res}}{T_{res}} \right)}{\left(\frac{P_0}{T_0} - \frac{P_e}{T_e} \right)} \quad (2)$$

where V and V_s are respectively the accumulation volume and the standard volume capacities, P_{res} , T_{res} are the initial pressure and temperature relative to the standard volume, P_0 , T_0 are respectively the initial pressure and temperature relative to the accumulation volume - before the expansion - and P_e , T_e are the pressure and temperature relative to the

equilibrium system {accumulation volume + standard volume} after the expansion.

Thus, the accumulation volume can be deduced from the ratio and the capacity of the standard volume. The accumulation volume uncertainty is calculated from the contributions of uncertainties originating from the homogeneity of the temperature inside both volumes, the pressure and temperature measurements, the calibration of the standard volume and the value of the ratios P/T fitted at the time of the valve opening. The size of the accumulation volume is calculated as: $V = (2.169 \pm 0.016) \text{ dm}^3$. The uncertainty is mainly due to the homogeneity of the temperatures and the repeatability of the method (see Fig. 2.).

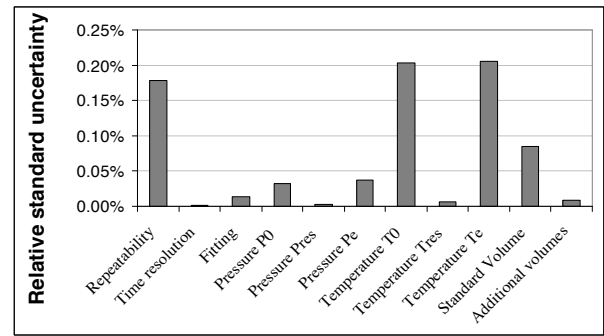

Fig. 2. Components of the uncertainty of the accumulation volume using the static expansion system: example of one calibration

The photo-acoustic spectrometer calibration is the second of the main components to measure a refrigerant calibrated leak. The instrument is calibrated by comparing the indications of the spectrometer with the concentration of standard mixtures, which are prepared using the gravimetric method: a well-known quantity of each gas is successively inserted into an evacuated gas cylinder.

The calibration procedure is the following: the mixtures – concentrations between 10 and 150 $\mu\text{mol}\cdot\text{mol}^{-1}$ - are successively circulating in the accumulation volume, while the concentration inside the accumulation volume is measured by the spectrometer. Concentrations below 10 $\mu\text{mol}\cdot\text{mol}^{-1}$ are not measured as the repeatability of the concentration measurement is about 0,5 $\mu\text{mol}\cdot\text{mol}^{-1}$.

The concentration uncertainty is calculated from the contributions of uncertainties originating from the [9] :

- repeatability of the calibration method,
- standard mixtures,
- temperature influence on the spectrometer
- uncertainty of the fitting $C_s = f(C_{read})$,
- resolution of the spectrometer, whose indication is limited to three digits, and
- spectrometer long term stability (see. Fig. 3.).

The combined uncertainty of the concentration measurement by the spectrometer is estimated as:

$$U = (1.5 + 1.7 \times 10^{-2} \times C) \mu\text{mol}\cdot\text{mol}^{-1}.$$

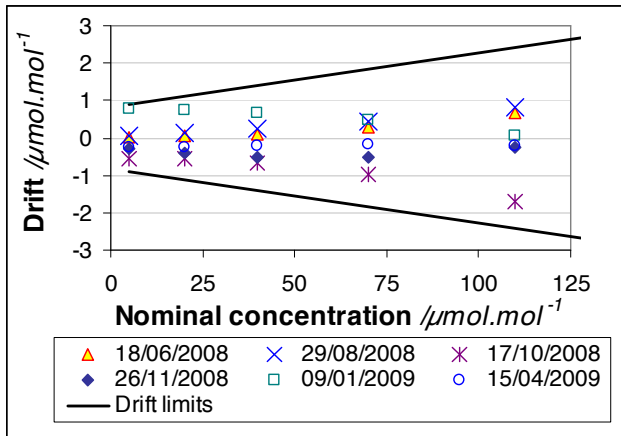

Fig. 3. Drift of the photo-acoustic spectrometer's fitted concentrations from the 18/06/2008 to 09/01/2009

Considering the qualification of the accumulation volume and the spectrometer, the uncertainty of the R-134a leak flow rate between 1 and 50 g/yr can be estimated. It includes the repeatability, the measurement of the variation in time of the concentrations corrected in pressure and temperature, the accumulation volume measurements. The repeatability of the method has been estimated about 0.20 % (see Fig. 4) and the expanded combined uncertainty is about 2 %.

In order to qualify refrigerant leak detectors, R-134a reference leaks, whose values are about 1 g/yr, 3 g/yr, 8 g/yr and 50 g/yr, have been purchased and are regularly calibrated by the primary standard. The temperature coefficients of the reference leaks have been checked. Considering the stability of a calibrated leak (see Fig. 5) and the influence of the temperature in a laboratory at $(20 \pm 1)^\circ\text{C}$, the expanded uncertainty of the flow rate is about 7 % for a reference leak used by the LNE to qualify refrigerant leak detectors.

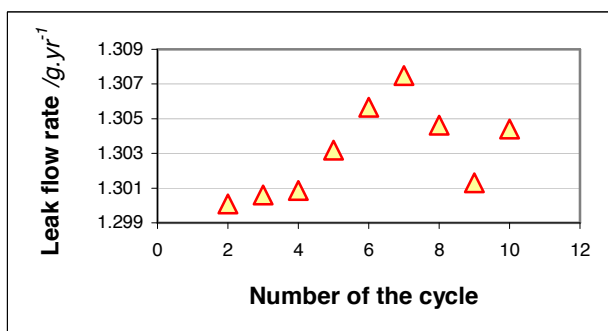

Fig. 4. Repeatability of a 1 g.yr⁻¹ leak calibration

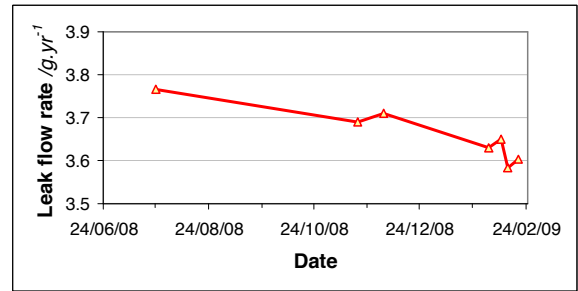

Fig. 5. Calibration of a calibrated leak flow rate about 3.6 g.yr⁻¹ between 24/07/08 and 19/02/2009, at 20 °C

3. DETECTOR SENSITIVITY THRESHOLD QUALIFICATION

3.1. Description of the detector qualification tests

As the refrigerant calibrated leaks can be traceable to SI units thanks to the new primary standard, the standard EN 14624 or other standards to qualify the refrigerant hand leak detectors can now be applied.

Four tests are described in the standard to qualify the performances of a locating refrigerant leak detector in order to assess its sensitivity threshold. The lowest detected flow rate of the available calibrated leak is considered as the sensitivity threshold.

This sensitivity is measured when the detector is stationary at a specified distance from the leak, when it is moving at a specified translation speed and at a specified distance from the leak, in a clean or polluted ambience.

3.2. Identification of the influence parameters

In order to qualify leak detectors in the best conditions, complementary technical requirements are necessary to identify precautions that must be taken during the performance tests. Whatever detection method is considered, a detector measures a concentration and not directly a leak flow rate [11]. Hence many parameters can influence the relation between concentration and leak flow rate, as the volume is not closed and not well-defined. It depends on several parameters. Experimental and phenomenological studies have been carried out in order to identify some of them.

Contrary to the primary standard conditions, the reference leak flows in an open volume that will be named "control volume". Therefore, the equation (1) cannot be applied. A first approximation of the relation between concentration and leak flow rate can be done by considering that the refrigerant gas quantity sucked by the detector in one second is equal to the quantity sent out by the leak artefact in the same time. In this case, the equation can be expressed as:

$$C = \frac{Q}{\rho \cdot Q_v}, \quad (3)$$

where Q , C , ρ , Q_v are respectively the refrigerant leak flow rate, the concentration of the refrigerant in the control

volume, the refrigerant gas density and the volume sucking rate of the detector. This approximation means that the concentration depends on the sucking rate of the detector [12]. However, assumptions have been made to simplify the equations: the air speed around the control volume and the gravity are for instance considered as negligible. Besides, the distance between the detector nose and the outlet of the leak are not considered. In order to establish the concentration gradient in the control volume, a phenomenological study with the CFD software FLUENT and experiments were carried out.

With the CFD software FLUENT, a simulation of the gas concentration tendency in a control volume has been established [9]: the studied control volume was an opened cylinder. Its length was defined as the distance between the leak and the detector nose and the diameter of the control volume was set equal to 10 mm. The study has been reduced to this control volume in order to have a highly refined grid mesh (see Fig. 6).

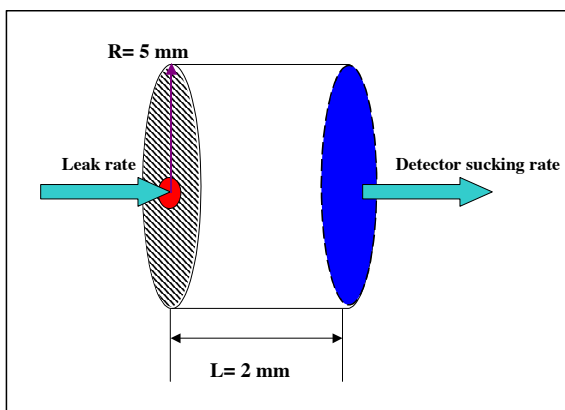

Fig. 6. Description of the control volume used for the CFD simulation

The experimental study [9] aimed at drawing a cartography of the concentration near a R-134a calibrated leak in order to validate the tendency shown on the phenomenological CFD study. The concentration changes have been checked near the leak artifact orifice: the detector nose was placed at different distances from the leak and different altitudes from the orifice of the leak artifact (see Fig. 7). A detector, which indicates leak flow rate values and whose sensitivity threshold is about 1 g/yr, has been used for this experiment. Complementary to the detector, the photo-acoustic spectrometer was also used.

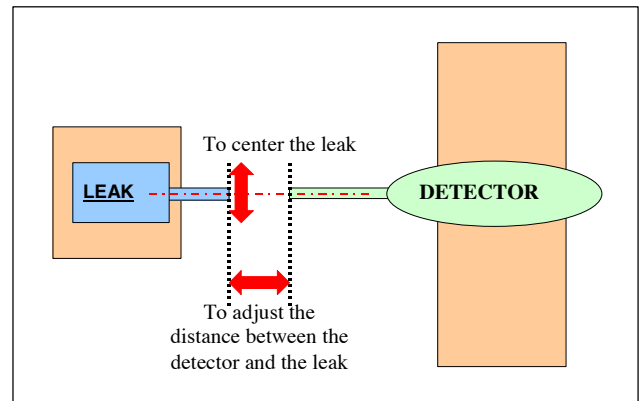

Fig. 7. Diagram of the experimental installation

As expected, the concentration decreased significantly with the distance of the detector probe from the leak. Experiments have shown that the detector capability to detect a $1 \text{ g}\cdot\text{yr}^{-1}$ leak decreases with the distance. The indication of the detector was divided by 2 when the distance was increasing from 1 mm to 2 mm. For a distance higher than 3 mm, the leak flow rate was not detected anymore. Besides, the influence of the gravity was also checked. Indeed, R-134a is heavier than air: its density at 101 kPa and at 20°C is $4.36 \text{ kg}\cdot\text{m}^{-3}$. In theory, R-134a tends to « fall » due to the gravity. The simulation by FLUENT underlined this phenomenon (see Fig. 8): the concentration of R-134a decreased when the altitude was increasing. This trend was all the more amplified when the detector sucking rate was lower. In the case of a high sucking rate, the gravity influence was then compensated. However, the concentration remained higher in front of the leak. Experiments were in agreement with these results.

As the sensitivity threshold of a detector is also checked when it is moving, a comparison between the 1 g/yr detector indications and the 1 g/yr leak flow rate was done when the detector was moving at different speeds. This experiment has underlined the influence of the translational speed of the detector: the detection improves when the speed decreases. Indeed, if the distance traveled in one second by the detector is higher, the control volume that must be considered has to be also larger.

To conclude, several parameters may influence the expression of the conversion of the concentration to a leak flow rate: the distance from the leak, the direction of the detector nose relatively to the leak axis, the gravity. These parameters must be controlled in order to ensure the repeatability of the sensitivity threshold measurements.

Therefore, some precautions must be taken into account during the qualification tests described in the standard. The design of the test bench has been done considering these parameters.

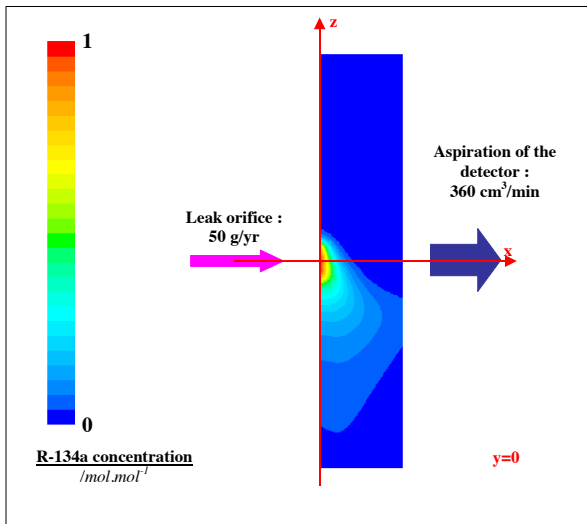

Fig. 8. Dispersion of the R-134a simulated by the CFD software FLUENT

3.3. Precautions in the qualification procedure

The identified influence parameters have to be controlled for ensuring the repeatability of the tests. Only the detector sucking flow rate depends on the manufacturer and cannot be controlled. A test bench to qualify the detector according to the standards has been designed and realized in order to control the other influence parameters. It is a mobile platform, moving from left to right and vice-versa in front of a standard leak orifice whose nominal value is between 1 g.yr^{-1} and 50 g.yr^{-1} . As the position of the detector nose according to the leak orifice, the gravity and the translational speed of the detector nose may influence the results (see Fig. 9), these parameters must be controlled. The test bench has been realised considering these specifications (see Fig. 10.).

Distance between the detector and the leak <i>mm</i>	Detector average translation speed	
	2 mm.s^{-1}	50 mm.s^{-1}
	Maximum mass flow rate indicated by the detector <i>g.yr⁻¹</i>	
1	2.3	0.6
2	0.7	0.2
3	0.4	0.3
5	0.2	No detection

Fig. 9. Maximum value indicated by the detector when it moves in front of a calibrated leak whose flow rate is $(1.33 \pm 0.053) \text{ g.yr}^{-1}$.



Fig. 10. Photo of the LNE test bench to qualify the refrigerant leak detectors according to the standard NF EN 14624

4. CONCLUSION

To conclude, the traceability of refrigerant detector qualification is now ensured. The LNE can provide calibration of R-134a leaks between 1 g/yr to 50 g/yr , in their operating conditions with a relative expanded uncertainty around 1-2%, at a fixed leak temperature. It is a necessary support to ensure the traceability of the calibrated leaks needed to qualify the refrigerant detectors, as the leak operating conditions are respected. Even if only R-134a leaks can be measured now, an extension to other gases will be studied.

Complementary to the leak primary standard, a test bench has been realized in order to qualify R-134a detectors according to the standard EN 14624. As a hand leak detector measures a concentration and not a leak flow rate, some parameters that have been identified can influence the qualification results: position of the detector probe, absence of obstacles below the calibrated leak, air disturbances. The test bench has been designed considering the precautions that must be taken.

REFERENCES

- [1] D. Clodic, N. Torbey, F. Fayolle, "Qualification of leak detectors – Calibration of leak artefacts" (Qualification des détecteurs de fuite – Étalonnage des fuites calibrées), *Colloque à effet de Serre III*, 2002.
- [2] D. Clodic, "Measurement and Control of Refrigerant Leaks", *AICARR Conference*, 2000.
- [3] D. Clodic, *Zero Leaks*, ASHRAE, ch.6, pp89-94, 1998.
- [4] "Performance of portable halogenated refrigerant leak detectors and room controllers", *AFNOR*, European standard, NF EN 14624, July 2005.
- [5] S. Schäfer, A. Miklós, P. Hess, "Photo-acoustic Spectroscopy, Theory", *Encyclopedia of Spectroscopy & Spectrometry*, Lindon J, Tranter G, Holmes J, Eds, 1999, pp. 1815-1822.
- [6] Rosencwaig, *Photo-acoustics and photo-acoustic spectroscopy*, John Wiley and Sons, 1980.
- [7] N. Torbey, D. Clodic, "Calibration method of a primary standard for measuring calibrated leaks artefact, in order to

verify refrigerant leak detectors” (Méthode d'étalonnage sur un étalon primaire des fuites calibrées permettant la vérification des performances des détecteurs de fuites des fluides frigorigènes) , ADEME (01 74 084/11243), 75pp., December 2002.

- [8] I. Morgado, J.C. Legras, D. Clodic, “Primary standard for measuring refrigerant leak flow rate” (Étalon primaire pour les débits de fuites frigorigènes), *Actes de conférences au Congrès de métrologie*, 2007, Lille, France.
- [9] I. Morgado, Design and realization of a primary and secondary leak standards for the measurement of leak flow rates of refrigerants, Thesis, Centre d’Energétique et des Procédés, Ecole des Mines de Paris, 14 November 2008, 166p.
- [10] J.D. Wright, A.N. Johnson, M.R. Moldover, “Design and Uncertainty Analysis for a PVTt Gas Flow Standard”, *Journal of Research of the National Institute of Standards and Technology*, vol. 108, n°1, Jan/Feb 2003, 21-47.
- [11] A. Malek, “Leak detectors : operating principle and commercial offer” (Détecteurs de fuites: Principe et offre commerciale), *Revue Générale du Froid*, 33-41, June 1995.
- [12] I. Morgado, J-C. Legras, D. Clodic, “Détecteur de fuite suivant la norme EN 14624 : chaîne d’étalonnage et vérification” , *Colloque à effet de Serre VII*, October 2008.