



**HAL**  
open science

# Dynamic Modelling of Large Autonomous power systems with high penetration from renewable (wind & hydro) power sources

Georges Kariniotakis

► **To cite this version:**

Georges Kariniotakis. Dynamic Modelling of Large Autonomous power systems with high penetration from renewable (wind & hydro) power sources. EWEC 1999, Mar 1999, Nice, France. pp.421-424. hal-00544845

**HAL Id: hal-00544845**

**<https://minesparis-psl.hal.science/hal-00544845>**

Submitted on 5 Feb 2018

**HAL** is a multi-disciplinary open access archive for the deposit and dissemination of scientific research documents, whether they are published or not. The documents may come from teaching and research institutions in France or abroad, or from public or private research centers.

L'archive ouverte pluridisciplinaire **HAL**, est destinée au dépôt et à la diffusion de documents scientifiques de niveau recherche, publiés ou non, émanant des établissements d'enseignement et de recherche français ou étrangers, des laboratoires publics ou privés.

# DYNAMIC MODELLING OF LARGE AUTONOMOUS POWER SYSTEMS WITH HIGH PENETRATION FROM RENEWABLE (WIND & HYDRO) POWER SOURCES.

G. N. Kariniotakis,  
Ecole des Mines de Paris,  
Centre d'Energétique,  
B.P. 207, Sophia Antipolis, France.

**ABSTRACT:** This paper presents a model for the transient stability analysis of isolated power systems including various conventional (thermal, gas, diesel) and renewable (hydro, wind) power units. The objective is to assess the impact of a high integration from renewables and to focus on the interaction between hydro units - which have a special dynamic behaviour, and wind turbines. Detailed models for the power system components are developed. Emphasis is given to the representation of different hydro power plant structures. An algorithm is proposed for the identification of the unknown power system parameters. The examined case study is the one of the power system of New Caledonia, where various types of hydro plants and a wind farm are installed. The developed model permits to define penetration limits for the renewable sources, to define rules for the safe operation of the system and finally it contributes to the dimensioning of new power plant installations.

**KEYWORDS :** Dynamic modelling, multimachine power system, wind turbines, hydro turbines;

## 1. INTRODUCTION

In recent years there has been a growing interest for electricity generation in autonomous systems using renewable power sources due to the high cost of conventional generation. The aim of the paper is to assess the impact on the quality of service (disturbances on frequency and voltage) that renewable sources may have due to their stochastic nature.

The paper presents an advanced multi-machine model for the simulation of the transient behaviour of an autonomous power system. The time scale of the examined phenomena is between 0-30 seconds or more. Various disturbances can be handled like elements switching, symmetrical short-circuits, operation under turbulent wind, islanding etc. Power systems with steam units, gas turbines, diesel engines, hydro plants and wind parks can be simulated. Detailed models are considered for each one of the above types of units as well as for the grid elements and the load.

Emphasis is given on developing detailed models for the hydroelectric plants. The transient behaviour of these plants depends on structural elements like the tunnel, the surge tank, the conduits, etc. In large systems, where a number of hydro turbines are supplied by a common tunnel, oscillations may appear through the conduits of the turbines. Moreover, the particularity of the dynamic behaviour due to the water hammer effect and the long term oscillations, when a surge tank is present, make it interest to study the interaction between hydro plants and wind parks.

Often, a major problem in transient analysis studies concerns the availability of the power system parameters. The paper presents a methodology to estimate these parameters from measurements. The non-linear simplex optimisation technique is used for this purpose. Emphasis is given to the appropriate definition of the objective function, as well as to the definition of constraints on the parameter values to guarantee their physical meaning.

The case study of the French Island of New Caledonia in the Pacific is examined. This system contains steam,

diesel and gas units, a wind farm of 2.7 MW and various types of hydro plants. 30% of the demand is covered by renewable sources (hydraulic and wind). A particularity of this system is the high industrial demand (70% of the total demand) due to the nickel mining industry. The various load components have an important impact on the dynamic behaviour of the system.

## 2. DESCRIPTION OF THE MODEL

In [1] a model is presented for the simulation of wind-diesel power systems. Models for the mechanical part of a wind turbine, an asynchronous generator, diesel engine, synchronous generator and capacitor banks are presented. A new multimachine power system formulation is developed that permits the representation of the power system in a generic and modular way.

Here, for the simulation of large systems, models for the steam units (with single or double reheat) and their speed governing systems [3] have been considered.

### 2.1. Hydro Turbines Modelling

Two types of hydro plants are of interest here :

- of a turbine fed trough a tunnel with or without a surge tank.
- of  $n$  turbines fed by a common tunnel with or without a surge tank.

The modelling of the mechanical part depends on the configuration of the plant. Independently of the type of installation, a synchronous generator [1], a voltage regulator [1] as well as appropriate speed regulator models [3] are associated to each turbine.

Initially, the simplest case of a turbine fed by a simple penstock of length  $L$  and cross-section  $A$  and without surge tank is considered. By assuming incompressible fluid, the rate of change of flow  $q$  in the conduit is given from the laws of momentum in the per unit (p.u.) system as :

$$\frac{dq}{dt} = \frac{1}{T_w} (1 - h - h_t)$$

where  $h$  is the head at the turbine,  $h_t$  represents penstock head losses and  $T_w$  is the water time constant defined as :

$$T_w = \frac{L}{Ag} \frac{Q_{base}}{H_{base}} \quad \text{secs}$$

where  $Q_{base}$  and  $H_{base}$  are the base flow and head and  $g$  is the acceleration of gravity ( $9.81 \text{ m/s}^2$ ). The p.u. flow rate through the turbine is given by :  $q = G\sqrt{h}$  where  $G$  is the per unit gate position. The p.u. mechanical power developed at the turbine is :

$$P_m = A_t h(q - q_{nl}) - DG\Delta\omega$$

where  $q_{nl}$  is the per unit no-load flow and  $A_t$  is a proportionality constant.

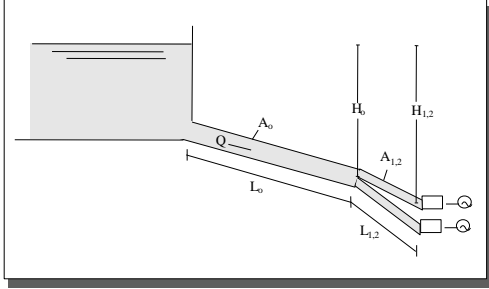

**Figure 1 :** Schematic representation of a plant of two hydro turbines fed by a common tunnel.

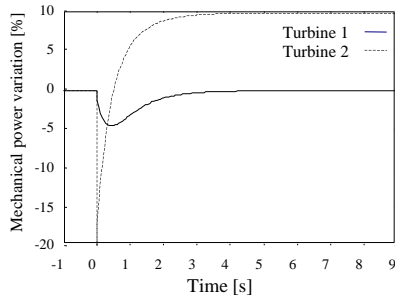

**Figure 2 :** Mechanical power variation at each hydro turbine following a 0.1 p.u. gate opening at the 2<sup>nd</sup> turbine.

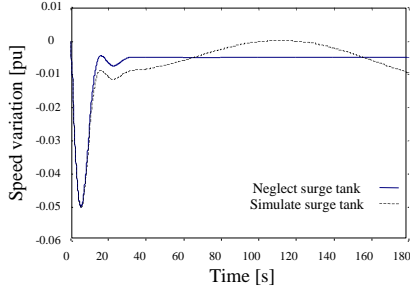

**Figure 3 :** Speed variation of a hydro turbine following a 0.1 p.u. load increase.

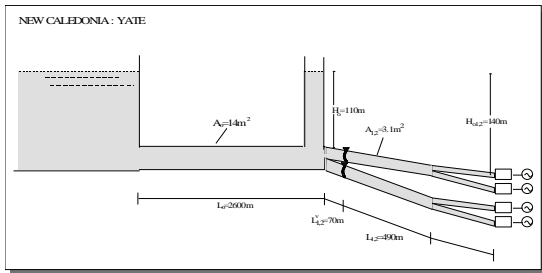

**Figure 4 :** Schematic representation of the Yaté plant at the island of New Caledonia ( 4 turbines of 17 MW each ).

In certain installations a number of hydro turbines are fed by a common tunnel. In these cases there is a hydraulic

coupling between the turbines. The differential equations describing the change in the flow rate at each conduit are given in a matrix form :

$$\begin{bmatrix} \dot{\Phi}_1 \\ \dot{\Phi}_2 \end{bmatrix} = \begin{bmatrix} T_w + T_{w1} & T_w \\ T_w & T_w + T_{w2} \end{bmatrix}^{-1} \begin{bmatrix} 1 - h_1 \\ 1 - h_2 \end{bmatrix}$$

where  $T_w$  is the water time constant of the tunnel and  $T_{w1}$ ,  $T_{w2}$  are the water time constants of the two conduits defined in a similar way as for the simple case.

Figure 2 shows the dynamic response of two turbines fed by a common tunnel following a 0.1 p.u. gate opening at the second turbine. Due to this change, a variation of 5% is observed at the mechanical power of the first turbine. The figure shows also the particularity in the dynamic behaviour of the hydro units related to the water hammer effect. The gate opening action corresponds to a load increase at the turbine. However, before load increases there is a first dip as shown in Figure 2. A similar case when the hydro turbines can "see" a load increase as the one simulated here can be during a sharp decrease of the wind power contribution to the load (e.g. wind park disconnection). Then, the power dip of the hydro production can be superposed to the lack of wind generation and have a transient attenuation of the power imbalance. Here, the effect of the speed regulators was neglected in order to simulate the most pessimist case. In reality the magnitude of this dip is partly damped by the regulators' action.

In certain situations when the hydraulic station is in distance from the dam, a surge tank is built near the turbines to damp dynamic phenomena due to flow variations. Figure 3 shows the dynamic response of a system of a single turbine with a surge tank following a 0.1 p.u. load increase. Two models that take into account or neglect the effect of the surge tank are compared. The action of the speed regulator is taken into account. The surge tank does not affect significantly transient behaviour in very short-term. It provokes however oscillations of several quantities that have a period in the order of a minute. Continuous wind power variations may act as disturbances that excite these long-term dynamics.

Figure 4 shows the structure of the largest hydro plant at the island of New Caledonia (multiple units, surge tank).

### 3. IDENTIFICATION OF UNKNOWN PARAMETERS

A major problem in the simulation of the dynamic behaviour of a power system is to have accurate values for the various element parameters. Often parameter values are known by the manufacturer but in many cases they do not correspond to effective values due to ageing problems, modifications due to maintenance etc.

Here, a procedure is proposed for the identification of unknown parameters from measurements. The optimisation algorithm is the non-linear simplex method under constraints [2]. The general identification scheme is shown in Figure 5 in which :

$[P]$  is the vector of the unknown power system parameters.

$[Y_{AC}(t)] = [y_{AC}^1, y_{AC}^2, \dots, y_{AC}^m]^T$  is the output of the physical system obtained by the test.  $y_{AC}^i$  is the measured value of the power system frequency or bus bar voltage at time instant  $i$ ,  $i=1,2,\dots,m$ .

$[Y_{ID}(t, P)] = [y_{ID}^1, y_{ID}^2, \dots, y_{ID}^m]^T$  is the output of the simulation model.  $y_{ID}^i$  is the estimated by the model frequency or voltage value at time instant  $i, i=1, 2, \dots, m$ .  $[U(t)]$  is the disturbance vector (e.g. load change), which is the input both to the physical system and to the model.

The output of the physical system  $[Y_{AC}(t)]$ , which is obtained by the test, is compared to the output of the simulation model  $[Y_{ID}(t, P)]$ .

Below is given the formulation of the optimisation problem for the case that the parameters of a diesel unit are identified. The following parameters are considered as unknown ( $P = [H, T_D, R, K_I, D]$ ):

$$\min J(P) = \sum_{i=1}^m w_i (f_{AC}^i - f_{ID}^i)^2$$

under constraints :

1.  $H^{\min} < H < H^{\max}$
2.  $T_D^{\min} < T_D < T_D^{\max}$
3.  $R^{\min} < R < R^{\max}$
4.  $K_I^{\min} < K_I < K_I^{\max}$
5.  $D^{\min} < D < D^{\max}$

where :

$f_{AC}^i$  is the frequency measurement at time instant  $i$  and

$f_{ID}^i$  is the frequency as obtained by the simulation model.

$H$ : inertia time constant (sec),

$T_D$ : diesel engine prime mover and governor time constant (sec)

$R$ : regulation parameter (p.u. Hz / p.u. kW)

$K_I$ : secondary (integral) control (p.u. kW / p.u. Hz)

$D$ : load damping coefficient (p.u. kW / p.u. Hz)

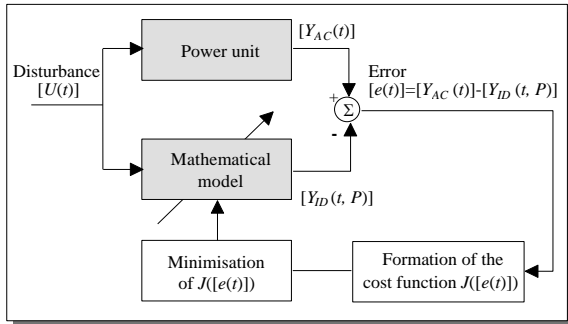

Figure 5 : Identification scheme.

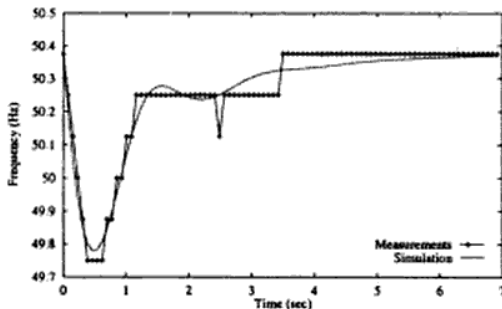

Fig. 6: Identification of diesel-engine/governor parameters.

Of primary importance in the optimisation process is the way the objective function is defined. In the above formulation, this function is the weighted sum of the

squared error mismatches between measured and simulated power system frequency. The inclusion of weights is determinant for the success of the identification process. Figure 6 shows a series of frequency measurements performed for a period of 7 seconds. The measured curve can be divided in 3 sectors : between 0-1.1 sec, where the first dip takes place (16 measurements), between 1.1-3.6 sec of the first flat part (30 measur.) and between 3.6-7 sec (45 measur.). If weights are not considered, as is often seen in the literature, the optimisation process risks to converge to a set of parameters that does not properly represent the dynamics of the first dip. The measurements included in the first dip need to be overweighted in the error function.

#### 4. CASE-STUDY

The case study examined here is the island of New Caledonia located 1500 km east to Australia. Its surface is 18.760 km<sup>2</sup> for a length of 400 km and a width of 40-50 km. The population is 145.000 inhabitants (90.000 for the capital city Nouméa). The island disposes more than 25% on the world's known nickel resources - 3<sup>rd</sup> producer in the world. The nickel mining industry is the principal base of the economy of the island.

The installed power is 273 MW. The annual production is 1.400 GWh (1994, +9%). The electric demand in the island is between 110-210 MW. 70 % of this demand comes from the industrial sector (peak 126 MW). The peak of the public sector is 79.5 MW (1997). 75% of public demand comes from the capital Nouméa in the southern part of the island. Figure 7 represents a typical day of the power system demand and generation.

Industrial demand is located at a nickel-melting factory and is composed principally by three melting furnaces of 40 MW each. This demand is in general constant in a weekly basis. Important variations are determinant for the form of the daily load curve (see Figure 7). The base load is supplied by diesel units and alternatively by steam or hydro units depending on the season.

The structure of the grid (2 closed loops) is shown in Figure 7. It consists mainly of 150 kV and 33 kV lines. A reactance of 5 MVAR is installed at the level of Népoui plant for the absorption of the excess reactive power generated by the high voltage (150 kV) transmission lines.

In very short-term, transient variations of the industrial load have an important impact on the system frequency. For example, variations of a few MWs may appear in a few seconds. The three furnaces dispose protections for their disconnection which are activated when the system frequency passes the threshold of 48.6 Hz. During the study the following major event was observed. A steam unit (37 MW) was disconnected for some unknown reason. This disconnection provoked a decrease in frequency that activated the protections of the furnaces. The ensemble of the three furnaces (75 MW) was disconnected simultaneously resulting to a frequency deviation to 51.1 Hz. At the same time the underfrequency protection relays of the wind park were activated resulting to the disconnection of the park from the network. Despite the major superposed disturbances observed the system did not collapse.

In order to represent accurately the operating conditions at the grid measurements from the installed

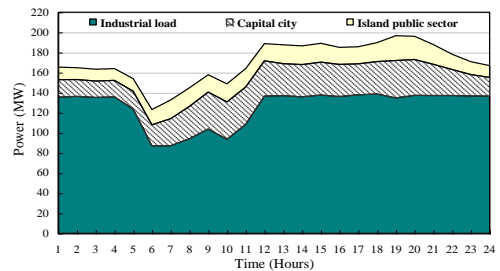
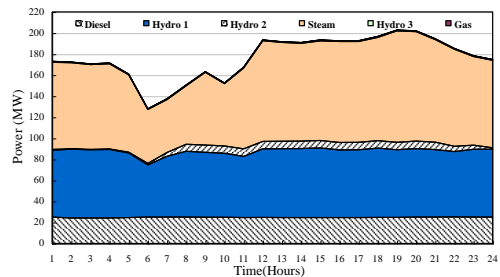
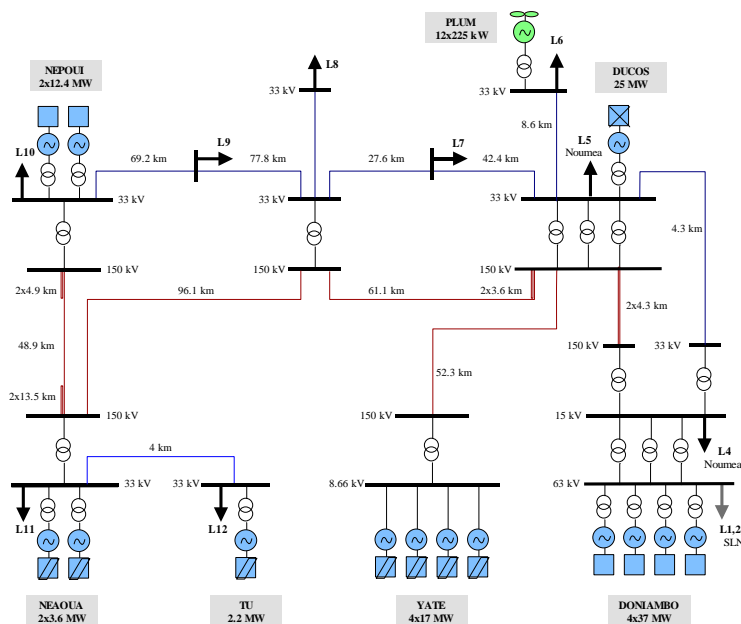

Figure 7 : (LEFT) One-line diagram of the system of NewCaledonia. (RIGHT) Generation and demand during a typical day.

PLANT TYPE	SITE	UNITS	TOTAL (MW)
STEAM PLANT	Doniambo	4x37 MW	148
HYDRO PLANTS	Yaté	4x17 MW	77.4
	Néaoua	2x 3.6 MW	
	Tu	1x 2.2 MW	
DIESEL STATION	Népoui	2x12.4 MW	24.8
GAS TURBINE	Ducos	1x20 MW	20
WIND PARK	Plum	12x225 kW	2.7

deviation following the simultaneous disconnection of all the wind turbines (total 20 MW). This frequency variation is in acceptable levels. The figure shows also the voltage variations at various bus bars of the system.

## 5. CONCLUSIONS

This paper extends previous work on the modelling of isolated power systems [1]. Emphasis was given to the representation of hydro units. The particularity of the transient behaviour of these units was discussed in detail through simple examples. The case study of the system of New Caledonia was presented. This system presents great interest due to the various types of units, the high integration from renewables, and its load structure.

The dynamic model proves to be a useful tool for the design of new renewable installations, the definition of maximum penetration limits for wind power, as well as for establishing rules for the safe operation of the power system.

## REFERENCES

- [1] KARINIOTAKIS G. N, STAVRAKAKIS G. S., "A general simulation algorithm for the detailed assessment of isolated Diesel-wind turbines interaction", Parts I-II, *IEEE Transactions on Energy Conversion*, Vol. 10, No. 5, Sept. 1995, pp. 577-590.
- [2] KARINIOTAKIS G. N., *Contribution to the development of an advanced control system for wind-diesel power systems*, PhD thesis, Ecole des Mines de Paris, Centre d'Énergétique, December 1996.
- [3] IEEE Committee report, "Dynamic models for steam and hydro turbines in power system studies", *IEEE PES Winter Meeting, New York, Jan. 28-Feb. 2, 1973*.

## ACKNOWLEDGEMENT

The Utility of New Caledonia ENERCAL is greatly thanked for the precious collaboration and the data provided for the purpose of this study.

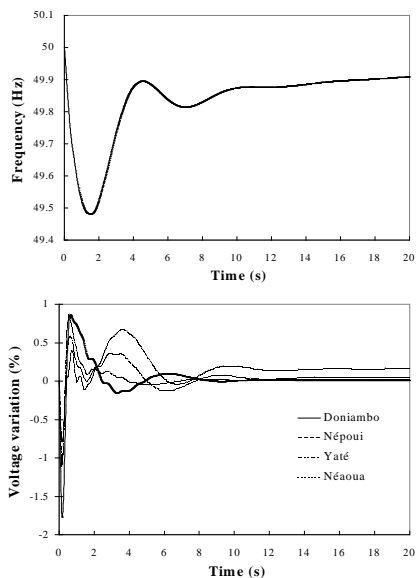

Figure 8 : Frequency and voltage variations following the disconnection of a wind farm of 20 MW.

SCADA system were considered for the power flows and the voltage at various points of the network. These data permitted to verify assumptions on the transformer settings, the transmission line parameters etc and perform accurate load flow analysis.

In order to analyse the behaviour of the system under higher wind penetration conditions (up to 20%) a wind farm of 20 MW is assumed. Figure 8 shows the frequency