



HAL
open science

Optimization of a range of 2D and 3D bulk forming processes by a meta-model assisted evolution strategy

Lionel Fourment, Thomas Massé, Stéphane Marie, Richard Ducloux, Mohsen Ejday, Christian Bobadilla, Pierre Montmitonnet

► **To cite this version:**

Lionel Fourment, Thomas Massé, Stéphane Marie, Richard Ducloux, Mohsen Ejday, et al.. Optimization of a range of 2D and 3D bulk forming processes by a meta-model assisted evolution strategy. 12th ESAFORM Conference on Material Forming, Apr 2009, Enschede, Netherlands. pp.Pages 343-346, 10.1007/s12289-009-0476-y . hal-00509409

HAL Id: hal-00509409

<https://minesparis-psl.hal.science/hal-00509409>

Submitted on 12 Aug 2010

HAL is a multi-disciplinary open access archive for the deposit and dissemination of scientific research documents, whether they are published or not. The documents may come from teaching and research institutions in France or abroad, or from public or private research centers.

L'archive ouverte pluridisciplinaire **HAL**, est destinée au dépôt et à la diffusion de documents scientifiques de niveau recherche, publiés ou non, émanant des établissements d'enseignement et de recherche français ou étrangers, des laboratoires publics ou privés.

OPTIMIZATION OF A RANGE OF 2D AND 3D BULK FORMING PROCESSES BY A META-MODEL ASSISTED EVOLUTION STRATEGY

L. Fourment^{1*}, T. Massé¹, S. Marie², R. Ducloux², M. Ejday¹, C. Bobadilla³, P. Montmitonnet¹

¹ Mines ParisTech, CEMEF - Centre for Material Forming, CNRS UMR 7635, BP 207, 1 rue Claude Daunesse, 06904 Sophia Antipolis Cedex, France

² Transvalor S. A., Parc de Haute Technologie, Sophia-Antipolis, 694, av. du Dr. Maurice Donat, 06255 Mougins Cedex, France

³ ArcelorMittal Gandrange, Research Center Long Carbon Bars & Wires, Site Industriel de Gandrange, 57300 Amnéville, France

ABSTRACT: After decades of developing efficient software, FORGE, for bulk metal forming simulation, its coupling with an optimization algorithm is considered in order to solve the actual engineering problem, the design problem, using the meta-model assisted evolution strategy proposed by Emmerich et al. The first application regards the shape optimization of a cylindrical preform to produce a crankshaft by closed die forging. It aims at minimizing the volume of the material while satisfying the filling of the dies. In the second application, the open die forging of an axisymmetric thick plate is considered. The objective is to optimize the initial geometry in order to minimize the material weight while overlapping a prescribed geometry at the end of forging. The third example regards a four-stepped wire drawing sequence. In order to prevent the formation of cracks, it is desired to minimize a damage criterion while keeping the targeted diameter of the final wire. The geometries of the four dies are optimized: reduction ratio, die angle and die length. The necessary calculations are run in parallel, by using both the parallel version of the software and by evaluating several designs at the same time.

KEYWORDS: Optimization, Forging FORGE software, META-ES

1. INTRODUCTION

During recent years, several optimization algorithms have been proposed for highly time consuming problems, as encountered in non-steady forming processes such as forging. Most of them are based on meta-modelling techniques, like response surfaces, moving least squares, meshless finite difference method or Kriging. In order to handle very general optimization problems, it was decided to select an efficient and robust algorithm, which requires that the meta-model continuously evolves during the optimization iterations. Consequently, the Meta-model Assisted Evolution Strategy (MAES) proposed by Emmerich et al. [1], which has shown its efficiency and robustness in several complex metal forming applications [2,3], was selected. This algorithm makes it easy to handle two levels of parallelization: the parallelization of the finite element software itself, which is here automatically managed by FORGE, and the parallelization of the optimization algorithm. As the exact number of function evaluations is a priori known for each algorithm iteration, they can easily be carried out in parallel. The combination of

these two parallelization strategies allows to significantly reduce the computational cost on a cluster of several processors, and so tackling rather large and complex metal forming problems. In order to evaluate the robustness of the proposed strategy, a large range of bulk forming processes have been considered. Three among the most representative are presented here.

2. MAES algorithm

Meta-model Assisted Evolution Strategies (MAES) are regarded as quite robust algorithms with respect to local extrema. They make it possible to solve the most complex optimisation problems. Evolutionary algorithms (ES) typically consist of three operators: selection, recombination and mutation. They are similar to Genetic Algorithms (GA), with slight differences. Mutation is the main genetic operator while recombination is not systematically used. In general, ES can find a solution more rapidly, whereas GA would find a more global extremum. However, the costs of both ES and GA are usually quite high in terms of function evaluations. MAES proposed by Emmerich et al [1] combines an ES with Kriging meta-models to reduce the number of

* Corresponding author: L. FOURMENT, CEMEF, BP 207, 1 rue Claude Daunesse, 06904 Sophia Antipolis Cedex, France, phone: +33 (0)4 9395 75 95, fax: +33 (0)4 92 38 97 52, lionel.fourment@mines-paristech.fr

function evaluations. An overview of MAES is depicted in Figure 1. It starts by randomly choosing an initial population of two times the number of optimization parameters. The number of parents, λ , is also set to 2 times the number of optimization parameters, while the number of children, μ , is set to 4 times λ .

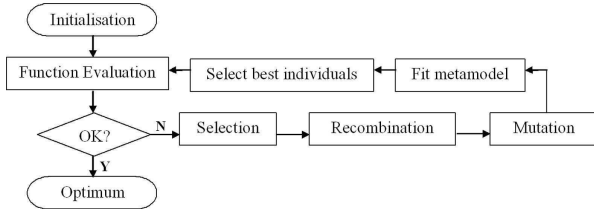

Figure 1: Overview of MAES (from [3])

After having run the F.E. simulations for the initial population, the λ best settings are selected, recombined and mutated to yield μ children. The results of the previously performed F.E. calculations are used to fit a Kriging meta-model, so instead of running the expensive F.E. calculations for the μ children, the results are first estimated. The objective function values f are not directly approximated by \tilde{f} , but by $\tilde{f} - \Delta\tilde{f}$, where $\Delta\tilde{f}$ is the Root Mean Square Error of the Kriging approximation. $\tilde{f} - \Delta\tilde{f}$ is the *merit function*; it represents an estimation of the lowest achievable value of f . Based on these predictions, only the best λ individuals are actually evaluated by running the F.E. simulations. In this way, the meta-modelling technique saves 80% of time-consuming F.E. calculations. The Kriging meta-model is then updated, and this procedure is repeated until the maximum number of F.E. simulations is reached; it is here set to 10λ (20 times the number of optimization parameters).

3. PARALLEL CALCULATIONS

According to the problem size, each F.E. calculation can be run on a certain number of processors, $N_{F.E.}$. It is useless to appeal to too many processors because the parallel efficiency decreases after a certain number. On the other hand, it is quite efficient to benefit from the parallel structure of the ES, by running the λ F.E. simulations at the same time on different machines. Consequently, $\lambda N_{F.E.}$ processors can be used for the parallel calculations, with a very high efficiency.

4. FORGING OF A CRANKSHAFT

The first application regards the shape optimization of a cylindrical preform (see Figure 2) that is used to produce a crankshaft by closed die forging (see Figure 3). Two types of parameterizations are considered. The first one is a straight cylinder, which is defined by its height and diameter, while the second one is more complex, consisting in a succession of different straight cylinders, and requires 5 parameters (see Figure 2)

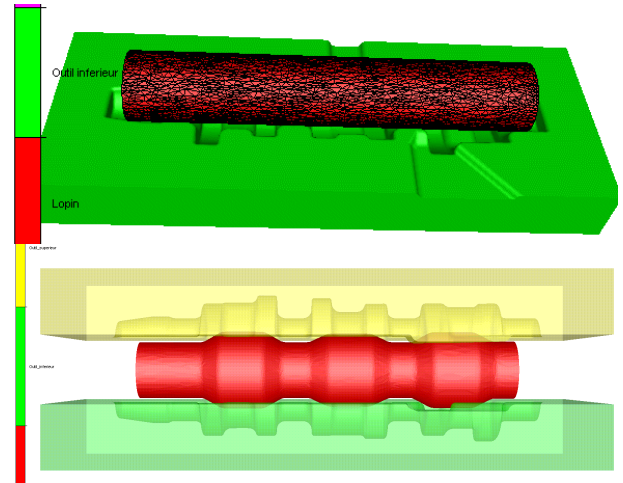

Figure 2: Initial billet parameterize with 2 (top) and 5 (bottom) parameters, and forging dies.

The design aims at minimizing the volume of the material while satisfying the filling of the dies. This constraint is handled by a penalty method. In the 2 parameters case, the 40 F.E. calculations are run on 2 processors, while in the 5 parameters case, the 100 calculations are run on 20 processors: 2 processors for each 3D forging simulation, and 10 optimization simulations run in parallel. The results (see Figure 3) show that the optimization with 5 shape parameters makes it possible to reduce the material weight (5.6 kg) by almost 5%, with respect to the best shape obtained with the two shape parameters optimization (5.8 kg).

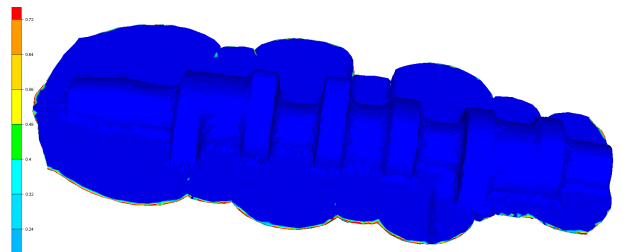

Figure 3: Forge component at the end of the process – The isovalues of contact (all in blue) show that the material is perfectly in contact with the dies.

5. FORGING OF A THICK PLATE

In the second application, the open die forging of an axisymmetric thick plate is considered (see Figure 4). The objective is to optimize the initial geometry of the plate in order to minimize the material weight while overlapping a prescribed geometry at the end of forging (see Figure 5). 5 parameters are necessary to parameterize the preform. In this 2D case, a larger number of calculations is allowed. The 200 simulations are run in parallel on a 10 computers cluster. Figure 5 shows the worst solution randomly found by the algorithm, and the best solution found after 175 calculations. Notice how the gap between the shapes is reduced.

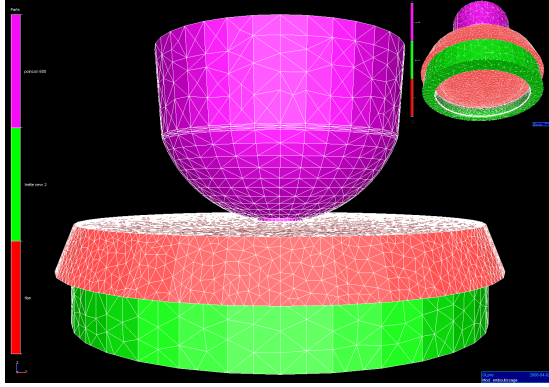

Figure 4: Forging of a thick plate, with punch (top), plate (middle) and die (bottom)

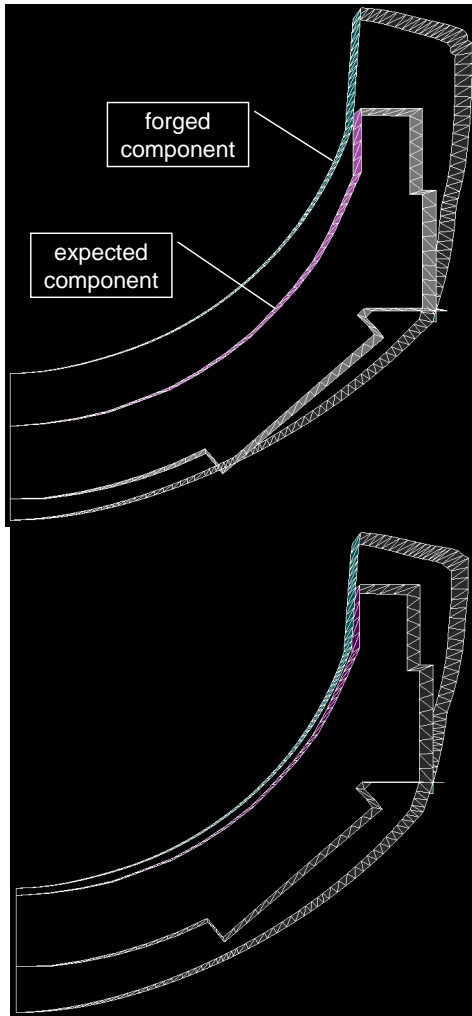

Figure 5: Worst (top) and best (bottom) solutions proposed by the algorithm.

6. FOUR-STEPPED WIRE DRAWING SEQUENCE

The cold wire drawing process consists in reducing the wire section to reach specific final mechanical properties. In order to prevent the formation of cracks

and bursts, it is desired to minimize a damage criterion, here the Latham & Cockcroft (L&C) one, while keeping the targeted diameter of the final wire:

$$D_{LC} = \int_0^{\varepsilon_f} \max(\sigma_I, 0) d\varepsilon_p = LC_{crit} \quad (1)$$

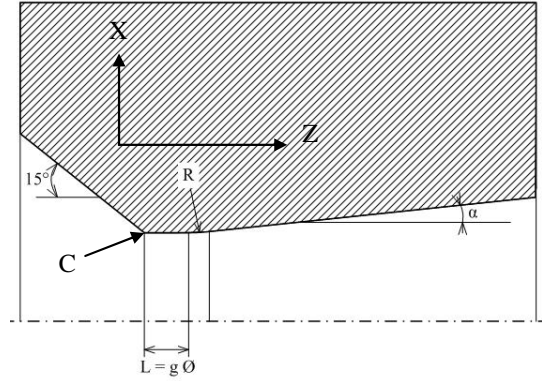

Figure 6: Die geometry and corresponding optimization parameters.

Table 1: Initial shape parameters for a four-stepped wire drawing without optimization

Die	radius R (mm)	Section (mm ²)	Reduction ratio	Land length L (mm)	Entrance 1/2 Die angle α(°)	Value of L&C damage criterion
Die 1	8.9	249	12.23%			1.04
Die 2	7.9	196	21.21%			
Die 3	6.9	150	23.71%			
Die 4	5.9	109	26.89%			
Die 1				2.88		
Die 2				2.55		
Die 3				2.24		
Die 4				1.94		
Die 1					11.72	
Die 2					11.72	
Die 3					11.72	
Die 4					11.72	

The shape parameters regard the geometries of the four dies: reduction ratio, 1/2 die angle α and die length L , as shown in Figure 6. The wire has an initial radius of 9.5 mm. The axisymmetrical four-stepped wire drawing process is simulated by the Forge2007 software. A Tresca law models the friction between wire and die:

$$\tau_c = \bar{m} \frac{\sigma_0}{\sqrt{3}}, \quad \text{with } \bar{m} = 0.02 \quad (2)$$

A first simulation was run with random values of shape parameters to get a damage reference value (see Table 1), which is equal to 1.04. For the optimization procedure, the shape parameters of the 4th die are kept constant, leaving 9 optimization parameters (p_i): the 3 shape parameters of the three first passes. Initial radii are given in Table 1. Only one explicit constraint has to be satisfied, it regards the radii:

$$R_1 > R_2 > R_3 > R_4 \quad (3)$$

Consequently, the bounds on the reduction ratios, ΔR , are turned into bounds on the radii:

$$\begin{cases} -0.9 < \Delta R_1 \leq 0 \\ -0.9 < \Delta R_2 \leq 0 \\ -0.9 < \Delta R_3 \leq 0 \end{cases} \Rightarrow \begin{cases} 7.9\text{mm} < R_1 \leq 8.9\text{mm} \\ 6.9\text{mm} < R_2 \leq 7.9\text{mm} \\ 5.9\text{mm} < R_3 \leq 6.9\text{mm} \end{cases} \quad (4)$$

A large interval of variability is chosen for the two others parameters, the bearing length and the α angle:

$$\begin{cases} 0.5L_{1i} < L_{1f} < 2L_{1i} \\ 0.5L_{2i} < L_{2f} < 2L_{2i} \\ 0.5L_{3i} < L_{3f} < 2L_{3i} \end{cases} \Rightarrow \begin{cases} 1.44\text{mm} < L_1 < 5.77\text{mm} \\ 1.28\text{mm} < L_2 < 5.11\text{mm} \\ 1.12\text{mm} < L_3 < 4.48\text{mm} \end{cases} \quad (5)$$

$$\begin{cases} 0.5d_x < \alpha_1 < 2d_x \\ 0.5d_x < \alpha_2 < 2d_x \\ 0.5d_x < \alpha_3 < 2d_x \end{cases} \Rightarrow \begin{cases} 5.923^\circ < \alpha_1 < 22.538^\circ \\ 5.923^\circ < \alpha_2 < 22.538^\circ \\ 5.923^\circ < \alpha_3 < 22.538^\circ \end{cases} \quad (6)$$

The proposed optimization procedure is run to minimize the damage criterion of equ. (1). 180 F.E. calculations are carried out. The 168th iteration provides the best set of parameters with a damage value of 0.51, which corresponds to the half of the initial value (Table 2)

Table 2: Best set of parameters and corresponding optimal damage value

Shape parameters	p_i	Die	Optimal radius (mm)	Optimal reduction ratio	Optimal land length (mm)	Optimal entrance 1/2 die angle (°)	Optimal damage value
Reduction ratio	p_1	1	8.13	26.76%			0.51
	p_2	2	7	25.87%			
	p_3	3	6	26.53%			
		4	5.9	3.31%			
Land length	p_4	1			1.44		
	p_5	2			2.97		
	p_6	3			4.48		
		4			1.94		
Entrance 1/2 die angle	p_7	1				5.92	
	p_8	2				5.92	
	p_9	3				5.92	
		4				11.72	

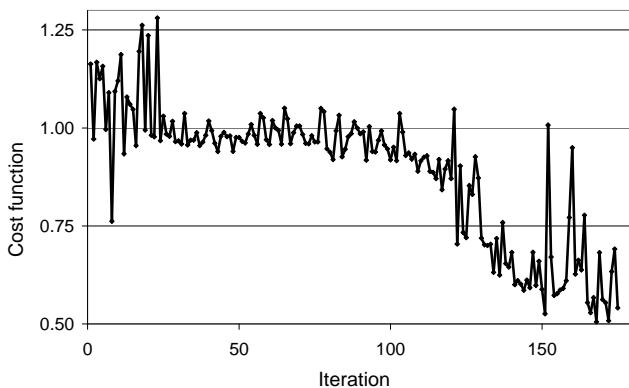

Figure 7: Evolution of the damage objective function during optimization

Looking more precisely to the optimized parameters values, the results seem quite consistent with the usual

expertise. Indeed, the algorithm converges toward constant reduction ratios, except in the last pass. This is explained by the fact that a higher value of the entrance $\frac{1}{2}$ die angle is imposed. Therefore, the optimizer needs to minimize the reduction ratio of this pass, in order to minimize the damage. It is noticed that the optimized values are often on the domain boundaries. This is the case for the entrance die angle, which is constant for the three passes and close to the lower bound (see equ. (6)). Figure 7 shows the evolution of the damage objective function during optimization. 100 iterations are required before making it possible to get a better value than the randomly found initial one. The obtaining of a significantly better solution requires a larger number of calculations, which seems to be well estimated by the maximum allowed number, 180, i.e. 20 times the number of optimization parameters.

These results could be improved by releasing the parameters of the last pass, in order to have a complete 11 parameters optimization (i.e. with only the final radius being kept fixed). A parametric study of friction could also be considered, as the best angle of 6° and the optimal bearing length result in an equilibrium between redundant work and contact length.

7. CONCLUSIONS

Optimization algorithms based on meta-modelling techniques can be applied to actual forging problems. The computational time is well handled by the parallelization of the evolutionary algorithm, in addition to the parallelization of the F.E. software itself. Complex design problems can be tackled, like the forging of a thick plate. With the proposed numerical parameters of the algorithms, the strategy also applies to rather large number of parameters.

ACKNOWLEDGEMENT

This work has been carried out in the frame of the LOGIC ANR program, which support is gratefully acknowledged.

REFERENCES

- [1] M. Emmerich, A. Giotis, M Ozdemir, T. Bäck, K. Giannakoglou, Metamodel-assisted evolution strategies. In: Proceedings of the International Conference on Parallel Problem Solving from Nature, 2002
- [2] L. Fourment, T. T. Do, A. Habbal, M. Bouzaïane, Gradient, non-gradient and hybrid algorithms for optimizing 2D and 3D forging sequences, in: D. Banabic Eds.8th International ESAFORM Conference on Material Forming 2005.
- [3] Bonte M.H.A., Fourment L., Do T.T., van den Boogaard A.H., Huétink J.: Optimisation of metal forming processes using Finite Element simulations, Structural and Multidisciplinary Optimization, submitted